



**UNIVERSITY OF NOVI SAD  
TECHNICAL FACULTY  
"MIHAJLO PUPIN"  
ZRENJANIN**



**ITROCONFERENCE<sup>12</sup>**

INFORMATION TECHNOLOGY AND EDUCATION DEVELOPMENT



**ITROCONFERENCE<sup>12</sup>**

INFORMATION TECHNOLOGY AND EDUCATION DEVELOPMENT



**PROCEEDINGS**

**ZRENJANIN, November 2021**



UNIVERSITY OF NOVI SAD  
TECHNICAL FACULTY "MIHAJLO PUPIN"  
ZRENJANIN  
REPUBLIC OF SERBIA



XII INTERNATIONAL CONFERENCE OF  
**INFORMATION TECHNOLOGY AND  
DEVELOPMENT OF EDUCATION**  
**ITRO 2021**  
PROCEEDINGS OF PAPERS

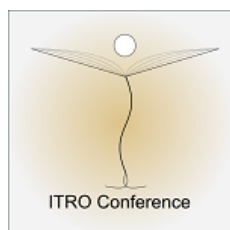

XII MEĐUNARODNA KONFERENCIJA  
**INFORMACIONE TEHNOLOGIJE I  
RAZVOJ OBRAZOVANJA**  
**ITRO 2021**  
ZBORNİK RADOVA

ZRENJANIN, NOVEMBER 2021

Publisher and Organiser of the Conference:

**University of Novi Sad, Technical faculty „Mihajlo Pupin“, Zrenjanin,  
Republic of Serbia**

For publisher:

**Dragica Radosav, Ph. D, Professor,  
Dean of the Technical faculty „Mihajlo Pupin“, Zrenjanin, Republic of Serbia**

Editor in Cheaf - President of OC ITRO 2021:

**Snežana Jokić, Ph. D, Assistant Professor**

Proceedings editor:

**Snežana Jokić, Ph. D, Assistant Professor**

Technical design:

**Maja Gaborov MSc, Assistant  
Aleksandra Stojkov MSc, Assistant  
Nemanja Tasić MSc, Assistant**

Circulation: **50**

**ISBN: 978-86-7672-351-5**

CIP - Каталогизacija u publikaciji  
Biblioteke Maticе српске, Нови Сад

37.01:004(082)(0.034.2)

37.02(082)(0.034.2)

INTERNATIONAL Conference of Information Technology and Development of Education  
ITRO (12 ; 2021 ; Zrenjanin)

Proceedings of papers [Elektronski izvor] / XII International Conference of Information  
Technology and Development of Education ITRO 2021 = Zbornik radova / XII  
međunarodna konferencija Informacione tehnologije i razvoj obrazovanja ITRO 2021,  
Zrenjanin, November 2021. - Zrenjanin : Technical Faculty "Mihajlo Pupin", 2022. - 1  
elektronski optički disk (CD-ROM) : tekst, slika ; 12 cm

Sistemske zahteve: Nisu navedeni. - Nasl. sa naslovnog ekrana. - Elektronska publikacija u  
formatu pdf opsega IX, 238 str. - Tiraž 50. - Bibliografija uz svaki rad

ISBN 978-86-7672-351-5

а) Информационе технологије -- образовање -- Зборници б) Образовна технологија --  
Зборници

COBISS.SR-ID 66049033

## PARTNERS INTERNATIONAL CONFERENCE

**South-West University „Neofit Rilski”  
Faculty of Education, Blagoevgrad,  
Republic of Bulgaria**



**SOUTH WEST UNIVERSITY  
“NEOFIT RILSKI”**

**Technical University of Košice  
Faculty of Electrical Engineering and Informatics  
Slovak Republic**

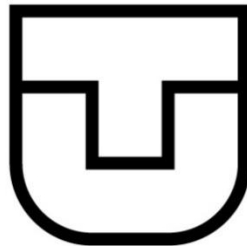

**University Goce Delcev Stip  
Republic of Macedonia**



## THE SCIENCE COMMITTEE:

Marina Čičin Šain, Ph.D, Professor, University of Rijeka, Croatia  
Sashko Plachkov, Ph.D, Professor, South-West University "Neofit Rilski" /Department of Education, Blagoevgrad, Republic of Bulgaria  
Sulejman Meta, Ph.D, Professor, Faculty of Applied Sciences, Tetovo, Macedonia  
Márta Takács, Ph.D, Professor, Óbuda University, John von Neumann Faculty of Informatics, Budapest, Hungary  
Nina Bijedić, Ph.D, Professor, Applied mathematics, Bosnia and Herzegovina  
Mirjana Segedinac, Ph.D, Professor, Faculty of Science, Novi Sad, Serbia  
Milka Oljača, Ph.D, Professor, Faculty of Philosophy, Novi Sad, Serbia  
Dušan Starčević, Ph.D, Professor, Faculty of Organizational Sciences, Belgrade, Serbia  
Josip Ivanović, PhD, Professor, Hungarian Language Teacher Training Faculty, Subotica, Serbia  
Ivanka Georgieva, Ph.D, South-West University "Neofit Rilski", Faculty of Engineering, Blagoevgrad, Republic of Bulgaria  
Miodrag Ivković, Ph.D, Professor, Technical Faculty "Mihajlo Pupin" Zrenjanin, Serbia  
Momčilo Bjelica, Ph.D, Professor, Technical Faculty "Mihajlo Pupin" Zrenjanin, Serbia  
Dragica Radosav, Ph.D, Professor, Technical Faculty "Mihajlo Pupin" Zrenjanin, Serbia  
Dragana Glušac, Ph.D, Professor, Technical Faculty "Mihajlo Pupin" Zrenjanin, Serbia  
Dijana Karuović, Ph.D, Professor, Technical Faculty "Mihajlo Pupin" Zrenjanin, Serbia  
Ivan Tasić, Ph.D, Professor, Technical Faculty "Mihajlo Pupin" Zrenjanin, Serbia  
Vesna Makitan, Ph.D, Assistant Professor, Technical Faculty "Mihajlo Pupin" Zrenjanin, Serbia  
Marjana Pardanjac, Ph.D, Professor, Technical Faculty "Mihajlo Pupin" Zrenjanin, Serbia  
Snežana Babić Kekez, Ph.D, Professor, Technical Faculty "Mihajlo Pupin" Zrenjanin, Serbia  
Stojanov Željko, Ph.D, Professor, Technical Faculty "Mihajlo Pupin" Zrenjanin, Serbia  
Brтка Vladimir, Ph.D, Professor, Technical Faculty "Mihajlo Pupin" Zrenjanin, Serbia  
Kazi Ljubica, Ph.D, Assistant Professor, Technical Faculty "Mihajlo Pupin" Zrenjanin, Serbia  
Berković Ivana, Ph.D, Professor, Technical Faculty "Mihajlo Pupin" Zrenjanin, Serbia  
Nikolić Milan, Ph.D, Professor, Technical Faculty "Mihajlo Pupin" Zrenjanin, Serbia  
Dalibor Dobrilović, Ph.D, Professor, Technical Faculty "Mihajlo Pupin" Zrenjanin, Serbia  
Anja Žnidaršič, Ph.D Professor, Faculty of Organizational Sciences, Kranj, Slovenia  
Janja Jerebic, Ph.D Professor, Faculty of Organizational Sciences, Kranj, Slovenia  
Mirjana Kocaleva, Ph.D Professor, Faculty of Informatics, University "Goce Delčev", Štip, North Macedonia  
Tatjana Grbić, Ph.D Professor, Faculty of Technical Sciences, Novi Sad, Serbia  
Slavica Medić, Ph.D Professor, Faculty of Technical Sciences, Novi Sad, Serbia  
Gordana Jotanović, Ph.D Professor, Faculty of Transport and Traffic Engineering, Doboj, BIH  
Đurđa Grijak, Ph.D Professor, Technical Faculty "Mihajlo Pupin" Zrenjanin, Serbia  
Bojana Perić Prkosovački, Ph.D Professor, Technical Faculty "Mihajlo Pupin" Zrenjanin, Serbia  
Snežana Jokić, Ph.D, Assistant Professor, Technical Faculty "Mihajlo Pupin" Zrenjanin, Serbia  
Stojanov Jelena, Ph.D, Assistant Professor, Technical Faculty "Mihajlo Pupin" Zrenjanin, Serbia

**THE ORGANIZING COMMITTEE:**

**Snežana Jokić**, Ph.D, Ass. Professor, Technical Faculty "Mihajlo Pupin" Zrenjanin, R. of Serbia  
- Chairman of the Conference ITRO 2020

Dragica Radosav, Ph.D, Professor, Technical Faculty "Mihajlo Pupin" Zrenjanin, R. of Serbia

Dragana Glušac, Ph.D, Professor, Technical Faculty "Mihajlo Pupin" Zrenjanin, R. of Serbia

Dijana Karuović, Ph.D, Professor, Technical Faculty "Mihajlo Pupin" Zrenjanin, R. of Serbia

Marjana Pardanjac, Ph.D, Professor, Technical Faculty "Mihajlo Pupin" Zrenjanin, R. of Serbia

Jelena Stojanov, Ph.D, Ass. Professor, Technical Faculty "Mihajlo Pupin" Zrenjanin, R. of Serbia

Vesna Makitan, Ph.D, Ass. Professor, Technical Faculty "Mihajlo Pupin" Zrenjanin, R. of Serbia

Đurđa Grijak, Ph.D Professor, Technical Faculty "Mihajlo Pupin" Zrenjanin, Serbia

Bojana Perić Prkosovački, Ph.D Professor, Technical Faculty "Mihajlo Pupin" Zrenjanin, Serbia

Maja Gaborov, MSc, Assistant, Technical Faculty "Mihajlo Pupin" Zrenjanin, R. of Serbia

Nemanja Tasić, MSc, Assistant, Technical Faculty "Mihajlo Pupin" Zrenjanin, R. of Serbia

Aleksandra Stojkov MSc, Assistant, Technical Faculty "Mihajlo Pupin" Zrenjanin, R. of Serbia

*All rights reserved. No part of this Proceeding may be reproduced in any form without written permission from the publisher.*

*The editor and the publisher are not responsible either for the statements made or for the opinion expressed in this publication.*

*The authors are solely responsible for the content of the papers and any copyrights, which are related to the content of the papers.*

*With this publication, the CD with all papers from the International Conference on Information Technology and Development of Education, ITRO 2020 is also published.*

## INTRODUCTION

This Proceedings of papers consists from full papers from the International conference "Information technology and development of education" - ITRO 2021, that was held at the Technical Faculty "Mihajlo Pupin" in Zrenjanin on November 26th 2021.

**The International conference on Information technology and development of education** has had a goal to contribute to the development of education in Serbia and the Region, as well as, to gather experts from natural and technical sciences' teaching fields.

The expected scientific-skilled analysis of the accomplishment in the field of the contemporary information and communication technologies, as well as analysis of state, needs and tendencies in education all around the world and in our country has been realized.

The authors and the participants of the Conference have dealt with the following thematic areas:

- Education in crisis situations
- Educational challenges
- Theoretic and methodology questions of contemporary pedagogy
- Digital didactics of media
- Modern communication in teaching
- Curriculum of contemporary teaching
- E-learning
- Education management
- Methodic questions of natural and technical sciences subject teaching
- Information and communication technologies

All submitted papers have been reviewed by at least two independent members of the Science Committee. There were total of 94 authors that took part at the Conference from 12 countries, 3 continents: 52 from the Republic of Serbia and 42 from foreign countries such as: Macedonia, Bosnia and Herzegovina, Hungary, Slovakia, India, Bulgaria, Rumania, Albania, USA, Canada, Malaysia. They were presented 49 scientific papers.

The papers presented at the Conference and published in Proceedings can be useful for teachers while learning and teaching in the fields of informatics, technics and other teaching subjects and activities. Contribution to the science and teaching development in this Region and wider has been achieved in this way.

The ITRO Organizing Committee would like to thank the authors of papers, reviewers and participants in the Conference who have contributed to its tradition and successful realization.

Chairman of the Organizing Committee  
Snežana Jokić, Ph.D, Ass. Professor

## CONTENTS

### INVITED LECTURE

D. Sladić, A. Radulović, M.Zarić, B. Markoski IMPORTANCE OF LEARNING SOA IN MODERN GIS LECTURES.....	2
---	---

### SCIENTIFIC PAPERS

Ž. Namestovski, A. Buda, G. Molnár, Z. Szűts SOCIAL ASPECTS OF DISTANCE LEARNING DURING THE COVID-19 PANDEMIC.....	9
M. Gaborov, D. Karuović, M. Kavalić, D. Milosavljev, S. Stanisavljev, J. Bushvati COVID 19 AND ONLINE LEARNING PLATFORMS.....	13
M. Majstorović, D. Radosav DISTANCE LEARNING FROM THE PERSPECTIVE OF STUDENTS DURING THE COVID-19 PANDEMIC.....	16
A. Mamić, M. Blagojević, T. Đuričić ANALYSIS OF LMS USED IN THE PROCESS OF DISTANCE LEARNING IN PRIMARY EDUCATION, DURING THE COVID 19 PANDEMIC.....	20
R. Zamurović, D. Radosav VIDEO GAMES AS A PROMISING EDUCATIONAL OPTION FOR ALL AGES.....	27
E. Karamazova, M. Kocaleva CASE STUDY: WHICH MATH TOPICS STUDENTS HAVE A PROBLEM WITH WHEN THEY START UNIVERSITY STUDYING.....	34
D. Bikov, B. Shterjev, D. Siracheski USE OF EDUCATIONAL HARDWARE AND SOFTWARE TO ENCOURAGE CHILDREN TO CODE.....	38
M. Kavalić, M. Pečujlija, S. Stanisavljev, D. Milosavljev, M. Gaborov, M. Bakator LOCUS OF CONTROL IN THE FUNCTION OF STUDENTS' ACADEMIC SUCCESS.....	43
B. Saliu DISCUSSION THREAD ON GOOGLE CLASSROOM AND GROUP COMMUNICATION: A CASE STUDY OF LANGUAGE CENTER STUDENTS.....	48
D. Kreculj, M. Gaborov, N. Ratkovic Kovacevic, V. Nikolic, S. Minic, N. Cvorovic IMPLEMENTATION OF DRONES IN TEACHING.....	53
E. Pavlova Tosheva THE EVOLUTION OF WEB BASED LEARNING PLATFORMS.....	60
M. Kocaleva, E. Karamazova, B. Zlatanovska, D. Karuović MOBILE TEACHING AND LEARNING – BENEFITS, PERSPECTIVE AND CHALLENGES.....	64
G. Škondrić, I. Hamulić, E. Junuz LMS CONCEPTUAL MODEL THAT RECOGNIZE ALL FORMS OF LEARNING OUTCOMES.....	67
S. Šević, D. Glušac PEDAGOGICAL DIMENSION OF TEACHING INFORMATICS AND COMPUTING.....	70
S. Jokić, V. Srdić, I. Kostovski THE INFLUENCE OF ETOS ON THE QUALITY OF SCHOOL WORK.....	75



C.M. Bande, A.Stojanova, N.Stojkovikj, M.Kocaleva, L.K.Lazarova, B. Zlatanovska LEARNING DATA MINING COURSE USING LANGUAGE R.....	79
N.Stojkovikj, A. Stojanova , L. K. Lazarova, M. Miteva AGENT-BASED MODELLING AND SIMULATION.....	87
M. Kocaleva, B. Zlatanovska, E. Karamazova, N. Stojkovikj, A. Stojanova USING WEKA FOR FINDING OUTPUT FOR GIVEN FUNCTION.....	93
A. Mamić, M. Blagojević, T. Đuričić ANALYSIS OF THE REPRESENTATION OF OBJECT-ORIENTED PROGRAMMING LANGUAGES IN PRIMARY EDUCATION.....	97
D. Krstev, A. Krstev, S. Dimitrov DATA PROCESSING USING ANALYTICAL HIERARCHICAL PROCESS IN REAL CIRCUMSTANCES.....	104
S.Mrđen, E. Brtka, V. Makitan COMPARISON OF C ++ AND PYTHON PROGRAMMING LANGUAGES IN TEACHING.....	108
I. Borjanovic THE VIRTUAL PHYSICS LABORATORY.....	112
S. Jokic, A. Ilic, M. Hadzic, V. Srdić METHODOLOGICAL APPROACH TO ELECTRICITY PRODUCTION WITHIN THE FIELD 'RESOURCES AND PRODUCTION' IN 8 <sup>TH</sup> GRADE OF PRIMARY SCHOOL.....	115
L.K. Lazarova, M.Miteva , A.Stojanova MODERNIZATION OF MATHEMATICS EDUCATION BY USING EDUCATIONAL E-PLATFORMS.....	121
I. Hamulić, G. Škondrić, E. Junuz DYNAMIC SOCIAL NETWORK ANALYSIS VISUALIZATION SOFTWARE: A COMPARATIVE REVIEW.....	126
Lj. Kazi, D. Radosav, N. Chotaliya USABILITY EVALUATION FRAMEWORK FOR WEB PORTALS OF TECHNICAL SCIENCES HIGHER EDUCATION INSTITUTIONS: A CASE STUDY WITH SERBIAN STATE UNIVERSITIES.....	129
S. Mrđen, E. Brtka, V. Makitan, M. Sisak EXAMPLE OF AN APPLICATION IN THE PYTHON PROGRAMMING LANGUAGE....	135
M. Živić, M. Pardanjac, J. Barbarić APPLICATION OF 3D PRINTING IN EDUCATION.....	139
N. Koceska, S. Koceski VIRTUAL LABORATORY AS PROGRESSIVE WEB APPLICATION.....	142
S. Dimitrov, D. Krstev, A. Krstev IMPROVEMENT OF THE STATIC CHARACTERISTICS OF PILOT OPERATED PRESSURE RELIEF VALVES.....	147
M. Kocaleva, B. Petrovska, N. Stojkovikj, A. Stojanova, B. Zlatanovska REVIEW OF SENTINEL-2 APPLICATIONS.....	155

S. Arsovski, B. Markoski, V. Premceviski, P. Vasiljevic, A. Sofic REVIEW ON DEEP LEARNING ARCHITECTURES.....	160
M. Bakator, D. Radosav. N. Đalić, S. Stanisavljev, D. Milosavljev, E. Terek Stojanović THE ROLE OF ADVANCED ICTS IN EFFECTIVE CRM.....	168
D. Banović, Z. Kazi ELECTRONIC APPLICATION OF CHILDREN FOR ENROLLMENT IN PRESCHOOL INSTITUTION.....	173
T. Milić, I. Berković, E. Brtko, I. Vecštejn, K. Ivanović THE USE OF WEB TOOLS 2.0 IN EDUCATION.....	178
B. Sobota, P. Lovas, Š. Korečko, M. Mattová VIRTUAL REALITY TECHNOLOGIES USAGE IN THE AREA OF MANAGEMENT AND THERAPY OF PHOBIAS AND COGNI-TIVE ABILITIES.....	182
B. Sobota, M. Mattová, J. Bogušćiak, M. Hudák, Š. Korečko WHEELCHAIR SIMULATOR IN WEB VIRTUAL REALITY.....	187
S. Stanisavljev, D. Radosav, Z. Košut, S. Jokić, J. Vukajlović, S. Zec IMPORTANCE OF EMPLOYEE TRAINING FOR INDUSTRY 4.0.....	192
A. Krstev, A. Velkova Krstev THE IMPACT OF AUGMENTED REALITY IN ARCHITECTURAL DESIGN USING COMBINED METHOD OF DATA AGGREGATION AND SEGREGATION.....	196
D. Krstev, S. Dimitrov, A. Krstev* VEHICLE ROUTING PROBLEM WITH DISTANCE CONSTRAINTS AND CLUSTERING USING MATLAB.....	200
A. Velinov, N. Koceska, S. Koceski APPLICATION OF THE MQTT PROTOCOL IN TELEPRESENCE ROBOTS.....	205
R. Timovski, S. Koceski, N. Koceska CREATING 3D OBJECTS USING PHOTOGRAMMETRY.....	210
M. Gaborov, S. Popov, D. Karuović, D. Radosav, D. Milosavljev, E. Terek-Stojanović THE APPLICATION OF SCRUM IN COMPANIES: A SYSTEMATIC LITERATURE REVIEW.....	216
M. Knežević, N. Bobinac DIGITAL MARKETING OF AGRICULTURAL HOLDING IN REPUBLIC OF SERBIA....	221
M. Knežević, N. Bobinac TESTING USING SELENIUM.....	224
M. Kavalić, M. Pećujlija, Ž. Stojanović, S. Stanisavljev, M. Bakator THE EFFECTS OF LOCUS OF CONTROL ON ENTREPRENEURIAL BEHAVIOR.....	228
M. Knežević APPLICATION FOR GRAPE SALES.....	233
M. Knežević, N. Bobinac GRAPE VINE PROTECTION RECORD OF AN AGRICULTURAL HOLDING IN REPUBLIC OF SERBIA.....	236

***INVITED  
LECTURE***

# Importance of Learning SOA in Modern GIS Lectures

D. Sladić\*, A. Radulović\*, M. Zarić\*, B. Markoski\*\*

\* University of Novi Sad, Faculty of Technical Sciences, Novi Sad, Serbia

\*\* University of Novi Sad/Technical Faculty Mihajlo Pupin, Zrenjanin, Serbia  
{dudab, sanjica, miroslavzadic, markoni}@uns.ac.rs

**Abstract** – Dissemination of geospatial data has large importance in promoting its use to the wider audience rather than the narrow group of experts. Geospatial data is acquired through various surveying techniques and technologies such as GNSS, LiDAR, remote sensing, photogrammetry, etc. However, to promote its use and make it publicly available, modern Web technologies are used. To bridge the communication gap between the two group of domain experts (geospatial and web) it is necessary to develop a methodology which will connect these two areas. The aim of the paper is to demonstrate a theoretical framework and a stack of technologies necessary to adopt the basic concepts of web development domain in the field of geoinformatics and AEC in general. The case study is demonstrated on the student project performed in the curriculum at the Master studies of Geodesy and Geoinformatics, University of Novi Sad.

## I. INTRODUCTION

While Web development is well known to the experts and students in the field of computer science and software engineering, it is relatively unknown to the experts from the field of geodesy and AEC (architecture, engineering and construction) domain in general. The purpose of introducing basic concepts and technologies of the Web development to the geodetic audience is to fill the knowledge and communication gap between these two groups of experts. Domain experts are more competent in perceiving the requirements in terms of data dissemination and presentation but lack skills to perceive the process of development and possibilities of the technologies underpinning the entire process. On the other hand, IT experts lack knowledge about the domain and its potential needs. This way, a vast amount of potential uses of geospatial data is lost. Many years of experience in bringing information technologies to the geospatial domain in the field of geoinformatics have shown that this approach brings results and geospatial data finds increasing use through the development of various applications. The purpose of the paper is to share this experience through demonstrating the theoretical and practical content of the course called

Geoportals and Geospatial Services at Master studies of Geodesy and Geoinformatics, Faculty of Technical Sciences, University of Novi Sad. It also demonstrates how the topic is methodically presented and introduced to the students that are not very familiar with programming and informatics to a greater extent.

The paper is structured as follows: after the introduction in Section 1, Section 2 presents theoretical aspect of the service-oriented architecture of spatial data infrastructures and geoportals. Section 3 presents practical approach that is used to demonstrate the basic theoretical concepts in the form of a student project. Conclusions and future improvements are given afterwards.

## II. THE ROLE OF SERVICE ORIENTED ARCHITECTURE IN GEOSPATIAL DOMAIN

### A. *Service-oriented architecture*

Service Oriented Architecture (SOA) is a distributed computing architecture based on weakly coupled service interactions in which a service interaction model shows the interaction between different agents for publishing, finding, and invoking services. This model is also called the publish-find-bind model and includes publishing resource descriptions so that they are available to users, finding resources of interest based on set of criteria and interacting with the resource provider in the goal of accessing the desired resource (binding) [1]. Within such an architecture, a key role is played by a service that is a register of available resources whose purpose is to mediate between users and providers through enabling the publication and search of content. This allows users to dynamically find and communicate with the appropriate resource provider without knowing in advance of its existence. The advantage of using this architecture is that monolithic software applications are replaced

by weakly coupled services that can be reused and combined in different application domains. These services are compliant with standards so that users do not depend solely on one manufacturer.

Geospatial services can be defined as modular applications that contain and describe themselves and consist of a set of operations, accessible through interfaces, that allow clients to invoke the behavior that the user wants. Clients can invoke services over a network using standardized protocols regardless of the language, object model, or platform on which the services or client are installed. If applications are created according to common interfaces, they can be created without dependence, before or during execution, on other applications or services. Applications and services can be added, modified, or replaced without affecting other applications. The operational flow of activities can be changed during execution, enabling a quick response to time-critical situations. This weakly coupled approach based on standards, can produce highly adaptable systems, that is, systems that can be flexibly adapted to changing requirements and technologies.

Geospatial services are RESTful Web services [2] that implement OGC standards [3] for the service interface. Representational State Transfer (REST) is a software architecture for distributed systems such as the WWW [4]. Although the WSDL standard is intended for Web service specification [5], REST has taken a leading role in the field of geoinformation, so the OGC consortium has adopted it as the basis for developing OGC specifications. RESTful services are based on the HTTP protocol and use HTTP methods such as GET and POST to send client requests to the server in a client-server architecture [6].

SOA provides a technical framework for the development of Spatial Data Infrastructures (SDI)[7]. SDI is defined as a framework of policies, institutional arrangements, technologies, data, and people that enables the sharing and effective usage of geospatial information by standardizing formats and protocols for access and interoperability [8]. SDI services are part of a distributed system based on SOA, through the implementation of a three-tier architecture of a distributed geospatial information system consisting of three tiers:

- Data tier - contains data in a database or file system.
- Service tier - implements services that mediate between the data tier and the application tier, by accessing the data tier at the user's request, downloading data,

processing (in the form of map rendering, data filtering, coordinate transformation, etc.) and delivering the result to the end user.

- Application tier - a set of applications that access services. These applications can run in a web browser (so-called thin client) or can be desktop applications (so-called thick client) that have support for standard interfaces.

Figure 1 shows a system that is organized as a three-tier service-oriented architecture. The first tier contains user applications that request response from services located in the second tier, and these services rely on data stored in the third tier (usually databases or a file system).

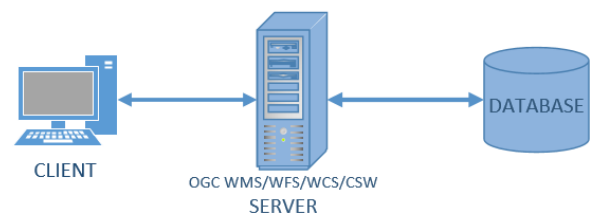

Figure II. Three-tier architecture

From the user's point of view, the services follow the process that goes from finding geospatial data, through evaluation and access, to their exploitation, i.e. use. Finding geospatial data involves using services such as metadata catalogs [9] to find data of interest to a particular geographic region. Evaluation includes detailed reports, data samples, and visualizations (e.g., through web mapping, or simple vector representation of data) to help the user determine if such data suits him. Access involves ordering, packaging and delivery, offline or online, of the requested data (where the coordinates and attributes are according to the data form). Finally, exploitation (use) means what the user does with the data for their own needs.

The geospatial data infrastructure includes services that help find and interact with data. These services are divided into three types: discovery services, access services and processing services. Search and retrieval services for geospatial resources include metadata catalog services. Data access services include raster data access services and vector data access services. Processing services include services for data visualization and web map creation, coordinate transformation, image classification and many others. All these services are based on the standards. For example, the composition of services for access to vector (Web Feature Service - WFS) [10] and raster (Web

Coverage Service - WCS) [11] geospatial data and visualization service (Web Map Service - WMS) [12] is performed to display data from different sources.

In a distributed environment, users are allowed to use different applications, if they implement the same standards and connect on the same application layer. Such applications can be used to display and visualize data from a web map service and can also allow data to be updated and searched. These tools are able to connect to the server through common data download interfaces for visualization or updating. In this way, users can use a variety of tools without worrying about data conversion, which is a key advantage of a standard-based service approach.

The service approach provides a number of advantages, and one of them is the reduction of development costs, because not all components are developed, but only those that were not previously developed, which promotes the reuse of components or services. They also allow to hide complexity, develop applications on already built parts and focus only on the application, i.e., business needs and the development of user applications. Only the services needed for a particular application are integrated, and if the available services are not needed, it is not necessary to buy or use them. End users require simplicity and interoperability (so-called plug & play access). The Web is a very heterogeneous environment, and the costs of building and achieving interoperability are high, so it is necessary to rely on an infrastructure built on services based on open standards.

#### *B. INSPIRE and NSDI*

INSPIRE (INfrastructure for SPatial Information Information in Europe initiative) is an initiative launched, developed, and adopted as a directive by the European Union on 14 March 2007, in cooperation with Member States and associated countries. The purpose of the directive is to define the basic rules aimed at establishing the Spatial Information Infrastructure in the European Union for the needs of Community environmental policies and the needs of policies and activities that may have an impact on the environment [13]. The basic components of the INSPIRE Directive to be adopted set out in its implementing rules are divided into:

- Metadata - information about geospatial data and services, such as the topic of the geospatial data set, quality, origin, scope, etc.

- Data specifications - harmonization of geoinformation with reference to content and position,
- Network services - technology and standards under which geoinformation and metadata are available over the Internet,
- Data and service exchange - conditions, including those under which geoinformation is available,
- Monitoring and reporting - reporting and monitoring the implementation of INSPIRE.

The National Geospatial Data Infrastructure (NSDI) represents the strategy, technologies, rules, standards and human resources required for the collection, processing, storage, access, exchange and optimal use of geospatial data of the Republic of Serbia [14]. NSDI refers to digital geospatial data and appropriate geospatial data services for the territory of the Republic of Serbia which are under the jurisdiction of: state administration bodies, local self-government bodies, public companies and legal entities entrusted with geodata management, use of data and services and provision of public services based on these geospatial data. The establishment of the NSDI includes formation of metadata for geospatial datasets and services, formation of geospatial datasets and geodatabases, formation of geospatial data services, networking technology. Maintaining NSDI involves updating data and ensuring the functioning of services and technologies. NSDI contains metadata, services and sets of geospatial data on cadastral parcels, addresses, environmental protection, hydrography, transport networks, administrative units, land cover, elevation, etc. Through this geoportal, a public metadata service is maintained and provides users with links to other services included in the NSDI, as well as finding, accessing and using geospatial data.

The national geospatial data infrastructure is the connection and exchange of harmonized data from different sources from different data owners that are easily accessible to users via the Internet. The NSDI components include geospatial data, metadata, services, standards and the institutional framework, i.e. the basic SDI components. The technical framework (TF) of NSDI specifies basic standards for data and services and serves as a basis for the implementation of standards within the NSDI. The main goal of the TF is to identify the basic standards related to data exchange within the NSDI, the services offered within the NSDI and the standards they support. Requirements for partners for cooperation within the NSDI in accordance with digital rights management and documentation of

data sets and services are also presented. By focusing on the technical aspect of NSDI, the TF provides a basis for the implementation of standards covering NSDI. The result is a recommendation of a set of standards that will meet the specific requirements of the NSDI basis. TF follows the three basic pillars of INSPIRE: metadata, information models for geospatial data and network services based on the principles of SOA. Another important aspect is management of geospatial digital rights GeoDRM (Geospatial Digital Rights Management).

### C. Implementation Technologies

Technical implementation of NSDI is realized using web development technologies. Front-end web development deals with that part of the site or web application that is displayed in the web browser. Front-end development refers to the development of web applications in which a significant part of the functionality is based on the front end. This requires a thorough knowledge of the JavaScript programming language. Web design is used to design web pages for better user experience and uses HTML, CSS, as well as tools such as Photoshop, Adobe XD, etc. Geospatial web applications are mainly focused on the implementation of the required functionalities and are less oriented towards web design. Therefore, the primary focus is on JavaScript and JavaScript libraries and frameworks with the necessary knowledge of HTML and CSS. JavaScript libraries and frameworks used for the development of geoportals are presented in Table 1.

TABLE I. JAVASCRIPT LIBRARIES AND FRAMEWORKS

JavaScript libraries and frameworks		
DOM/UI	2D Geospatial	3D visualisation
jQuery	OpenLayers	D3.js
Bootsrap	GoogleMaps	HighCharts
Angular	Here maps	Three.js
React	Leaflet	Babylon.js
Vue	...	A-frame
...		Cesium
		...

Figure 2 shows 3D point cloud data from the Laboratory of Geoinformatics [15] visualized in a web browser, as an example of using JavaScript library for the 3D visualization of geospatial data.



Figure 2. 3D point cloud for the city of Novi Sad

To communicate with a backend on a remote server, AJAX is used to enable asynchronous communication with a web server. It allows reading data from a web server - after the page is loaded and updating the web page without reloading the page. Data is sent to a web server in the background. It uses a combination of XMLHttpRequest object built into the browser to search for data from a web server and JavaScript and HTML DOM to display or use data. AJAX allows websites to be updated asynchronously by exchanging data with the web server behind the scenes. This means that it is possible to update parts of the web page without reloading the entire page. Format used for data exchange between client and server is JSON. It is a text, written in JavaScript object notation. It is a universal format on the web. When data is exchanged between a browser and a server, the data can only be text. Hence the JSON is text. Any JavaScript object can be converted to JSON and sent to the server. The JSON obtained from the server can be converted to JavaScript objects. This way, we can work with JavaScript objects, without complicated parsing and translation. Geospatial extension of JSON called GeoJSON is a format for encoding various geospatial data structures. GeoJSON supports the following types of geometry: Point, LineString, Polygon, MultiPoint, MultiLineString, and MultiPolygon. Geometric objects with additional properties (attributes) are called Features, while classes of feature objects are called FeatureTypes. Feature sets of the same class are contained in FeatureCollection objects.

Back-end web development deals with the business logic that runs on the server and communicates directly with the database, while giving the client side an interface to access that data. It covers a wide range of technologies, from the script that runs the contact form on the site to some of the most complex software systems. It uses programming languages such as Java, .Net, Python, etc. and development environments such as Spring

Boot, relational databases and SQL, object relational mapping such as Java Persistence API (JPA), etc.

### III. DEVELOPMENT OF A4GEO GEOPORTAL

A case study related to the education in the field of SDI and Geoportals will be shown on the example of the development of A4GEO geoportal that is implemented as a student project in the course called Geoportals and Geospatial Services at Master studies of Geodesy and Geoinformatics, Faculty of Technical Sciences, University of Novi Sad. The implementation is based on three-tier architecture shown on Figure 2.

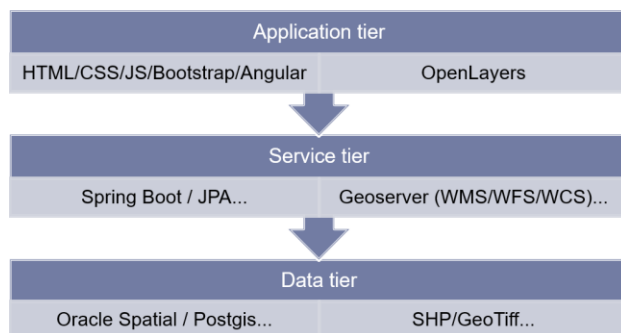

Figure 3. Three-tier architecture of A4GEO project

#### A. Database development

Data tier is implemented using PostgreSQL/Postgis relational database management system. It uses SQL which is a standard language for storing, querying and retrieving data from a database. It is intended for data management in relational database management systems. It includes data insert, queries, updating and deleting, creating and modifying schemas, as well as data for access control. SQL is a relational query language. It is uniform, because all data and results of operations are presented in the form of a table.

Cadastral datasets are loaded into the PostgreSQL to form cadastral database. Cadastral database contains two parts: alphanumeric and graphic part. Alphanumeric dataset contains plain alphanumeric data about properties, rights (such as ownership rights) and right holders. Graphic dataset is a cadastral map. It contains 2D representation of parcel and building boundaries (polygons). This geospatial data can be stored in shapefiles or Postgis database (geospatial extension of PostgreSQL).

#### B. A4GEO Back-end development and Rest services

A4GEO project uses two different solutions for the back-end development. To access and visualize geospatial data of cadastral maps an open-source solution GeoServer [16] is used. It is used to deliver geospatial data through WMS and WFS interface. GeoServer is an open-source server for exchanging geospatial data which publishes data from all important spatial data sources using open standards. It supports OGC WMS, WFS, WCS open standards. Its main goal is interoperability.

Alphanumeric data is accessed through Rest services developed in Spring Boot environment [17]. The Spring environment provides a comprehensive model for programming and configuring modern Java-based business applications on any type of executive platform.

A key element of Spring is infrastructure support at the application level. Spring focuses on the structure of business applications so that teams can focus on business logic at the application level, without unnecessarily dealing with specifics of the execution environments. Spring Boot goes a step further by allowing easy development of Spring-based applications that can "just run", with minimal configuration, which makes very easy to setup the project. Spring also simplifies work with rest services that send data in JSON format. Object-relational mapping is also used to avoid writing SQL and accelerated the process of development. Java Persistence API (JPA) is a Java API that enables the management of relational data (data from relational databases) in object-oriented applications written in the Java programming language. It supports basic CRUD (Create / Read / Update / Delete) operations.

#### C. A4GEO Frontend

A4GEO frontend is developed in an Angular framework [18]. Angular framework uses Angular CLI, a command line tool for managing the application development cycle in Angular. CLI is used to create the initial file system of the Angular project and supports all phases of the development cycle, including development, testing, build versioning, and deployment. Angular Material contains components for developing a graphical user interface for Angular. Angular Material consists of a set of components that implement common patterns of user interaction according to the Material Design specification. It consists of the common graphical user interface elements such as menu, button, table,



data entry forms, etc. Figure 3 shows a print screen of the user interface to access and manipulate alphanumeric cadastral data about rights and right holder stored in a cadastral database.

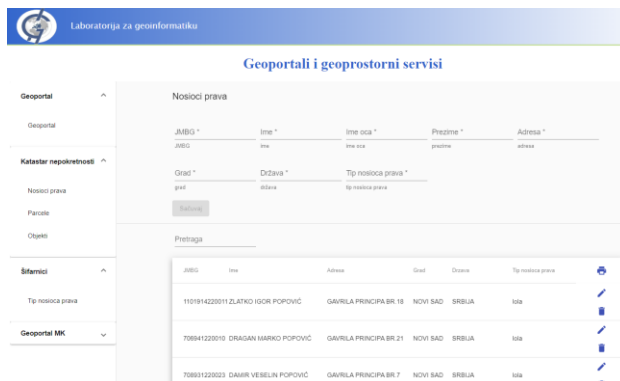

Figure 4. Alphanumeric cadastral data

Geoportali is realized using OpenLayers an open-source JavaScript library for working with geospatial data. It uses Geoserver as a backend to retrieve and display data in OGC WMS, WFS and WCS format. OpenLayers can display raster maps, vector data and markers loaded from any source. It was developed with the aim of promoting the use of geospatial information of all kinds. Using *npm install ol* command, OpenLayers library can be easily installed and integrated in the project. It is also necessary to install (*npm install proj4*) Proj4js JavaScript library [19] that supports all the coordinate systems and projections including coordinate system and projection for Serbia (EPSG: 32634 - WGS 84 / UTM zone 34N - Serbia). Figure 5 shows cadastral map data on the developed geoportali as part of A4GEO web application.



Figure 5. Geospatial vector data (cadastral map)

#### IV. CONCLUSION

The paper described the basic theoretical concepts and practical work related to the field of

SDI and geoportals and geospatial services that is used in education. The experience gained through the years of implementation of this curriculum showed the good results in increasing awareness of geospatial data sharing and technologies that enable this. Although, experts and students in the field of geodesy and geoinformatics are not familiar and prone to programming and informatics in general, acceptance of the newly gained knowledge and skills showed excellent results not only in studies, but in further professional career, too.

#### REFERENCES

- [1] Erl, T., 2005. Service-Oriented Architecture: Concepts, Technology, and Design. Prentice Hall, New Jersey, USA. 760 pages.
- [2] Richardson, L., Ruby, S., 2007. RESTful Web Services. Sebastopol, California: O'Reilly Media. ISBN 978-0-596-52926-0.
- [3] OpenGIS Consortium, <http://www.opengeospatial.org/> (accessed on 20 October, 2021).
- [4] Erl, T., Carlyle, B., Pautasso, C., Balasubramanian, R., 2012. SOA with REST: Principles, Patterns & Constraints for Building Enterprise Solutions with REST. Upper Saddle River, New Jersey: Prentice Hall.
- [5] Web Services Description Language (WSDL) 1.1, <https://www.w3.org/TR/wsdl.html> (accessed on 20 October, 2021).
- [6] Lange, K., 2016. The Little Book on REST Services. Copenhagen. p. 19.
- [7] Govedarica, M., Sladić, D., Radulović, A., 2018. Infrastruktura geoprostornih podataka i geoportali, Univerzitet u Novom Sadu Fakultet tehničkih nauka, Novi Sad, ISBN: 978-86-6022-125-6
- [8] Nebert, D., 2004. Developing Spatial Data Infrastructures: The SDI Cookbook, available at: [http://gsdiassociation.org/images/publications/cookbooks/SDI\\_Cookbook\\_GSDI\\_2004\\_ver2.pdf](http://gsdiassociation.org/images/publications/cookbooks/SDI_Cookbook_GSDI_2004_ver2.pdf) (accessed on 20 October, 2021).
- [9] Govedarica, M., Bošković, D., Petrovački, D., Ninkov, T. i Ristić, A., 2010. Metadata Catalogues in Spatial Information Systems. Geodetski list, 64 (87) (4), 313-334.
- [10] Vretanos, P., 2014. Web Feature Service 2.0 (WFS) Interface standard. Version 2.0.2 OGC 09-025r2. Open Geospatial Consortium, Inc. 254 pages.
- [11] International Standard, 2018. Web Coverage Service (WCS) 2.1 Interface Standard – Core, Version 2.0.1. OGC 17-089r1. Open Geospatial Consortium, Inc. 53 pages.
- [12] de la Beaujardiere, J., 2006. Web Map Server (WMS) Implementation Specification. Version 1.3.0. OGC 06-042. Open Geospatial Consortium, Inc. 85 pages.
- [13] INSPIRE, <http://inspire.jrc.ec.europa.eu/> (accessed on 20 October, 2021).
- [14] NIGP, <https://geosrbija.rs/> (accessed on 20 October, 2021).
- [15] Geoinformatika, <http://geoinformatika.uns.ac.rs/> (accessed on 20 October, 2021).
- [16] Geoserver, <http://geoserver.org/> (accessed on 20 October, 2021).
- [17] Spring, <https://spring.io/> (accessed on 20 October, 2021).
- [18] Angular, <https://angular.io/> (accessed on 20 October, 2021).
- [19] Proj4js <http://proj4js.org/> - projection library (accessed on 20 October, 2021).

***SCIENTIFIC  
PAPERS***

# Social Aspects of Distance Learning During the Covid-19 Pandemic

Ž. Namestovski\*, A. Buda \*\*, G. Molnár \*\*\*, Z. Szűts \*\*\*

\* University of Novi Sad, Hungarian Language Teacher Training Faculty Subotica, Serbia

\*\* University of Debrecen, Faculty of Arts Institute of Education and Cultural Management, Hungary

\*\*\* Department of Technical Education Budapest University of Technology and Economics  
Budapest, Hungary

VR Learning Center, Széchenyi István University, Győr, Hungary

\*\*\*\* Eszterházy Károly Catholic University, Faculty of Pedagogy, Eger, Hungary

zsolt.namesztovszki@magister.uns.ac.rs, buda.andras@arts.unideb.hu, molnar.gyorgy@gtk.bme.hu,  
szuts.zoltan@uni-eszterhazy.hu

**Abstract - In the analysis of the results of distance learning programs, which arose from the Covid-19 pandemic, we paid much attention to the technical and methodological aspects, but little heed was given to the social and societal elements. This study explores these aspects through some distinct examples and country-specific experiences in light of international reports and research results. It also addresses indicators such as access to the appropriate devices and the Internet, as well as other social aspects related to distance learning.**

## I. INTRODUCTION

The constantly evolving products and solutions of digital technology cause many problems and often provoke debates in society, but their presence in the educational process is almost unquestioned today. Indeed, for young people growing up in the 21st century, ICT and the Internet are now clearly part of the education system, and most institutions (notably in the higher education sphere) are unimaginable without digital technology (Buda & Czémán, 2021).

The coronavirus pandemic has resulted in a new social and, at the same time, new educational situation in the countries of the region, which has been resolved in various ways. Traditional contact-based education has been discontinued and was replaced by online instruction. Also common is that numerous digital curricula have been produced during this period, and significant databases have become available. In addition, many online platforms (such as a significant number of test builders) have made their previously premium services available free of charge.

As a result of the Covid-19 pandemic, social conditions around the world have changed radically in a short time. In addition to social conditions, education was significantly affected by this global pandemic. A large number of educational

institutions closed down, and the only option for continuing education became emergency remote teaching - ERT (Bozkurt & Sharma, 2020; Hodges, et al. 2020). According to visualized UNESCO (<https://en.unesco.org/covid19/educationresponse>) reports, April 2nd saw one of the highest amounts of school closures, when 84.8% of the total enrolled learners' institutions had been closed either partially or completely. At this time, this process affected 1,484,712,787 learners and led to 172 countrywide closures in 210 countries. In this situation, due to the circumstances, the transition to distance learning was not a result of pedagogical innovation, but rather an emergency response. Nonetheless, some institutions have handled the situation successfully, and in many cases, even created a more efficient, interactive and learner-centered educational environment. In several instances, however, these emergency solutions were not based on well-thought-out strategies. Our view is that the teacher's system, along with that of the effectiveness of the tasks sent via e-mail doesn't fall short of the expected efficiency and interactivity (Molnár, et al., 2000).

Internet service providers were not prepared for the sudden surge in demand, and people living in smaller settlements could experience the disadvantages of the insufficient penetration. The communication platforms (e.g. Zoom, Skype, Webex, Moodle, GoToMeeting, BlueJeans) were not always able to respond immediately to the demand, which complicated online education even further. The electricity consumption of the population has also increased, and in some countries it was not always possible to ensure a stable power supply. Therefore, power cuts caused a lot of inconvenience both for students and teachers (Oyedotun, 2020).

As an online survey of 59 countries reflects, almost all (87 percent) of education systems reported that unequal ICT access at home was a problem when introducing emergency remote education – ERE (Bond, 2020; Manca, et al., 2021). In addition, inadequate internet infrastructure (for 62 per cent) and electricity infrastructure (for 28 per cent) was also a problem (United Nations, 2020a).

## II. SOCIAL ASPECTS OF EMERGENCY REMOTE EDUCATION DURING THE COVID-19 PANDEMIC

While the methodological and technological solutions related to instruction during the pandemic have been subject to several research efforts, a smaller emphasis was placed on the respective impact on micro-communities of educational institutions along with the given socialization process.

Opportunities for students from lower-income or rural households were most often affected, but there were also significant differences between countries and regions. While less than 15 per cent of students in Western Europe and North America had no internet access at the time of the study, the proportion was as high as 80 per cent in sub-Saharan Africa. This lack of access precluded the students concerned from online distance learning (Giannini, 2020; UNESCO, 2020; UNICEF, World Bank, 2020).

Large numbers of students were deprived of the opportunity for directed learning along with being excluded from a part or a full spectrum of their regular social context. The elimination of interaction with teachers along with direct communication with peers were considered among the greatest losses (Espino-Díaz, et al. 2020; Ferri, et al. 2020).

Since face to face meetings in the physical space were cancelled the resulting lack of personal contact with fellow learners and instructors precluded any opportunity to gain shared experiences. Thus existing social connections could not develop while very few new contacts were established. This is especially true for those who started their studies during the implementation of emergency remote teaching programs. Such students could hardly or not at all enjoy the feeling of attending an educational institution, and were not able to learn the respective written or unwritten rules, or become familiar with the given traditions. Consequently, a sense of belonging to a community was not developed either.

Furthermore, another group was significantly impacted by the lockdowns. Accordingly, institution closures compelled students just starting independent living away from their families

according to their own pace to return to the home of their parents. Reintegration into the original family context, the loss of independence gained during participation in traditional face to face instruction coupled with the restricted personal freedom meant added difficulty.

In addition to the obstacles to children's socialisation in their peer group, the lack of a school's childcare function was a problem for many, as there was also the need to care for children who remained at home. This meant not only childcare but also the provision of meals; the closure of schools meant the loss of school meals. In the first months of the epidemic, 370 million children in 195 countries were affected, while hunger and malnutrition among the most disadvantaged increased (United Nations, 2020b). After the first shocks school meal programs were reorganized in several countries, but governments experimented with the introduction of meal vouchers and food packages as well. Furthermore, financial assistance was introduced in certain countries (Bárcena, 2020). From the students' point of view this approach has proven to be the least effective as in such cases there were no guarantees that the funds were used according to the original intent. Occasionally, despite the goodwill and helpful intentions, the given problem was made worse as impassioned disputes about the use of the monies increased intra-familial tension. Long term lockdowns, social isolation, restriction of cultural and recreational activities, the financial and professional uncertainty experienced by the parents along with the concern of older students for the health and wellbeing of themselves and their loved ones, or worries about the potential loss of a family member or friend were significant sources of stress. The inability to cope with the resulting tension exposed children to physical, emotional, or sexual abuse in addition to being victimized by domestic violence. The implementation of curfews and functioning difficulties of the warning mechanism built in the child protection system further deepened the crisis. Moreover, due to the lack of personal contact, the warning signs could not be recognized in the greater vicinity of potential victims.

## III. CONCLUSIONS

The availability of direct experience notwithstanding, the impact of the remote teaching programs implemented in response to the pandemic cannot be fully assessed. One of the main conclusions is that regardless of the return to the regular face to face teaching schedule certain students are reluctant to resume learning within traditional contexts. The potential causes include reluctance toward any social contact on the part of

parents or children excessively concerned about contracting the disease and many students, especially those whose prolonged stay at home led to significant weight gain, are afraid of being victimized by bullying or harassment by their peers again. A high number of students are concerned about academic failure due to the educational lag developed as a result of the lockdown and the fear of their inability to make up for the given losses.

Several research results confirm the formation of the learning gap during the implementation of remote teaching programs. Engzell and colleagues have investigated changes in the knowledge levels of Dutch primary school pupils during emergency remote education (Engzell et al., 2020). The national examination results of about 350,000 Dutch students in mathematics, spelling and reading comprehension in the first half of 2020 were compared with the examination results of the three years prior to 2020. They found that students acquired around 3 percentage points less knowledge during the first pandemic wave than they did in the same period in previous years. This is equivalent to about one fifth of a school years' worth of knowledge, meaning that students made little or no progress with the curriculum during the period of absence. It was also shown that the negative impact was not uniform across pupils; the fallback could be up to 55% higher for children of parents with lower levels of education than for children of more educated parents (Buda & Czékman, 2021). The discrepancy mainly results from the differing ability of families to compensate for the cessation of school or the loss of direct instruction. Having studied the extent of support provided to Spanish students of lower secondary level schools by their families Bonal and González identified significant differences related to the educational background of the parents. Families with lower qualifications or educational level had fewer resources and lesser knowledge to help their children in completing their school assignments as compared to the greater level of assistance given by their more educated counterparts. (Bonal & González 2020).

Other research results (Hammerstein, et al. 2021; Kuhfeld, et al. 2020) further confirm the negative impact of the knowledge gap emerging as a result of online or remote instruction while quantifying the respective influence on the economy as well. According to an OECD report issued in September 2020 the academic loss or learning gap related to the implementation of remote learning programs is irreversible and its economic impact implies that students experiencing the lockdowns can expect a 3% decrease of their overall income during their lifespan. (Hanushek – Woessmann 2020).

Consequently, the implementation of remedial programs or schemes aimed at eliminating the respective academic gap and preventing dropping out, especially for marginalized groups, is vital. Since learning programs utilizing digital solutions are expected to gain increasing prevalence in the future the educational environment of disadvantaged families should be improved both by providing appropriate infrastructure and devices along with educational support materials and instruction manuals (United Nations 2020a). Such methods and solutions should be developed, which enable students not only to acquire knowledge effectively, but to maintain intensive contact with peers and teachers while improving their social presence. Potential solutions include interactivity and cooperation based teaching and learning methods, such as differentiated group work, experience-oriented teaching, and gamification-based content i.e. digital escape rooms (Molnár-Orosz, 2021). These technologies and the wide scale utilization of the given methodological options provide the direction for the development of remote learning schemes in the future.

## REFERENCES

- [1] Bárcena, Alicia (2020). The social challenge in times of COVID-19, Economic Commission for Latin America (ECLAC), [https://repositorio.cepal.org/bitstream/handle/11362/45544/1/S200324\\_en.pdf](https://repositorio.cepal.org/bitstream/handle/11362/45544/1/S200324_en.pdf). (16.12.2021.)
- [2] Bonal, X. & González, S. (2020). 'The impact of lockdown on the learning gap: family and school divisions in times of crisis. *International Review of Education*, 66(5–6). 635–655.
- [3] Bond, M. (2020). Schools and emergency remote education during the COVID-19 pandemic: A living rapid systematic review. *Asian Journal of Distance Education*, (15)2, 191–247.
- [4] Buda, A., Czékman, B. (2021). Pandemic and Education. *Central European Journal of Educational Research*, (3)3, 1–10. <https://doi.org/10.37441/cejer/2021/3/3/10391> (10.12.2021.)
- [5] Bozkurt, A. – Sharma, R. C. (2020). Emergency remote teaching in a time of global crisis due to CoronaVirus pandemic. *Asian Journal of Distance Education*, 15(1), i–vi. <http://asianjde.org/ojs/index.php/AsianJDE/article/view/447> (15.07.2021.)
- [6] Engzell, Per & Frey, Arun & Verhagen, Mark D., (2020). Learning Inequality During the Covid-19 Pandemic, Center for Open Science. <https://ideas.repec.org/p/osf/socarx/ve4z7.html>
- [7] Espino-Díaz, L. & Fernandez-Caminero G. & Hernandez-Lloret, C. & Gonzalez-Gonzalez, H. & Alvarez-Castillo, J. (2020). Analyzing the Impact of COVID-19 on Education Professionals. Toward a Paradigm Shift: ICT and Neuroeducation as a Binomial of Action. *Sustainability*, 12(14), 5646. <https://www.mdpi.com/2071-1050/12/14/5646> (04.04.2021.)
- [8] Ferri, F. & Grifoni, P. & Guzzo, T. (2020). Online Learning and Emergency Remote Teaching: Opportunities and Challenges in Emergency Situations. *Societies*, 10(4), 86; <https://doi.org/10.3390/soc10040086> (30.10.2021.)
- [9] Giannini, S. (2020). Distance learning denied. *World Education Blog*. <https://gemreportunesco.wordpress.com/2020/05/15/distance-learning-denied>
- [10] Hammerstein, S., & König, C., & Dreisoerner, T., & Frey, A. (2021). Effects of COVID-19-Related School Closures on Student Achievement – A Systematic Review. <https://doi.org/10.3389/fpsyg.2021.746289> (17.08.2021.)

- [11] Hanushek, E. A., & Woessmann, L. (2020). The Economic Impacts of Learning Losses. OECD Education Working Paper (225). Paris: OECD Publishing. <https://www.oecd.org/education/The-economic-impacts-of-coronavirus-covid-19-learning-losses.pdf> (14.08.2021.)
- [12] Hodges, C. – Moore, S. – Lockee, B. – Trust, T. – Bond, A. (2020). The Difference Between Emergency Remote Teaching and Online Learning. Educase Review. <https://er.educause.edu/articles/2020/3/the-difference-between-emergency-remote-teaching-and-online-learning> (02.04.2021.)
- [13] Manca, S., Persico, D., & Raffaghelli, J. E. (2021). Editorial. Emergency Remote Education: Methodological, technological, organizational and policy issues. Italian Journal of Educational Technology, 29(2), 3-9. <https://doi.org/10.17471/2499-4324/1251> (25.09.2021.)
- [14] Molnár Gy., Námesztovszki Zs., Szűts Z. (2020). Switching to online education, experiences from Hungary and Serbia, XI International IT and education development conference 2020, Technical Faculty “Mihajlo Pupin”, University of Novi Sad, Zrenjanin, 978-86-7672-341-6, 55-59.
- [15] Molnár Gy, Orosz, B. (2021). A digitális átállás innovációs lehetőségei és kezdeti tapasztalatai, (Innovation options and initial experiences of digital transformation) In: Juhász, Erika; Kozma, Tamás; Tóth, Péter (szerk.) Társadalmi innováció és tanulás a digitális korban (Social innovation and learning in the digital age), Debreceni Egyetemi Kiadó, Magyar Nevelés- és Oktatáskutatók E(gyesülete) (HERA) pp. 268-279.
- [16] Oyedotun, T. D. (2020). Sudden change of pedagogy in education driven by COVID-19: Perspectives and evaluation from a developing country. Research in Globalization, Volume 2, December 2020, <https://doi.org/10.1016/j.resglo.2020.100029> (03.04.2021.)
- [17] UNESCO, UNICEF and the World Bank (2020 October). What have we learnt? Overview of findings from a survey of ministries of education on national responses to COVID-19. Paris, New York, Washington D.C.: UNESCO, UNICEF, World Bank. <https://data.unicef.org/resources/national-education-responses-to-covid19/>
- [18] United Nations (2020a). National Education Responses to COVID-19 Summary report of UNESCO’s online survey.
- [19] United Nations (2020b). Policy Brief: Education during COVID-19 and beyond. [https://www.un.org/development/desa/dspd/wp-content/uploads/sites/22/2020/08/sg\\_policy\\_brief\\_covid-19\\_and\\_education\\_august\\_2020.pdf](https://www.un.org/development/desa/dspd/wp-content/uploads/sites/22/2020/08/sg_policy_brief_covid-19_and_education_august_2020.pdf)

# Covid 19 and Online Learning Platforms

M. Gaborov\*, D. Karuović\*, M. Kavalić\*\*, D. Milosavljev\*, S. Stanisavljev\*, J. Bushvati\*\*\*

\*University of Novi Sad, Technical faculty "Mihajlo Pupin" Zrenjanin, Serbia

\*\* University of Novi Sad, Faculty of Technical Science, Novi Sad, Serbia

\*\*\*University of Shkodra "Luigj Gurakuqi" , Albania

majagaborov26@gmail.com

**Abstract** - The emphasis of this paper is on the perception of teaching during the Covid 19 pandemic. The subject of the research was presented through the definition of the most adequate type of teaching online. The research was conducted in the period when the virus - covid 19 first appeared (2020). The sample consisted of students from the Technical Faculty in Zrenjanin (N = 83). The results of the research showed the extent to which students believe that online learning is represented in the Republic of Serbia, as well as which software is most used.

## I. INTRODUCTION

The motivation for this work was the sudden pandemic that is present in the Republic of Serbia. The term "e-learning" is one of the most widely used syntax processes today in modern education around the world. Various definitions of e-learning are used. E-learning is a methodology by which "teaching content or learning activities are delivered using electronic technologies"[1]. E-learning involves the application of different forms of information and communication technologies in the education component in order to improve the quality of learning [2]. The role of blended and online learning, including 'flipped learning' as well as the use of various learning management systems or 'platforms' in tertiary education is the subject of much examination amongst scholars. There is growing interest in the way that online or cloud-based tools, and pedagogy implemented to support such tools, might generate greater participation and interaction between students, and between students and their teachers in tertiary education [3].

This paper's structure consists of several sections. The Research methodology section explains the research problem, research goal, research questions, hypothesis, place and method of research and sample. The next section is something about online learning platforms. The results of research are presented in next section. The Final sections are discussion and conclusions.

## II. THEORETICAL BACKGROUND

E-learning is a modern method of teaching and learning in academic and other institutions that takes

place with the help of information and communication technologies (ICT) where the learner is at the center [6].

"Higher distance education offers a scenario for the development of teaching-learning processes through educational platforms and their functionalities for didactic communication, mainly online forum [4]. "The learning platform is a way of structuring the instruction that fosters optimal organization of content and interaction with students, and it is used by most of the Universities. Teaching must take advantage of virtual environments and adapting the discourse to the uniqueness of the virtual environments complexity. Learning platforms have been presented as virtual scenarios that promote educational innovation and professional development, more focused on the model of educational personalization, with emphasis on cooperation. [4]. The key elements of a new technological education platform are: a massive open online course (MOOC); learning management systems (LMS); the ecosystem of support for a new education; a new education infrastructure [5]. The utilization of technology improves the quality degree of learning and teaching. One of the most used e-learning platforms is Google Classroom. Google Classroom is developed by Google for academic purposes that support a blended learning platform. This application is so simple to use, does not take too many spaces on the smartphone's memory and help teacher and student keep on the lesson's track. Google Classroom allows teachers to spend more time with their students and less time on the paperwork, and it is now even better. Google's latest announcement brings new functionality to Google Classroom. Included in the new functionality is the ability to add more than one teacher, as well as to preparing for classes in advance as well [7]. Technology has facilitated language learning by introducing platforms for educational purposes. These platforms are also known as Online Management Learning Systems (OMLS) or Course Management Systems (CMS). These systems allow students to connect in groups or individually. These platforms help the students to get access to lectures through handouts or

videos. These platforms can help teachers to publish activities and tests for their students and assess them. Some of these platforms are commercial like Blackboard, and others are free and provide open-access for both the teacher and his group like Moodle [8]. Moodle is a free learning management system that enables you to create powerful, flexible, and engaging online learning experiences. Moodle is designed to support a style of learning called Social Constructionist Pedagogy. This style of learning is interactive. The difference between a traditional class and the social constructionist philosophy is the difference between a lecture and a discussion. Moodle enables to add six types of interactive course material. This is course material that a student interacts with, by answering questions, entering text, or uploading files:

- Assignment (uploading files to be reviewed by the teacher and/or students)
- Choice (a single question)
- Journal (an online journal)
- Lesson (a conditional, branching activity)
- Quiz (an online test)
- Survey (with results available to the teacher and/or students) [9]

Moodle also offers five kinds of activities where students interact with each other. These are used to create social course material:

- Chat (live online chat between students)
- Forum (you can choose the number of online bulletin boards for each course)
- Glossary (students and/or teachers can contribute terms to site-wide glossaries) [9].

Figure 1. shows how the respondents answered the question “How online learning can improve teaching?”. The answers were as follows: student group work on joint projects (26), by hiring professors to pay attention to the work and progress of students (41), by providing additional activities to students in accordance with their interest (35), using digital tools for interactive teaching and online learning (32). [10]

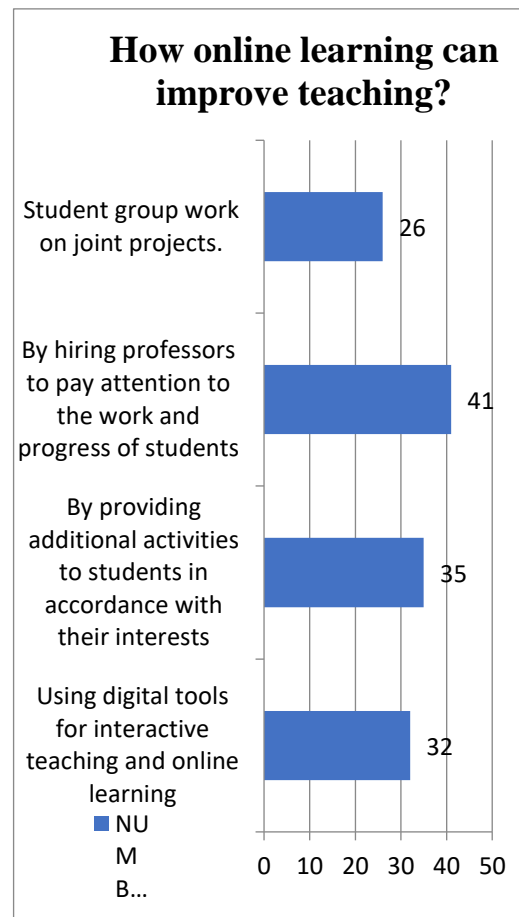

Figure 1. How online learning can improve teaching [10]

### III. RESEARCH METHODOLOGY

Research is conducted upon the methodology presented as follows:

1. Research goal- The goal is to determine which online learning platforms the student uses during online teaching.

2. Research questions:

RQ1: Which online learning platforms did you use during online classes?

3. Hypothesis:

Respondents claim that it is best to use Google classroom when teaching online.

4. Place and method of research – The research was conducted at the Technical Faculty at Zrenjanin by dividing the survey through social networks.

5. Sample –The survey was conducted in the period from 20.04.2020 to 26.04.2020 where the respondents were 83 students from the Technical Faculty in Zrenjanin.



#### IV. EMPIRICAL RESEARCH RESULTS AND DISCUSSION

Table 1 shows a sample of students by age.

TABLE I. Years of students on scale

Years on scale	19-25	26-30
Number of students	79	4

The survey was completed by 79 respondents studying at the faculty in Zrenjanin. Most are aged 19-25.

Table 2 shows the year of study of the respondents.

TABLE II. Years of study

Years of study	First	Second	Third	Fifth
Number of students	39	13	12	12

A small number are older than 26. The respondents were from all years. In the first year there were 39 respondents, in the second 13, in the third 12, in the fourth seven and in the master 12 students.

Table 3 shows the area of study.

TABLE 3. Department

Department	IT	Mechanical engineering	Management Engineering	Oil and Gas	Clothing engineering	Environmental engineering
Number of students	48	6	5	12	7	

The students were from several fields: IT (48), mechanical engineering (6), oil and gas (12), clothing engineering (7), environmental engineering (5) and Management Engineering (5).

Picture 2 shows the online learning platforms that students use.

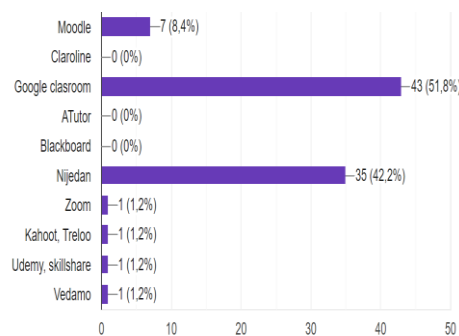

Figure 2. Online learning platforms

To the question of which online platforms students use, there were different answers: Google classroom (43), Moodle (7), Zoom (1), Kahoot (1),

Udemmy (1), others (35) said that they use none. Suffice it to conclude that students used a small number of online learning platforms.

The survey was completed by 79 respondents studying at the faculty in Zrenjanin. Most are aged 19-25. A small number are older than 26. The respondents were from all years. In the first year there were 39 respondents, in the second 13, in the third 12, in the fourth seven and in the master 12 students. The students were from several fields: IT (48), mechanical engineering (6), oil and gas (12), clothing engineering (7), environmental engineering (5) and Management Engineering (5). To the question of which online learning platforms students use, there were different answers: Google classroom (43), Moodle (7), Zoom (1), Kahoot (1), Udemmy (1), others (35) said that they use none. Suffice it to conclude that students used a small number of platforms.

#### V. CONCLUSION

Online learning as one of the forms of e-education, is full and massive in Serbia received practical application during the COVID 19 pandemic. In e-learning, students can determine the pace, place and time of learning, which is also a significant advantage of this type of education. This kind of learning is significant cheaper than classical teaching, the quality of education is at a higher level, time the savings are great, and a large number of students can be educated in a short time. The results of the research show that Google classroom is mostly representative software for online teaching. On the basis of which we can say that the hypothesis was confirmed. It would be necessary to investigate whether professors manage during online classes and to see which platform they like to use for teaching, etc.

#### REFERENCES

- [1]. Prof drGlušac D., Elektronskoučenje, Zrenjanin 2012.
- [2]. Mikša M., Hercigonja – Szekeres M., Sikirica N., Students attitudes about e – learning, Zagreb 2015.
- [3]. Heggart K. R., Yoo J., Getting the most from google classroom:a pedagogical framework for tertiary educators, AustraliranJournal of Teacher Education, Volume 43, Issue 3, 2018.
- [4]. <https://ro.ecu.edu.au/cgi/viewcontent.cgi?referer=https://scholar.google.com/&httpsredir=1&article=3792&context=ajte>
- [5]. <https://dergipark.org.tr/en/download/article-file/641836>
- [6]. <https://www.iejme.com/download/technological-platform-for-realization-of-students-individual-educational-trajectories-in-a.pdf>
- [7]. [http://darhiv.ffzg.unizg.hr/id/eprint/9753/1/Muzina\\_Diplomski%20.pdf](http://darhiv.ffzg.unizg.hr/id/eprint/9753/1/Muzina_Diplomski%20.pdf)
- [8]. <http://repository.uin-malang.ac.id/7513/1/7513.pdf>
- [9]. <https://files.eric.ed.gov/fulltext/EJ1269343.pdf>
- [10]. [http://ead.iesgo.com.br/pluginfile.php/883/mod\\_resource/content/0/apostilas/Moodle\\_Sample\\_e-book.pdf](http://ead.iesgo.com.br/pluginfile.php/883/mod_resource/content/0/apostilas/Moodle_Sample_e-book.pdf)
- [11]. Gaborov M., Karuović D., Jerković N., Đordan N., FelbA.: Analysis of students attitudes on e – learning, ITRO 2020–IXInternational Symposium Information Technology and Development of Education, Zrenjanin, Srbija, 2020. , ISBN 978-86-7672-341-6.pg.151-

# Distance learning from the perspective of students during the COVID-19 pandemic

M. Majstorović, D. Radosav

Univerzitet u Novom Sadu, Tehnički fakultet „Mihajlo Pupin“, Zrenjanin, Republic of Serbia  
milana.majstorovic@tfzr.rs dragica.radosav@tfzr.rs

**Abstract** – A pandemic COVID-19 virus has been declared in Serbia due to which it was necessary to suspend temporarily direct educational work in primary and secondary schools because of the epidemiological situation. Government of the Republic of Serbia has temporarily suspended the immediate teaching in higher classes in schools, which doesn't mean that the educational work with students has been also suspended. The Educational work has been continued in schools for the students from the first to the fourth grade in elementary schools, while it has been continued through distance learning with the older classes. In addition to numerous definitions which describe the distance learning, it can most simply be defined as a process of exchange of data and information between the students and their professor via the Internet realizing the educational work. The aim of this paper is to bring the concept of distance learning closer and to explain its significance and the platforms through which it can be realized. Considering the selected subject research within the set thesis, the main empirical goal of the research is to show how much distance learning has managed to replace a traditional school teaching, according to the students' opinion. In other words, the goal is to establish to what extent the students were able to adjust to the teaching of distance. Also, one of the goals is to determine whether distance learning negatively affects social development of students as well as how much time it takes. The surveying technique monitored by the appropriate instrument (anonymous questionnaire) was used to collect data. The survey was made with the help of Google questionnaire and was sent to high school students.

## I. INTRODUCTION

The notion of so-called "distance learning", in today's time is associated with the concept of learning via the Internet, i.e. by e-learning. Every day new information are created, and the general development continuously requires new knowledge and skills. There is a need for the faster, timely education, which will be open, wide available at the same time. Thanks to the Internet, learning is no longer confined to the four walls of the classroom and is available to anyone at any time of the day" [1] "through continuous testing, knowledge verification at all levels, then electronic communication with professors and others course participants, use of ICT (information and communication technologies) for learning purposes. In short, approaching and connecting the Internet and learning, in other words - Internet-enabled

learning. "Serbia is meeting for the first time with distance learning when it comes to regular schooling. Although she was not ready for this form of teaching, online platforms that are easy to use as for professors as well as for students, have helped a lot. Some of these platforms are Microsoft Teams, Google Classroom, Viber, Zoom and many others that have been used for interaction and material exchange.

"The distance learning does not mean physical student and teacher's presence. They are spatially and temporally distant from each other, but using modern technology this distance is overcome. This kind of learning is enabled at all education levels- from elementary school, high school and college to adult education. The reasons for distance learning are different - a great distance from school or college, illness. At the beginning of the distance learning the student should meet his/her teacher to make their communication easier and the student will be explained how it works at the same time. Both participants in the process must have a good equipment to make a distance learning functional. That means a good computer, internet that is in constant function and, of course, a lot of patience." [2]

## II. THEORY AND HYPOTHESES

"A distance learning is actually a very old concept. The first successful attempts were in the middle of the nineteenth century when the students, who from some reasons had been prevented to physically attend classes, received learning materials by mail once a week. Universities accepted this model of learning very quickly and in just a couple of decades diplomas from famous universities became more accessible than ever, even to those who had no money for classical studies. However, the real renaissance a distance learning experienced with the advent of the internet." [3] An important segment for the realization of teaching is monitoring and evaluation of teaching and learning, student achievements and own practice, especially in these changed circumstances, because, for example, even the most experienced teachers

sometimes won't be able to predict what the effects of giving an application of a particular method or planning student activities would be like if class lasts less than 45 minutes or if teaching takes place online. Therefore, it is necessary to monitor the effects of the planned methods, activities, learning materials and etc. during each class, and after each class to reconsider whether something could have been done in others way, whether the goal has been achieved, whether the students achieved planning outcomes, etc. Student's achievements need to be continuously monitored and students should be given the feedback and tips for further progress, because the new work organization greatly will influence both on them and their way of working and it depends on a teacher to a large degree how the students will adapt to new circumstances. [4]

Main hypothesis:

A distance learning cannot replace a traditional teaching in schools.

Auxiliary hypotheses:

- The students need more time for a distance learning than teaching in schools so they do not have enough left time for sports and other activities.
- A distance learning has a negative effect on a student social development.

### III. ONLINE PLATFORMS

Due to the impossibility of performing the traditional classes in schools because they are closed due to the COVID-19 pandemic, a distance learning with the help of digital platforms takes over a major role. Moving schools into the environment of a distance learning, Microsoft Teams can provide an online classroom that enables shared virtual, face to face connections, tasks, files, and conversations on a single platform available on a mobile device, tablet, computer or search engine. ” [5]

"Google Classroom is a free application or a type of a distance learning platform. Google classroom offers teachers the opportunity to create their own virtual (on-line) space, actually a classroom where they can communicate with students, share materials, links, ask those questions, tasks, but also evaluate their activity. ” [6]

Viber is a multi-platform application that students also use with their professors and head teachers for materials and information`s exchange.

Zoom platform is an online platform that is great for a video communication. It's not limited by the number of participants, but it is by the meeting time of 40 minutes.

"Edmodo is a distance learning platform. It provides access to teachers, students and parents.

Teachers can post messages, texts, different files, they can create tasks and tests as well as evaluate. They have a complete control over the work environment and manage it. Students have access to all teaching materials assigned to them by the teacher, but they can also set different types of content themselves. The parental account is linked to the student's account and every parent can track just a progress of his own child.” [7]

“Moodle is a unified set of tools which allows access to common sources of knowledge, the exchange of educational materials, as well as the use of additional modules which provide the expansion of functionality.” [8] "Moodle is an online platform for a distance learning, designed to enrich students' experience and knowledge giving them access to materials for learning, courses, activities, taking exams, tests, etc., all via the internet. Moodle is a platform designed to provide teachers, administrators and participants (students) a safe and integrated system for a creation of a personalized learning environment. The Moodle platform is proven to be a reliable tool and with over 90 million users all over the world on academic and corporate level and represents the most popular and most commonly used e-learning platform. ” [9]

Common to these platforms is:

- They are free to use;
- We can use them on our own computers and telephones;
- No settings;
- 4. An excellent video and audio quality. In Serbia the Ministry of Education created a portal for elementary and high schools where they placed recorded classes in accordance with the teaching plan and program and sorted them according to the areas of work and years of study by which students can access. The portal's address is: <https://www.mojaskola.gov.rs/>

The plan of The Ministry of Education is that schools can use those classes in the future in case of extraordinary circumstances as well as in regular circumstances if it is estimated that there is a need.

### IV. RESEARCH METHODOLOGY

An online survey technique which is accompanied by an appropriate instrument (an anonymous questionnaire) is used for data collection, so the research results would show the more realistic picture that exists in high schools in Serbia. The survey contains 21 questions that are divided into basic, general, teaching and social ones. Some of the

results of the questions are shown with the help of the graph.

1. We use a platform(s) to monitor a distance learning.

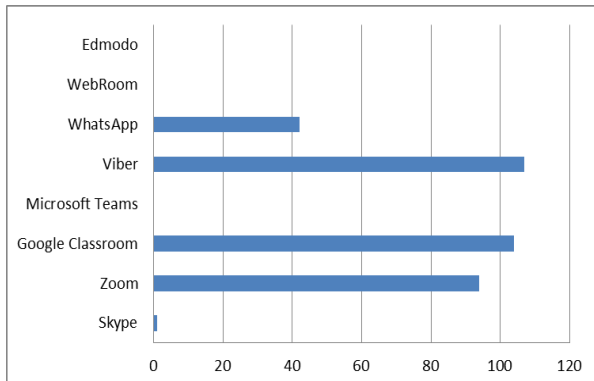

Figure 1. Platforms used by students to monitor a distance learning.

2. The place where I live has a completely developed 4G network and I have no problems with the Internet connection.

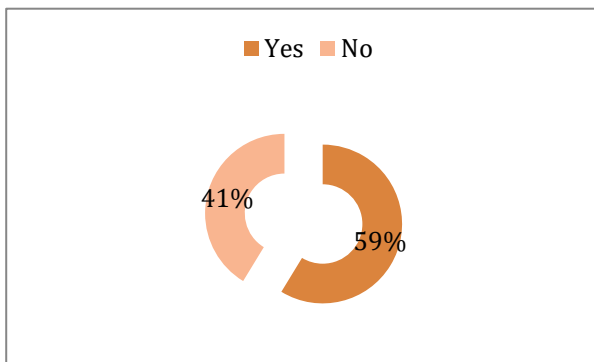

Figure 2. Students who have a completely developed 4G network in the place where they live.

3. I consider that a distance learning makes a social development difficult.

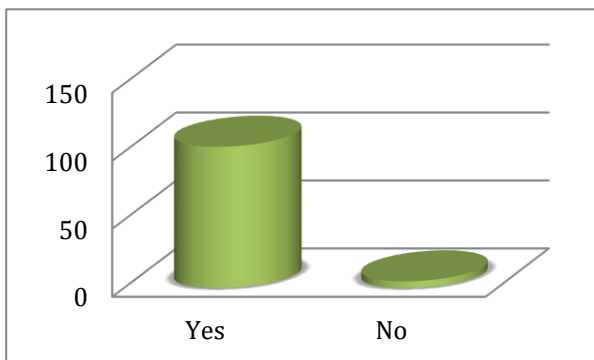

Figure 3. A social development

## V. DISCUSSION OF RESULTS

Although a distance learning is similar in other schools, the success of it depends both on the professor and students. It also depends on the

development of 4G networks in the place of residence of students. 41% of respondents do not have a fully developed 4G network and because of that they have both problems with the Internet connection and at monitoring a distance learning. 44% of the respondents failed to adjust at a distance learning for the entire duration of the same. 81% of respondents did not agree with the claim that during the distance learning teachers respect the duration of classes and rest, which is a problem if they have some other activities that are not related to teaching and 29% of respondents did not agree with the claim that professors in case of technical problems have understanding. 90% of respondents do not understand the material as they would understand in school by a traditional type of teaching. 62% of respondents have a neutral attitude about the success of a communication with the professor during the class, as well as about the claim that the professor tries to bring the material closer to them as he would do at school and that he is ready to listen to them if they have any objections. 85% of respondents by their subjective feeling consider that they did not acquire a sufficient knowledge by a distance learning for a new school year. By attending a distance learning classes the eyes are exposed to an excessive looking at the computer and / or mobile phone screen due to which the eyes become even more tired which can lead to the worsening of the vision which is not the case when we speak about the traditional type of teaching in schools. 71% of respondents notice some vision problems due to an excessive computer and mobile phone use. The results show that the main hypothesis set above in the paper is entirely confirmed, ie to teach students through a distance learning cannot replace a traditional type of teaching in school. 59% of respondents spend 5-8 hours a day learning and following a distance learning, while 9% of respondents even more than 8 hours, due of which 54% of respondents did not agree with the claim that they have sufficient time for extracurricular activities during the follow-up teaching at a distance learning and it shows that the given auxiliary hypothesis is also confirmed, which means that a distance learning takes more time from teaching in schools so the students don't have any left enough time for sports and others activities. The second hypothesis was also confirmed with 95% of respondents who agreed with the claim that a distance learning makes their social development difficult. The goal of teaching at distance is to reduce contacts due current epidemiological situations, but that badly affects the social development of students.

## VI. CONCLUSION

Based on the results of the survey, we have found out that many students do not have a completely developed 4G network, that they failed to adapt to a distance teaching duration and, as the most important, that a large number of students do not understand the material as they would understand in a traditional school teaching. It can't be said that the distance learning is bad, because it depends on many things: on the professor, on the student, but also on a technical equipment. According to the presented research about a teaching on distance from the perspective of high school students in Serbia we can conclude that a teaching on distance cannot replace a traditional teaching in schools, thus the hypothesis set in this work is fully confirmed. Students have gone to school for years using the traditional kind of teaching, so they were not ready to cross "overnight" to another kind of teaching, in this case to a distance learning. A mitigating circumstance is that every high school student is familiar with the technology and has his own mobile phone that can be used for following a distance learning. A distance learning cannot replace learning through an interaction "face to face", but it can be used as an addition to a traditional form of teaching. Statistical data processing in a conducted research were obtained data confirming the first auxiliary hypothesis, which means that a distance learning takes more time from teaching in schools so the students don't have any left enough time for sports and others activities. Also, the second auxiliary hypothesis is confirmed, which means that a distance learning negatively affects a social development of students.

## REFERENCES

- [1] [1] LEARNING THROUGH THE INTERNET-THOUGHTS AND ATTITUDES OF STUDENTS, G. Gabrilo, J. Rodek, 2019.
- [2] <https://www.semanticscholar.org/paper/U%C4%8CENJE-PUTEM-INTERNETA-MI%C5%A0LJENJA-I-STAVOVI-Gabrilo-Rodek/7fedd622ed83c121be11b584e15ff1de2becf16#paper-header>
- [3] [2] Distance learning - pros and cons, G. Stanojević,
- [4] 2020.
- [5] <https://www.institut.edu.rs/ucenje-na-daljiju-za-i-protiv/>
- [6] [3] PROJECT TEACHING MANUAL I DISTANCE TEACHING, Milan Petrović, Deniz Hoti, Olivera Todorović, 2020. <https://zuov.gov.rs/wp-content/uploads/2020/09/Prirucnik-za-nastavu-CIR.pdf>
- [7] [4] RULES ON THE SPECIAL EDUCATIONAL PROGRAM (& quot; Official GazetteRS&quot;, br. 110/2020)
- [8] <https://www.paragraf.rs/propisi/pravilnik-o-posebnom-programu-obrazovanja-i-vaspitanja.html>
- [9] [5] Microsoft Teams
- [10] <https://news.microsoft.com/en-cee/2020/03/21/efikasno-i-motivisano-ucenje-na-daljiju-sa-microsoft-resursima-za-edukaciju/>
- [11] [6] Google Classroom Access Guide, M. Milanov, 2020.
- [12] <https://zelenaucionica.com/wp-content/uploads/2020/03/Uputstvo-za-pristup-Guglu%C4%8Dionici-Google-Classroom.pdf>
- [13] [7] Edmodo platform
- [14] <https://new.edmodo.com/>
- [15] [8] Moodle platform for education, Vladimir Blagojevic, 2015.
- [16] <https://www.helloworld.rs/blog/Moodle-platforma-za-edukaciju/560>
- [17] [9] Moodle eLLab, Handbook for Lecturers, b.
- [18] Lalic, U. Marjanovic, I. Zunic, B. Bogojevic, 2017.
- [19] [http://ellab.ftn.uns.ac.rs/moodle/pluginfile.php/46008/mod\\_resource/content/1/Priru%C4%8Dnik%20za%20predava%C4%8De%20online%20verzija.pdf](http://ellab.ftn.uns.ac.rs/moodle/pluginfile.php/46008/mod_resource/content/1/Priru%C4%8Dnik%20za%20predava%C4%8De%20online%20verzija.pdf)

# Analysis of LMS Used in The Process of Distance Learning in Primary Education, During the COVID 19 Pandemic

A. Mamić\*, M. Blagojević\*, T. Đuričić\*\*

\* University of Kragujevac, Faculty of Technical Sciences, Čačak, Serbia

\*\*Primary school Petar Kočić, Inđija, Serbia

acomamic@gmail.com, marija.blagojevic@ftn.kg.ac.rs, tijanadjuricic86@gmail.com

**Abstract - The main goal of this paper is to analyze the use of different LMS during the implementation of distance learning in primary schools. For the needs of the research, a survey was conducted among primary school teachers. In the survey, in addition to the commitment to the platform they used, the teachers also evaluated it in accordance with the ISO / IEC 9126-4 standard, which defines the software quality metrics in use. The results showed that most teachers used the Google Classroom platform, whose characteristics of effectiveness, productivity, safety and satisfaction on a scale of 1 to 5 were rated high (average around 4). The general thesis in conclusion is that the expansion of the use of the Google classroom followed due to its simplicity and accessibility of the platform itself.**

## I. INTRODUCTION

The education system in the Republic of Serbia can be divided into 3 comprehensive units: primary, secondary and higher education. A common and essential factor of all three levels of education is the teaching process. This process takes place continuously, with minor interruptions, during most of the school year, with the exception of holidays in primary and secondary education, as well as exam deadlines in higher education. The teaching process is a key segment of education due to the fact that during its implementation, students are directly transferred knowledge by teachers and professors. In combination with various practical examples and tasks for the exercise, pupils and students acquire the necessary knowledge, skills and competencies, which over time build them into an independent and educational member of the social community.

During the teaching, teachers and professors use different forms and methods, at all levels of education. The method of classical, ie traditional teaching has been present for a long time and was considered the foundation of the educational process. The accelerated development of information and internet technologies has conditioned their influence in education, which has led to a modern approach to

the teaching process. First of all, new technologies have brought the possibility of faster flow and exchange of information, both in the teacher / professor - student / student relationship, and between students and students with each other. Also, many processes and phenomena that teachers and professors explained in an abstract way, can now be visually demonstrated using various animations and simulations. All these benefits have contributed to the fact that the timely approach to teaching has gained so much momentum, that some higher education institutions have accredited directions, where complete teaching is performed at a distance.

However, the professional public agrees that the most optimal model of teaching, the so-called. a hybrid model, which implies a combination of traditional and modern approach, because it is indisputable that despite technological development, the fundamental role of teachers as lecturers must not be surpassed.

Precisely on the hybrid principle, classes are mostly organized in schools and colleges across our country. Teachers in classrooms and classrooms teach the material, which is available to pupils and students through various platforms after the end of the lecture. Those from home can remember the lecture or if they missed an hour to see it for the first time. They use the same platforms to create and teach homework, seminar and project assignments, which completes the model of hybrid teaching as a whole.

However, in March 2020, due to the COVID19 virus pandemic, a state of emergency was declared in the Republic of Serbia. All types of public gatherings are prohibited and all public institutions are closed, except for health ones. Unfortunately, these measures meant the closure of all schools and faculties, after the expiration of a little more than

half of the current school year. In order for the school year not to end prematurely, and for pupils and students to be left without the constitutionally guaranteed right to education for an indefinite period, the Ministry of Education, Science and Technological Development made a decision that from March 17, 2020. until the end of the state of emergency, classes take place entirely at a distance [1].

The topic of this paper is an overview of the use of different LMS in primary schools, during the state of emergency and the epidemic of the COVID 19 virus in the Republic of Serbia. This paper is written in real time, by authors which were directly involved in the process of conducting distance learning, which gives it additional scientific value. After the introduction, a brief overview of the very concept of LMS is given. Chapter 3 presents the most commonly used systems during distance learning. Chapter 4 presents the research methodology used, while Chapter 5 provides a brief overview of related research. The obtained results are presented in the sixth, while in the last chapter a conclusion is represented.

## II. LEARNING MANAGEMENT SYSTEMS (LMS)

The Learning Management System is a software platform that provides a virtual and collaborative environment for the entire teaching process. It is characterized by simple setting of teaching materials and tests, monitoring of progress and efficient communication with students, proper storage of pedagogical documentation, etc.

The concept of a learning management system arose directly from e-learning. Although the first LMS appeared in the higher education sector, a large percentage of LMSs today are commercially oriented, ie manufacturers offer their systems to primary and secondary, public and private schools. Learning management systems make up the largest segment of the learning systems market.

Learning management systems are designed to identify learning deficiencies, using analytical data and reporting. LMSs are focused on providing online learning, but support a range of uses, acting as a platform for online content, including courses, asynchronous and synchronous. The LMS may offer instructor-led training classroom management or a diverted classroom, used in higher education. Modern LMSs include intelligent algorithms for making automated course recommendations based on user skills profiles, as well as for extracting

metadata from teaching materials to make such recommendations even more accurate [2].

The advantages of using an LMS are [3] [16]:

- Easy placement of materials in various formats (text, images, audio and video).
- Ability to correct, update and supplement material in real time.
- Access from anywhere at any time
- Pupils and students determine the pace of their work.
- Possibility of frequent evaluation
- Intensive communication

Some of the problems that occur when using LMS are [3]:

- Technical requirements (hardware, software, fast and constant internet connection)
- Great engagement of teachers (preparation of materials and tests, communication)
- Inability to control unethical student behavior during testing

## III. LMS USED IN PRIMARY EDUCATION

In the first week of the transition to distance learning, the Institute for the Advancement of Education and Upbringing published on its website a list of recommended platforms for distance learning. Some of the recommended platforms are: My School, Microsoft Teams, Edmodo, Google Classroom and Moodle. These platforms will be presented in more detail in the following subsections.

### A. *My school - a platform of the Ministry of Education*

The Ministry of Education, Science and Technological Development has launched the "My School" platform, as a direct support to the realization of distance learning. Tests and additional materials are available on this portal, which are directly related to the hours broadcast through the RTS communication channels. The platform is available at <https://www.mojaskola.gov.rs/>. For those who do not have internet access, free access is provided through all three national mobile operators.

The main feature of this LMS is that it is intended exclusively for primary and secondary school students, while teachers do not have the opportunity to work in their role. Elementary school students access the platform using already created

parameters, while high school students must create an account on their own. Also, parents of elementary school students can create accounts for their children and thus monitor their progress. The courses are divided into four categories:

- The first cycle of primary school
- Second cycle of primary school
- Gymnasium
- Secondary vocational school

The lessons are in video format, and after each one a short test is created with which the student can independently check what he has learned.

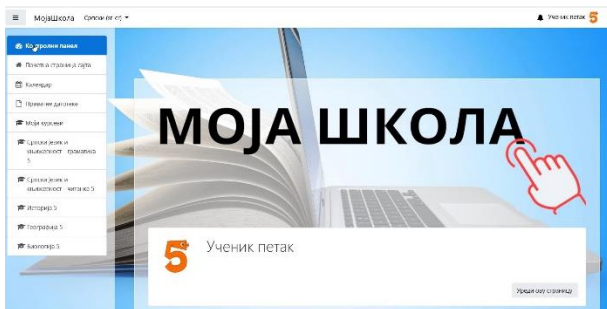

[4] Figure 1. Appearance of the My School platform interface

### B. Microsoft Teams

This application is part of a much broader Office 365 platform. MS Teams is fully customized for educational purposes. The application is free to use during the entire period of distance learning and can be accessed via the link <https://teams.microsoft.com/>. Teachers receive access parameters from school principals, and class teachers also receive data for students. When students log in to the system for the first time, they see Office 365 services, but when students first access Teams, permission is required to join Teams School, which must be approved by the class teacher.

The organization of work in the Teams program is done by creating teams: a team is automatically created for each class managed by the class teacher, and additionally teams are created for learning the subject (for subject teaching), a team that consists of a teachers' council, etc. It is possible to additionally create teams for student sections, etc. but for the sake of clarity it is advisable to agree on a rule for the appointment of these teams. For the communication of teachers, a team of the teachers 'council is created within the school "Teachers' council" to which all members of the team (teachers, administration, psychological and pedagogical

service) have been added. It is not advisable to create a large number of teams that are difficult to administer and monitor due to their large number, but only necessary for the functioning of teaching. The teacher who created the team chooses who to add to the team and administers it [5].

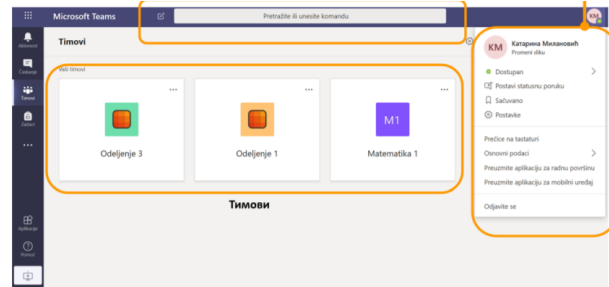

[5] Figure 2. Appearance of the MS Teams application interface

### C. Edmodo

Edmodo is a distance learning platform. It is accessible to teachers, students and parents. Teachers can post messages, texts, various files, create assignments and tests as well as grade. They completely control and manage the work environment. Students have access to all teaching materials assigned to them by the teacher, but they can also post different types of content themselves. A parental account is linked to a student account and each parent can only monitor the progress of their child. The access link can be found at <https://new.edmodo.com/>.

Edmodo does not require students to have their own email addresses and is therefore very suitable for working with lower grade students. Edmodo is a global social network dedicated to education, and work on it is free. Allows you to create classrooms and small groups, Post posts, create questionnaires, tests and assignments. Edmodo offers the possibility for the teacher to enroll (add) his / her students only by entering their name, without specifying the e-mail address. This is especially suitable for students under the age of 13 [6].

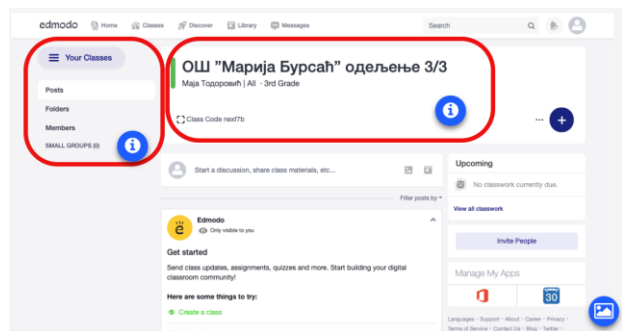

[6] Figure 3. Appearance of the Edmodo interface



#### D. Google Classroom

Google Classroom is a free web platform developed by Google. Google Classroom integrates documents, worksheets, slides, gmail, and calendars into a cohesive platform for managing student-teacher communication. Students can be invited to join the lecture via a private code or are automatically imported from the school domain. Teachers can create, distribute and mark assignments within the Google ecosystem. Each class creates a separate folder in the appropriate user facility, where the student can submit papers assessed by the teacher. Task due dates are added to Google Calendar, and each task can belong to a category (or topic). Teachers can track each student's progress by reviewing the document's revision history, and once they receive grades, teachers can return the work along with comments. The classroom has mobile applications, available for iOS and Android [7] [8].

This is definitely the platform that has experienced the greatest expansion in the number of users, during the implementation of distance learning. It is characterized, above all, by simplicity and clarity. An active gmail account is required to use. It can be accessed via the link <https://classroom.google.com>.

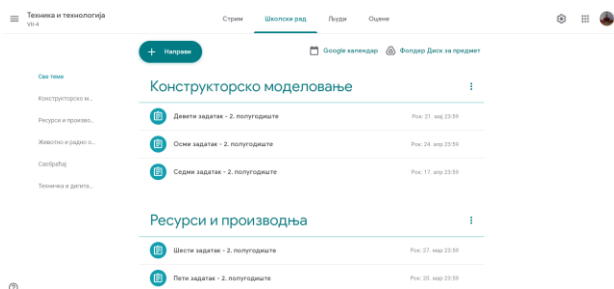
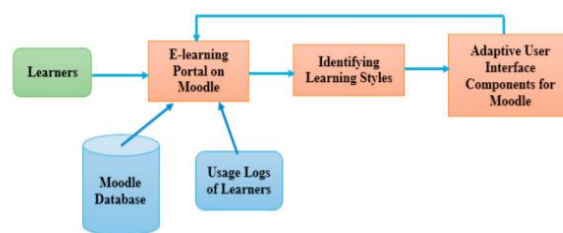

Figure 4. Google Classroom layout

#### E. Moodle

This is the most common protoform for learning management in the world. Moodle is a free open-source learning management system written in PHP and distributed under the GNU (General Public License). Moodle is used for blended learning, distance education, inverted classroom and other e-learning projects in schools, colleges and other sectors. It is used with customizable management features to create private websites with online courses [9].

Moodle requires installation on a web server. Many LMS platforms use mudl as their basis. An example of this is the platform of the Ministry of My School.



[18] Figure 5. Moodle Architecture Overview

#### IV. RESEARCH METHODOLOGY

The research methodology in this paper is based on the experiences of primary school teachers, who were actively involved in the implementation of distance learning through certain platforms. For these needs, a Google questionnaire was created, in which the respondents were asked to first give an answer as to which platform they used for the implementation of distance learning. Then, in the continuation of the questionnaire, teachers are asked to evaluate the used platform in accordance with the standard ISO / IEC 9126-4, which defines the quality metrics of the software in use.

##### A. Data collection

The Google Questionnaire was used as a data collection tool. Created questions can be divided into two groups, ie general questions and questions related to software quality assessment according to the ISO / IEC 9126-4 standard. The first group contains questions, to which the respondents answer by marking the answers or choosing one of the offered answers from the drop-down list. The My School MPNTR platform is not offered in this questionnaire, due to the fact that it is intended exclusively for students, without a defined teaching role. The questions and answers are given in the table below.

TABLE 1. QUESTIONS AND ANSWERS FROM THE GENERAL GROUP

No	QUESTIONS	TYPE OF ANSWER
1.	What subject do you teach?	Drop-down list
2.	How many years of experience in education do you have?	marking
3.	Which platform did you use during distance learning?	marking

The second group contains the offered characteristics of the software, according to the ISO

/ IEC 9126-4 standard, which the respondents rated with a rating scale from 1 to 5.

### B. ISO / IEC 9126-4 standard

The ISO / IEC 9126-4 standard defines the software quality metrics in use. It is part of a wider family of software standards ISO / IEC 9126, which provide guidelines for evaluating software quality. Other parts of ISO / IEC 9126 are [10]:

- ISO / IEC 9126-1 - Software quality model
- ISO / IEC 9126-2 - External software quality metrics
- ISO / IEC 9126-3 - Internal software quality metrics

Quality metrics (model) in use are available when the final product is used in real conditions. According to the standard, internal quality determines external quality, and external quality defines quality in use. The elements of software quality in use are effectiveness, productivity, security, and satisfaction (Figure 6).



<sup>[10]</sup> Figure 6. Software quality model in use according to ISO / IEC 9126-4

Effectiveness, in this research, refers to the degree of contribution of the used software, the success of the realization of the curriculum. Productivity is a characteristic that shows the achievement of the teacher's goals in the work in proportion to the invested resources (time, hardware, etc.). Security - is a characteristic of software that defines the procedures, methods, procedures and standards that ensure the integrity of a particular software system and related data. It also defines the security of user data (data for authorization, authentication). Satisfaction is the degree to which a software product or system provides functions that meet the needs of teachers in the implementation of distance learning.

### V. RELATED RESEARCH

The lack of adequate related research is quite expected, bearing in mind that the paper was written in real time. Several references, with similar themes, that were available at the time of writing are listed in the literature under ordinal numbers [11], [12]

and [13]. Since the methodologies and goals of the mentioned research are different in relation to this paper, the similarity remains exclusively thematic.

A partially similar research was conducted on a sample of about 15,000 primary and secondary school teachers by the Institute for the Advancement of Education and Upbringing. The survey asks, among other things, to search for and mark the platform, which was used during distance learning, without entering into a deeper evaluation. Also, answers were offered as to whether the respondent used another LMS, whether he used only communication tools or none of the above. This research confirmed the dominance of the Google classroom platform.

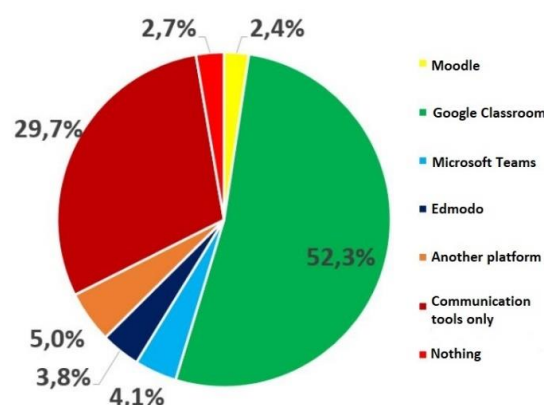

<sup>[14]</sup> Figure 7. Part of the ZUOV survey

### VI. RESULTS AND DISCUSSION

116 class and subject teachers from the territory of the Srem administrative district participated in the research. The results showed that by far the most teachers used the Google classroom for distance teaching (54.3%). A large number of teachers stated that they used another platform (31%), followed by Edmodo (8.6%), Moodle (3.4%), Microsoft Teams (2.6%). All of the above is shown in the image below.

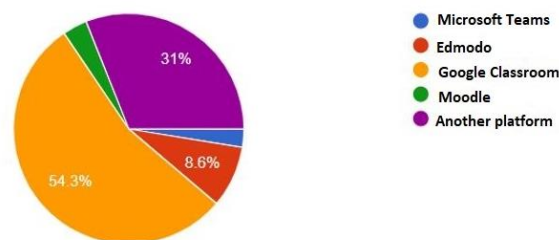

Figure 8. Percentage of platforms used

Regarding the assessment of the used platforms according to the ISO / IEC 9126-4 standard, most teachers gave a grade of 4 on the assessment scale. The mentioned grade for effectiveness was given by 54.3%, for productivity by 51.7%, for safety by 44%

and for satisfaction by 44.8% of teachers. The overall average score is 3.94 for effectiveness, 3.84 for productivity, 4.11 for safety and 3.99 for satisfaction. As Google Classroom was identified by respondents as the most used platform, a more detailed analysis is given in the next subsection.

#### A. Detailed results for Google Classroom

The Google classroom was used by 63 respondents, or 54.3%, for distance learning. Teachers gave average scores of 3.94 for effectiveness, 3.84 for productivity, 4.11 for safety and 3.99% for satisfaction for this platform. Of the 63 respondents, 19 are primary school teachers, which is about 30%, and 44 (70%) are subject teachers. The graph below provides an overview of the average grades given by classroom and subject teachers, where it can be seen that the grades of the required characteristics are approximately the same, ie that teachers have approximately the same opinion about the experiential effectiveness, productivity, safety and satisfaction of Google classroom. whether it is a class or subject teaching. Based on this, it is concluded that the mentioned platform is almost equally useful for the implementation of distance learning, both in lower and higher grades.

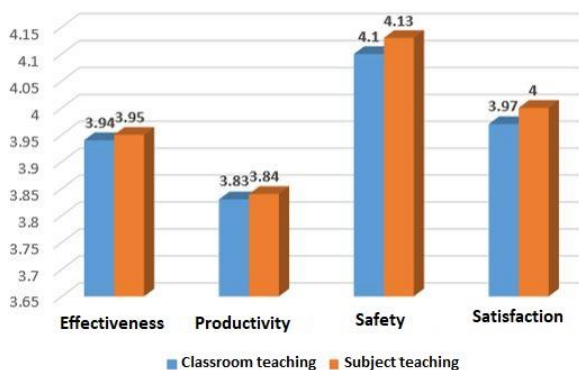

Figure 9. Comparative presentation of grades for class and subject teaching

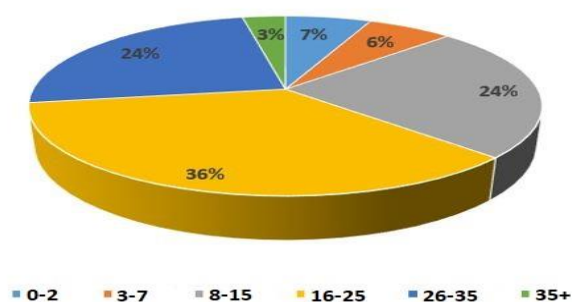

Figure 10. Percentage presentation of teachers by years of experience

It can be seen from Figure 11 that the largest percentage of teachers (36%) belong to the group with 16 to 25 years of experience. If we add groups 8 to 15 and 26 to 35, where the percentage is 24%, we come to the conclusion that the Google classroom platform is suitable for use by teachers of different ages, and not only those younger. This data also shows that the level of information literacy of older teachers is very high. The graph below provides an overview of the average scores by the three age groups that used the platform the most, where it can be seen that the two younger groups (8 to 15 and 16 to 25) gave approximately the same, while the older group (26 to 35) evaluated the offered characteristics with a shade lower, but again high grades.

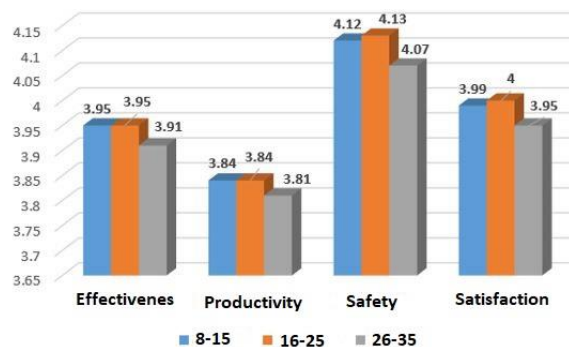

Figure 11. Estimates of characteristics for the three most common age groups

## VII. CONCLUSION

The sudden transition from classical to distance teaching has led to great organizational challenges, both for the line ministry and for the teachers themselves. Relocating the entire educational process to the virtual world has been particularly challenging for primary school teachers because their students do not possess the level of IT skills as students and high school students. Also, a large number of teachers themselves have so far not encountered e-learning platforms in this way. However, despite all the difficulties, the general conclusion is distance learning in the second semester of the 2019/20 school year. passed successfully.

Most teachers opted to use the Google Classroom as a platform, or 54.3%. The same platform received high marks for effectiveness, productivity, safety and satisfaction according to the ISO / IEC 9126-4 standard (average around 4). During this period, the Google classroom entered a remarkable expansion of usage, which preceded some platforms that were still in use by a number of

teachers (Moodle, Edmodo, etc.) even before the transition to distance learning. The reason for this lies in the extremely intuitive interface and ease of access through the google account that most teachers and students use before for classic e-mail.

The experience gained during this period is extremely valuable because it gives good guidelines on how to prepare for the next school year. It is possible that the use of LMS will remain as an auxiliary tool, which will serve as a supplement to the reduced classical teaching.

#### REFERENCES

- [1] Professional Instruction of the Ministry of Education, Science and Technological Development to the Principals of Primary and Secondary Schools, No. 601-00-9 / 2020-01 of 16.3.2020. J. Clerk Maxwell, *A Treatise on Electricity and Magnetism*, 3rd ed., vol. 2. Oxford: Clarendon, 1892, pp.68–73.
- [2] Davis, B., Carmean, C., & Wagner, E. (2009). "The Evolution of the LMS : From Management to Learning". *The ELearning Guild Research*. 24.
- [3] Marić F. and Šćepanović D. (2019). Training course for project leaders "Digital Classroom", ZUOV and MPNTR
- [4] <https://www.mojaskola.gov.rs/> , accessed April 2020.
- [5] *Teacher's Guide to Getting Started in a Microsoft Teams Program Adapted for Distance Education*, MPNTR 2020.
- [6] Finita Dewi, EDMODO: A Social Learning Platform for Blended Learning Class in Higher Education, *Research in Education Technology: Pedagogy and Technology Journal*. SEAMEO-SEAMOLEC. Vol XI/No.2/2014
- [7] Ketut Sudarsana, Ida Bagus Made Anggara Putra, Nyoman Temon Astawa and Wayan Lali Yogantara, The use of Google classroom in the learning process, 1st International Conference on Advance and Scientific Innovation (ICASI)
- [8] Etherington, Darrell (May 6, 2014). "Google Debuts Classroom, An Education Platform For Teacher-Student Communication". *TechCrunch*. AOL. Retrieved April 28, 2017
- [9] Rogers, Patricia L. (2009-01-31). *The Encyclopedia of Distance Learning*, Vol1. ISBN 9781605661995.
- [10] ISO/IEC TR 9126-4:2004 Software engineering - Product quality - Part 4: Quality in use metrics, <https://www.iso.org/standard/39752.html>, accessed April 2020.
- [11] Benjamin Luke Moorhouse (2020): Adaptations to a face-to-face initial teacher education course 'forced' online due to the COVID-19 pandemic, *Journal of Education for Teaching*, DOI:10.1080/02607476.2020.1755205
- [12] Reza Rachmadtullah, Marianus Subandowo, Rasmitadila, Megan Asri Humaira and others, „Use of Blended Learning with Moodle: Study Effectiveness in Elementary School Teacher Education Students during The COVID-19 pandemic”, *Research Gate article*, May 2020.
- [13] Razia Isaeva, *How Covid-19 is reshaping teaching and learning: A perspective from Khazar University*, Khazar University Press, ISSN: 2218-2772
- [14] <https://zuov.gov.rs/rezultati-ankete-sta-15-000-prosvetnih-radnika-misli-o-ostvarivanju-obrazovno-vaspitanog-procesa-putem-ucenjanadaljina-daljinu/>, accessed 18.6.2021.
- [15] Sucheta V. Kolekar, Radhika M. Pai\*, Manohara Pai M.M., *Adaptive User Interface for Moodle based E-learning System using Learning Styles*, 3rd International Conference on Computer Science and Computational Intelligence 2018.
- [16] Buthaina Almur Salim Al Handhali1, Anwar Tareeb Najim Al Rasbi2 & Dr. Sherimon P.C, *Advantages and Disadvantages of Learning Management System (LMS) at AOU Oman*, ARIV - International Journal of Technology Vol 1 Issue 2 2020

# Video Games as a Promising Educational Option For all Ages

R. Zamurović\*, D. Radosav\*

\*University of Novi Sad, Tehnical faculty „Mihajlo Pupin“, Zrenjanin, Serbia  
zamurovicrastko@gmail.com

**Abstract – This paper processes the idea of using video games for the purpose of education as well as exploring the relationship the current generation has with them.**

## I. WHAT MAKES A GAME?

The most widely accepted definition is that a game is any activity that is undertaken for the pleasure it provides regardless of the final result. What helps a game to be repeated many times is the pleasure which it produces, often seen in children (as well as adults) having their favorite game and replaying it many times regardless of how simplistic it might be.

## II. CHILD'S PLAY

The basic stimulus for a child's development is play. Lack of activities that produce pleasure causes tension and irritability in the child. The more often these unpleasant conditions occur, the harder it is to develop abilities that the child has. By following the way a child plays, it is possible to understand how they experience the world around them, how they develop, and in which areas of development additional encouragement is needed. Play encourages all areas of development in a child: intellectual, moral, physical, perceptual, emotional, social and so on. By arranging cubes and similar materials, the child compares objects, sorts them according to different criteria, develops a sense of color, shape, etc. The child develops curiosity, perception and observation, but also creativity, attention and memory. Through play, the child experiments and tests their abilities, without having to take full responsibility for their actions. A game in which the child is successful and progresses by overcoming higher levels, leads to an increased degree of self-confidence and security in communication with peers. In addition to the above, another important function of game is that it could be a means to control behavior. Through various games, the child prepares for roles in real human relationships, whether they are peers or adults. The child becomes aware that there are others in their

environment and that they should be taken into account. By respecting the rules of the game, the child learns responsible behavior. Most games encourage a child's physical development, as they require certain body movements. So that muscles develop and correct posture is established.

## III. MATURE AGE

Considering that through growing up, numerous obligations appear that, in childhood, the individual did not even know existed, free time becomes shorter and shorter, and fun activities become less frequent or non-existent. Most people in adulthood try to maintain the vitality of the organism, by going to sports activities at least once a week (eg football with colleagues from work, basketball, recreational swimming). Games free a person from the commercial interests they are surrounded by on a daily basis, completely liberating and relaxing them, returning them to their original state and providing an opportunity for further development. Play signifies joy, contentment, freedom, carefreeness. Today's problems: depression, aggression, melancholy are more present in people who play less, while people who do play are resistant, more adaptable to changes in their environment and easier to cope with stress, as the proverb goes “All work and no play makes Jack a dull boy”. Since games are not a response to biological needs, the person in it is to some extent free from emotional burdens experiencing pressure or stress, the brain is focused on processing above the frame, not disturbed by fear of failure, so it's awake and active but not stressed. During play, the brain is preoccupied with ideas, rules and actions of the game. In adulthood, man is limited by environment, time, space, obligations, so they play as a sideline, which is again isolated in a special way, and takes place within precisely defined boundaries of time and space, so it creates a sense of displacement from their environment and transition to another, virtual one. There are special play areas: game boards,

limited spaces, chessboards, rings, stadiums, arenas and so on. Going beyond those limits, either accidentally or by mistake, is forbidden and it brings with it certain consequences, penalty points and the like. Most games are limited by time: each game starts and ends at the agreed sign, or the duration is predetermined. The reasons why it is necessary to play in adulthood are numerous, playing leads to calm, the ability to focus on certain details, the development of creativity etc. Games improve brain function, includes the activity of the left and right halves of the brain, left – analytical and tells what to do next, which step to take, which strategy will lead to victory, and right - artistic allows you to enjoy recognizing colors, shapes, ... actively involving brain function can affect dementia in later years in terms of its prevention, memory exercise and involvement in intellectually complex activities reduces the risk of this ability impairment. Games improve relationships, communication at all levels, sharing fun and laughter with others encourages empathy, intimacy and trust. "Man is an eternal child of the game (homo ludens) because he is constantly amazed and wild, he creates and destroys, he believes, so he doubts. In a constant game, forget yourself, surrender, wake up dreaming." <sup>1</sup>

#### IV. A GAME OF HISTORY

Games exist and were studied even at a time when people were not aware of their theoretical basis. Play has existed since the existence of human society, since the existence of a child. It was created long before the first schools, it is as old as education itself. Its beginnings are somewhere in the prehistoric past and present in all parts of the world, it was nurtured by the entire human race, and it has always been a basic activity and an integral part of growing up. Numerous archeological excavations, found toys, drawings in caves, on pottery, etc. indicate this fact. Play followed the child and was given importance much earlier before physical education was introduced in schools and before school became an institution. The general development of society, socio-historical conditions often dictated the way children play with toys and engage in sports activities. Attention to it was paid depending on economic conditions, levels of culture and understanding of games and sports as life's needs. It was once considered an evil that should be nipped in the bud, because it was believed to dull younger generations, fortunately, there were not

many such views and they did not last long enough to cause bigger problems to humanity. Ancient philosophers were among the first to research the concept of play, but they saw it only in the function of helping learning, getting used to respecting regulations and rituals, that is, as a school for adult training. Socio-economic events, i.e. current social arrangements, had a decisive influence on the development of the game throughout history, analyzing the philosophical and educational systems of individual peoples and cultures. The ruling classes realized very early on that activities through play could be used to achieve certain socio-political goals. This is confirmed by the examples of ancient China, India, Egypt, Persia, Sparta, Athens, Rome and others. In the works of the most famous Chinese philosopher Confucius (551-479), the role of physical exercise is positively assessed. China took sports disciplines seriously, in the first place was archery, which combines precision, physical strength and deep thinking on how the arrow will achieve the right result. It should be emphasized that running was also popular among the people. In the Yuan dynasty, there was a competition that was twice as long as a marathon and began 600 years before the first marathon. In Persia, the main focus was on the physical development of the youth, with the main task of developing physical strength and speed, as well as spiritual freshness, patience and modesty. According to Herodotus, the youth in Persia had three most important tasks: to learn to ride a horse, to shoot an arrow, and to tell the truth, the latter is very interesting, since for the first time physical and spiritual values are mixed. In addition to the classics, games were also popular: polo hockey on the field, dances with weapons and such. It is known that upbringing in Sparta did not have the character of gentle care for young people, on the contrary, children were exposed to strict and cruel conditions, in order to get used to patience and obedience. Physical fitness was taken into account, so here too play had the form of physical exercises with competitions. Priority was given to: running (barefoot), jumping, discus and javelin throwing, wrestling, singing, etc. As for Athens, Plato and Aristotle tried to make the gymnastic system a means of general education of the Greek youth, and not only their physical abilities. It was considered that whoever does not know how to swim is the same as an illiterate person. The Greek understanding of physical education is still relevant in the world today, and it was also done through play. Children's natural tendency towards play was not neglected, so children grew up with toys: dolls, swings and different animal models. In Kant, there

---

<sup>1</sup> Др Владета Јеротић,  
<http://www.politika.rs/sr/clanak/371533/Drustvo/Covek-na-putu-od-bogova-do-Boga>

is a philosophical reflection on play that will, soon after the publication of his writings too become one of the central categories of his philosophy, and especially of aesthetics. As the main characteristic of play Kant, as opposed to work, emphasizes freedom from goals, needs and the struggle for survival. According to his interpretation - play is free from responsibility and consequences, it is "purposelessness without purpose" (Kant, 1975, 109). Philosophers of the modern age see art as the highest form of play, as the highest possibility in the medium of illusion. When asked whether Michelangelo's David stands in a Florentine square or in his "imaginary" world, Fink answers: here and there; he is a marble block but also a young man before the struggle for life and death (Fink, 1979, (1) 416). David's world emerges on the ground of the unreal, which is unreal and super-real at the same time. According to his philosophy, while creating and playing, man lives in two dimensions, in ordinary reality on one hand, and in the imaginary sphere that is built as an imaginary world of play on the other. What connects play and art is precisely that world of the imaginary which, as a real possibility, is more real than any reality. Games lead to an understanding of the world and as a final creation they are thus close to art.

#### V. VIDEO GAMES

It is safe to say that life today is completely computer dependent. It may sound a little catastrophic, but the facts speak for themselves. There is a well-known joke that reads "If satellite signals disappeared, half of the inhabitants of Asia would not know how to return home from work." Much professional literature has been written about the importance of computers, and the author has no pretensions to deal with this topic himself, but they intend to analyze the importance of a huge field of computer science and informatics, as two separate and at the same time inseparable scientific disciplines, the author will explore video games. Of course, not everyone understands this area, a good number of computer users believe that this is an area that leads to "dumbing down" the population, reducing existence to sitting in front of a screen and wasting time. The fact is that this is an industry that is constantly evolving, has huge opportunities huge commercial significance and if used correctly and selectively, an incredible educational significance, at least as much as commercial. Such influence of games and their spread to other media is reminiscent of movie sagas of the second half of the XX century, Star Wars and Star Trek, because both universes

penetrated first into music, then into literature and comics, and with the advent of computers into games themselves. This indicates a pattern of new media entering cultural life. Films such as Avatar suggest a different type of relationship between the film and the digital: not only do they take on concepts typical of games, but they also use techniques that originated in the gaming industry to create the franchise itself.

#### VI. GAME DESIGN

Computer games are games that are played on personal computers, as well as on mobile computer devices. The original intention of the creators of games was to entertain the users, but there are more and more video games of an educational nature, intended for different training exercises and the like. In order to develop a video game, it is necessary to know and apply complex software, as well as to use the maximum capabilities of computer hardware which is very demanding in terms of speed, graphics capabilities and the like. In order to develop a functional video game, it takes hours and hours of planning, development of an idea, scenario and a complete project in general, which all in one word is called design. A whole team of experts is needed, of which each member who works on the development of a computer game, must have knowledge of informatics, i.e. computer science, must know all methods of developing numerous software, but also have knowledge in the field of information technology. The video game must be graphically well designed and done. Therefore, in addition to information, technological and software knowledge, knowledge in the field of graphic design is also required. A team working on the development of a computer game must have people who know the field of information technology well, but also graphic designers who specialize in video games. In the end, in addition to all these elements, there is a need to create a sound environment within the game, what will be heard when the character steps on different types of terrain or when he suddenly hits the ground after a big fall? For this reason, experts in shaping and manipulating sound are also being introduced into the team. Thus assembled teams of experts in sound creation, graphic design, software processing and many others, are capable of creating today's complex games.

#### VII. THE SOUND OF VIDEO GAMES

Sound in video games, depending on the type of game, is classified into several categories:

- Ambiences - these are audio files that are related to specific locations in the game. The name itself indicates the basic task of these files, which is to be the soundtrack of certain locations. The ambience contains several combined sounds that are specific to the location to which they are assigned and contribute to the realism of the game.
- Sound effects - These are all audio files that are played as game feedback to a player's action. They are divided into sounds that are "heard" by the characters within the game and sounds that are related to the player's interaction with the game.
- Dialog - this category includes recorded speech files. The task of the dialogue is to make the characters as realistic as possible.
- Music - reminiscent of the ambience, because it is played in a similar way, begins when the player enters a location, and ends with leaving it. The sound design process consists of editing audio files from sound effect libraries, and processing them through audio processors that change the overall feel of the sound.

#### VIII. EDUCATIONAL GAMES

It has already been said earlier in the text that most people when mentioning games first think of leisure activities, and not education. However, lately, more and more research shows that playing certain games can have a positive effect on learning. Educational games develop traditional skills, such as reading and mathematical logic. At the same time, they teach children teamwork, perseverance and a better understanding of the world around them. "The first educational video games were developed in order to improve certain activities via computers in order to improve the teaching process and practice tasks. Later, games were developed that contained simulation and strategy. Computer games are good for introducing children from preschool to the educational system, since they have all the elements that are attractive to children: a lot of color, animation, sound ... " <sup>2</sup> Although games can never replace classical learning in school, it is evident that educational games can greatly contribute to the development of many skills. Fun activities in the process of learning through play will only interest

children to join and understand the whole educational process as something positive, without even being aware of it. Simply put for a child through an example, every historical event that they "experience" within the game will be far closer and easier to remember than the one they only hear about or even see it in a movie. "By didactic games we mean those children's games which, in addition to having all the general properties of games, also contain specially adapted and built-in activities (perceptual, discovery, logical, speech, music and others). These games are subordinated to some special educational tasks that are set in advance. With the help of didactic games, children gain new experiences, moving from lower collective development to higher and more perfect forms." <sup>3</sup>

Computer games are gaining more and more importance every day, although the process is slow, it should be noted that the quality has significantly improved, there is a strict delineation of possible users of games. Classification by age leads to the creation of standards that game manufacturers must adhere to. Parents have a crucial role to play in controlling and choosing the games their children play. Children discover the cause-and-effect relationships of their actions in computer games very early. Information technology provides stimulation of the senses through the use of image, sound, tone, film. This kind of multimedia presentation stimulates children's attention and enables faster memory and learning. Games that are developed with the help of computers are divided into four groups: functional, imagination games, games with ready-made rules and construction games. Computer games are used in the educational process to improve and develop:

- Cognitive abilities
- Psychomotor abilities
- Attitudes and measures of value.
- Acquisition and acquisition of knowledge
- Interactive domain

#### IX. RESEARCH METHODOLOGY

The author of this paper chose a survey as a tool for non-experimental research that uses personal statements about opinions, beliefs, attitudes and behavior as the basic source of data. The research was conducted on a sample of 180 respondents,

---

2

[https://www.researchgate.net/publication/284696549\\_Educational\\_Game\\_Model\\_for\\_Pre-School\\_Children](https://www.researchgate.net/publication/284696549_Educational_Game_Model_for_Pre-School_Children)

---

3

<http://doiserbia.nb.rs/phd/fulltext/NS20130709NAMESTOVSKI.pdf>



which ensured the representativeness of the sample, and thus the most important epistemological assumption of this type of research. Since the service is mostly used in the field of public opinion research, attitudes or information, the author of the paper believes that this type of research is ideal for the topic covered by this paper. The author uses an analytical (explanatory) survey that follows the logic of experimental research and is aimed at testing the hypotheses. The analytical survey can prove cause-and-effect relationships, which is directly related to the questions that the author will try to get answers to from the respondents, who are mostly high school students. The aim of this survey is to investigate the extent to which high school students are aware of the impact of computer games, on their personal physical and mental development, their relationship with others and the environment in general, and how games can be used for personal gain in terms of education and expanding knowledge. Computer games, although still at the mercy of older populations (primarily parents), are increasingly entering the educational sphere, and are developing positive qualities in consumers, in terms of logical reasoning, decision-making and the ability to separate good from bad. In the preparation of this paper, the methods used were analysis and synthesis, as well as the statistical method when processing the results. In the whole world, the school year 2020/2021 takes place in changed circumstances compared to previous years, due to the Covid19 pandemic. For that reason, the author considered that optimal results would be given by research using questionnaires, which the respondents filled out online. The results were statistically processed. The sample of research consisted, mostly students of the high school "Dušan Vasiljev" in Kikinda, 180 of them. The ratio of age and gender of the respondents is presented in Figures 1 and 2. (blue = male, red = female, one student responded helicopter for unknown reasons.)

Pol  
 180 odgovora

- Muški
- Ženski
- Helikopter

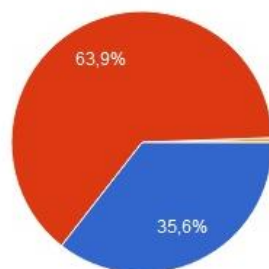

Uzrast (u godinama)

180 odgovora

- <10
- 10-15
- 15-18
- 18-21
- 21-30

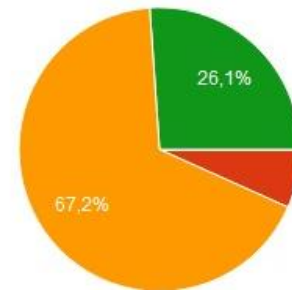

The author created a Google questionnaire for the research:

<https://docs.google.com/forms/d/e/1FAIpQLSfyToYc6i4qJmznOIEPZxD51o-EhJPIpqphtWJq3IPDrZjN8A/viewform>

The questionnaire contained 10 questions; the first two questions were informative, gender and age of the respondents, while the other eight were aimed at obtaining data on the importance of computer games for the population surveyed. The questionnaire is not of the uniform type, it contains questions that have the possibility of multiple choices, checklists, questions to which the respondents enter the answers in the appropriate forms and the like. The first two questions related to the percentage of students who play games: (blue = yes, red = rarely, orange = no)

Da li igrate igrice?

180 odgovora

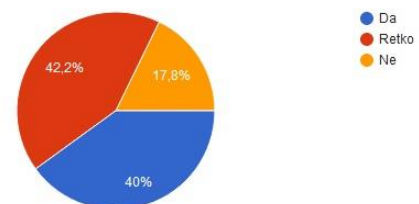

Da li smatrate da se igranjem igrica može nešto naučiti?

180 odgovora

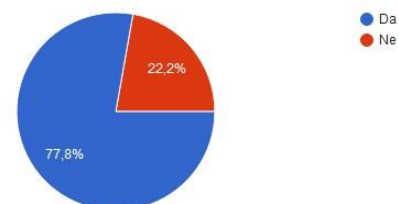

The third question is closely related to the previous one, the respondents are given the opportunity to enter the answers themselves, if they answered positively, ie to explain why they think

that it is not possible to learn anything by playing games. - The largest number of respondents 45.6% believe that games facilitate learning a foreign language, - 21% of respondents believe that computer games encourage logical thinking and the ability to make quick decisions. - 21% of respondents believe that computer games encourage reflexes, good coordination of movement and coping in space. - 10% of surveyed students believe that games introduce players to history and important historical events. Here are some interesting answers:

1. It depends on the type of game. If it is chess or something similar, I believe that it is possible to develop cognitive abilities and educate yourself to some extent. If it is a shooter ... I don't mind if it is played moderately (less than once a day) but nothing can be learned in that case.

2. I think that you can learn everything from games depending on which game it is. In some games we practice quick thinking and decision making, reflexes, coping and in general whether we depend on someone else or we are self-sufficient and do not need to trust anyone.

3. Because they are only there to take our time and to fool us, I don't believe I could learn anything smart there. After all, it all depends on what kind of game it is.

The fourth question refers to the types of games, surprising the variety in the choice of games, from sports, adventure, through war, social games, educational, all the way to complex thinking. The fifth question gives respondents the opportunity to choose, in their own opinion, the most important elements of a game:

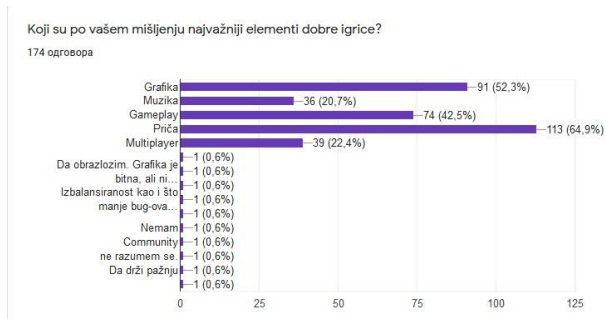

When asked if they knew the names of some well-known companies in the world of games, 10.6% of respondents answered in the negative, 10.6% had heard of Rockstar Games and Epic Games. The answers to the seventh question show how familiar the respondents are with the commercial side of the computer game industry:

Šta mislite, koja od ovih industrija je bila najprofitabilnija 2019. godine:

178 odgovora

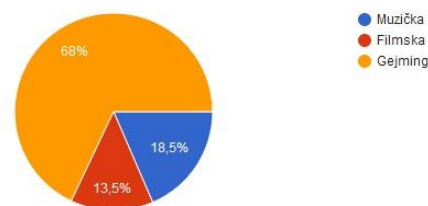

Da li sebe vidite u gejming industriji u budućnosti?

179 odgovora

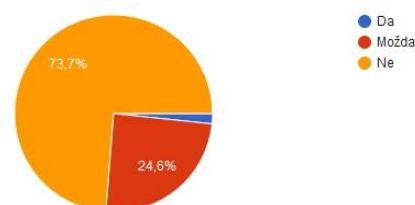

The previous chart refers to the eighth question, which is closely related to the following ninth: To the question "If you worked in the gaming industry, what would you like to be your job?" - 19.32% of respondents answered that they do not want to work in this field, a good part would like to work on screenplay and to design characters, and the smallest share belongs to developers. Here are some interesting answers:

1. I would like to be involved in a project to develop a classic first person shooter, and to design a weapon for that game that would be in the game.

2. I'd like to be the person who tries out new games and gives an opinion to the company. If that job exists at all.

3. I would like to create music for games.

To the last, tenth question: "Have you independently researched something that could help make games?" 95% of respondents answer in the negative, the answer of one student is interesting: Yes, a better presentation of games to parents would help in a bigger picture, because most parents think that video games make children violent, or deny them in the form of learning, for example, I learned to write, read and speak English from video games.

## X. CONCLUSION

Based on the analysis of the results of the questionnaire, it can be said that the goal of the research has been fully achieved, people of this age are aware of the pros and cons of the world of

computer games, are able to select the content they need and eliminate redundant parts. However, there is a noticeable tendency of "starmal" answers, in which respondents try to give answers in accordance with, according to their beliefs, the current situation in society, which is still not in favor of computer games and treats them exclusively as a means of entertainment. The initial hypothesis of the research was confirmed, the respondents do not use computer games exclusively for entertainment purposes, games of this type quickly cease to hold the user's attention. Games with a quality script, a good basis for learning new content, a historical background, are far more interesting for this population. Computer games are a really promising option for the generations to come, you just need standards and protocols to precisely define the boundaries and ways of use, in order to have an educational function to a greater extent than has been the case so far.

## REFERENCES

- [1] [HTTPS://WWW.UZELAC.EU/PREDAVANJA/02\\_UZELACMIGRAKAOFILOZOFSKI%20PROBLEM.PDF](https://www.uzelac.eu/predavanja/02_uzelacmigraKaofIlozofski%20problem.pdf)
- [2] [HTTPS://REPOZITORIJ.KIF.UNIZG.HR/ISLANDORA/OBJECT/KIF%3A79/DATASTREAM/PDF/VIEW](https://repositorij.kif.unizg.hr/islandora/object/kif%3A79/datastream/pdf/view)
- [3] [HTTPS://STARTIT.RS/ZVUK-MAD-HEAD-GAMES-IGRE-GAME-DEV/](https://startit.rs/zvuk-mad-head-games-igre-game-dev/)
- [4] [HTTPS://WWW.RESEARCHGATE.NET/PUBLICATION/343725895\\_ZASTO\\_SU\\_L\\_KAKO\\_VAZNE\\_VIDEO\\_IGRE](https://www.researchgate.net/publication/343725895_Zasto_su_l_kako_vazne_video_igre)
- [5] [HTTPS://ZIR.NSK.HR/ISLANDORA/OBJECT/UNIPU:52/PREVIEW](https://zir.nsk.hr/islandora/object/unipu:52/preview)
- [6] [HTTPS://JOURNALS.SAGEPUB.COM/DOI/10.1177/1046878113514808](https://journals.sagepub.com/doi/10.1177/1046878113514808)
- [7] [HTTP://WWW.FTN.KG.AC.RS/KONFERENCIJE/TIO2014/PDF/511%20LAZIC.PDF](http://www.ftn.kg.ac.rs/konferencije/tio2014/pdf/511%20Lazic.pdf)
- [8] [HTTP://WWW.FTN.KG.AC.RS/DOWNLOAD/SIR/SIR%20JANA%20UJASIC%208812014.PDF](http://www.ftn.kg.ac.rs/download/sir/sir%20jana%20ujasic%208812014.pdf)
- [9] [HTTPS://WWW.RESEARCHGATE.NET/PUBLICATION/284696549\\_EDUCATIONAL\\_GAME\\_MODEL\\_FOR\\_PRE-SCHOOL\\_CHILDREN](https://www.researchgate.net/publication/284696549_Educational_Game_Model_for_Pre-School_Children)

# Case Study: Which Math Topics Students Have a Problem with when They Start University Studying

E. Karamazova\*, M. Kocaleva\*

\*Faculty of computer science, “Goce Delcev” University, Stip, Macedonia  
elena.gelova@ugd.edu.mk, mirjana.kocaleva@ugd.edu.mk

**Abstract** - After graduating from high school, many high school students decide to continue their studies. The decision of what they want to be and what they will study is made by some of them a long time ago, but for some there is hesitation until the last moment. Due to some reasons, there are some of them who decide to continue their education at the technical faculty, even though they have problems with the topics they have learned in mathematics subjects. It happens to almost every new generation of students. That led us to research to find a solution and change that practice. In this paper, a questionnaire has been prepared for students in first study year from technical faculties with questions with which we want to see which mathematical topics students have the most problems with, i.e., facing difficulties in solving tasks. Research results are given by statistical analysis. Then, a conclusion from the results is drawn. Finally, in the end of the paper, a possible solution for the identified problematic topics is stated.

## I. INTRODUCTION

Technical faculties are a good choice for students. Many of the graduate's students of those faculties in a very short time find work and profit with their knowledge. But studying at a technical college cannot be considered an easy and simple obligation. By the end of high school, the students themselves already know which subjects are their favorite and which are not, which are easier to master and for which they need a lot of time and commitment. It is very important for the choice of faculty to study but also for the remaining period of life in which one must profit from the profession. But it also happens for different reasons: lack of financial means to study at a university in a city other than the hometown, lack of company, i.e., the other acquaintances did not enroll in that faculty, etc. In that way, under the influence of some factors, the future students decide, realize it and thus encounter other problems.

All the above affects the results achieved by students in colloquia and exams in the subjects they take in the current semester. Realizing the situation primarily for the difficulties in mastering the material in mathematics subjects taught by students at technical colleges, we decided to do research that wants to determine which previously studied topics

are difficult and incomprehensible to students. With the research we also want to determine the reasons for those difficulties that occur in students to find a solution, and to determine the reasons for those difficulties that occur in students to find a solution to eradicate them. It is important to do all this because mathematics is associated with many sciences. Without mathematical knowledge, we cannot explain some complex physical and natural phenomena, and cannot solve some more complex problems of everyday life. For that, students must learn at least mathematics at university level (low-level mathematics aimed for all university students, no matter on which faculty the students are). Paper [2] is aimed at data analysis of student's outcomes for the subject mathematics at university level. The results obtained from the overall testing is processed with statistical data analysis.

Methods used for learning such as: visual learning, verbal, physical, logical, and so on are also important to apply when studying some mathematical topics. In [1] authors want to see how and how many of the learning methods as: visual learning, aural, verbal, physical, logical, social, and personal learning are used in the study of computer science subjects [1]. All these methods are important because each one is good in its own way and has a big impact on the student, because it uses different parts of the brain.

Testing the knowledge of students at technical faculties is an interesting and intriguing research topic. In [3] authors analyze the impact of the knowledge acquired from the previous mathematical education in correlation with knowledge gained from lectures and exercises in Mathematics. Analysis was based on a test. Testing was conducted on students of technical faculties. One part of these students was tested with electronic tests, and the other part were tested on classical way. In the end of their research, they see that both ways i.e. classical and electronic diverge each other and we cannot precisely define what results are less reliable. Researchers in [7]

comparing the knowledge of students in the subject Calculus 2 from two technical faculties (marked in the paper as technical faculty 1 and technical faculty 2) in two different academic years 2014/2015 and 2015/2016. In 2014/2015 academic year, teaching was implemented with classical method with blackboard and chalk. In 2015/2016 academic year, teaching was implemented as combination of classical method with using of mathematical software such as MatLab and Mathematica.

Some math topics like the theory of Fourier series is complicated but their application is simple. Matlab as program package is suitable for easily plotting trigonometric series and the most convenient way for understanding their characteristics. In [4] authors present a program written in Matlab that plot partial sums of three trigonometric series, as a way of finding periodic functions that series represent.

Explanation for solving problems in the field of mathematics, solved in the Matlab programming language are given in [5]. The goal in [5] is to show that Matlab is a user-friendly programming language easy to use. Commands are invoked in a very simple way with a simple syntax, where in comparison with other programming languages; they require detailed knowledge of the language itself.

Connection between the mathematical notions and using the computer as educational support at university level is very important. In [6] mathematical notions used in integral calculations will be explained with help of computer program. The notions, indefinite and definite integral, their calculations and their applications can be easily understand using the computer programs for their presentation. Images obtained with computer programs allows the students to better understand and learn integrals and give them appropriate training to use this knowledge for current real problems. The authors use mathematical package Mathematica, as computer program to help learning integral calculations.

## II. RESEARCH METHODOLOGY

The research methodology consists of one test. The test contains 5 tasks and 5 questions, which are given below:

1. Draw the graphs of functions:  $f(x)=\sin x$ ,  $f(x)=\cos x$ ,  $f(x)=\tan x$ ,  $f(x)=\cot x$ ,  $f(x)=\log_2 x$ ,  $f(x)=2^x$ ,  $f(x)=5$ ,  $f(x)=x^2-6x+5$ .

2. Calculate 
$$\frac{\frac{4}{3} + \frac{1}{3} \cdot \left(-\frac{4}{5}\right) - 1}{\frac{3}{2} + \frac{1}{2} \cdot \left(-\frac{5}{6}\right) - 2}$$

3. Solve the system of equations with at least two methods 
$$\begin{cases} 2x + 5y = 3 \\ -3x + 2y = 1 \end{cases}$$

4. The base of a straight prism is a triangle with sides 15 cm, 26 cm and 37 cm. Calculate the area and volume of the prism, if its height is 12 cm.

5. Translate the given figure for 3 squares on the right and 1 square down. Then rotate the resulting image at an angle of  $90^\circ$  counterclockwise around the point G.

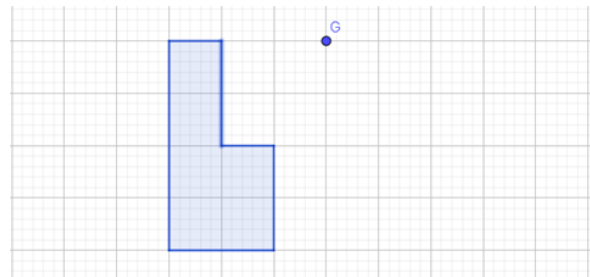

6. Which topics in math were harder for you to master in high school?

7. Did you have a high grade in math subject in high school?

8. Did you want to teach math in high school?

9. Why your choice was a technical college?

10. Do you want to work by profession when you graduate from college?

Students took the test online through Microsoft Teams. They had one hour and thirty minutes to solve the tasks and answer the questions. The test was answered by groups of 25 students from the first school years of academic year 2020/2021, from University Goce Delcev Stip.

## III. MAIN RESULTS

First, we will show the results for tasks. Results are given in Figure 1.

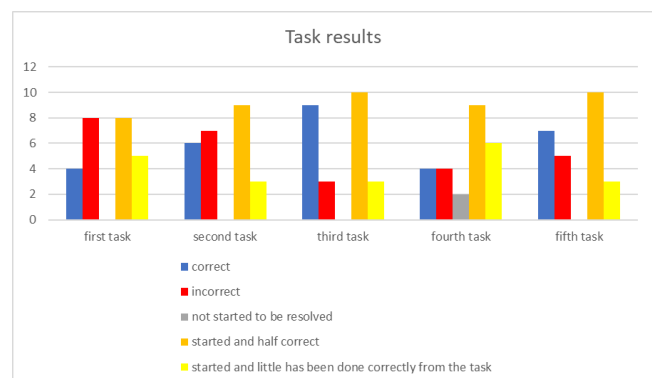

Figure 1. Task results

The blue column shows how many students correctly solved the appropriate task, the red how incorrectly, the gray how many did not start solving the task at all, the orange one started, and half correctly solved and the yellow one started but solved the task a little bit correctly. Figure 1. clearly shows that students have the most problem with the first and fourth task. For the third and the fifth we can see that they are not very problematic to solve, while for the second we can see that there is a few students who know and few that did not know how to solve it.

Statistical analysis of the results obtained from tasks are given in Figure 2 to Figure 6.

Statistics	
n	5
Mean	5
$\sigma$	2.9665
s	3.3166
$\Sigma x$	25
$\Sigma x^2$	169
Min	0
Q1	2
Median	5
Q3	8
Max	8

Figure 2. Statistical analysis of the results obtained for the first task

Statistics	
n	5
Mean	5
$\sigma$	3.1623
s	3.5355
$\Sigma x$	25
$\Sigma x^2$	175
Min	0
Q1	1.5
Median	6
Q3	8
Max	9

Figure 3. Statistical analysis of the results obtained for the second task

Statistics	
n	5
Mean	5
$\sigma$	3.8471
s	4.3012
$\Sigma x$	25
$\Sigma x^2$	199
Min	0
Q1	1.5
Median	3
Q3	9.5
Max	10

Figure 4. Statistical analysis of the results obtained for the third task

Statistics	
n	5
Mean	5
$\sigma$	2.3664
s	2.6458
$\Sigma x$	25
$\Sigma x^2$	153
Min	2
Q1	3
Median	4
Q3	7.5
Max	9

Figure 5. Statistical analysis of the results obtained for the fourth task

Statistics	
n	5
Mean	5
$\sigma$	3.4059
s	3.8079
$\Sigma x$	25
$\Sigma x^2$	183
Min	0
Q1	1.5
Median	5
Q3	8.5
Max	10

Figure 6. Statistical analysis of the results obtained for the fifth task

From the answers to the questions, we can see that students have problems with stereometry, planimetry, functions, fractions, inequalities, solving some equations and transformations. About the grade for subject Mathematica, several students had grade 5, some grade 4 and three of them grade 3. Half of students included in the survey wrote that they liked math subjects in high school, wanted practice tasks and spend good time learning math. The other half stated that they did not like math subjects because it was difficult to them to learn math, the lessons were not interesting, and they wasted a lot of time at home to master the material without some satisfied results. On the question “Why your choice was a technical college?” students gave different answers. Some because they had private companies in which they would work by profession after graduating from college, others because the majors they enrolled in were tempting, some because there were math subjects quite in the direction they enrolled in, and they wanted math but there were also answers that some enrolled because their parents were pressuring them to enroll in technical college. One student

replied that he had enrolled in this college because his friend had enrolled there. To the tenth question most students answered that they want to work after graduation with their profession. Only a few of them answered that after graduation they will think and decide what to do in their life and career.

#### IV. CONCLUSION

Considering the presented results, we can say that some of the students who were enrolled at the Faculty of Natural and Technical Sciences at the University Goce Delchev Stip in the first year have more mathematical topics that are problematic and uninteresting, of course taking in advance the opinion of all students. Thinking about how to overcome the difficulties and lack of interest in mathematics, we decided for the students involved in the research to include additional introductory classes before the regular lectures and exercises that will solve tasks from topics unclear to students. In the same classes, students will be able to ask questions about different topics and will be able to open discussions about some of their ambiguities related to topics in mathematics. We worked on tasks such as fraction operations, double fractions, solving equations, solving systems, probability.

For the other problems, uninteresting and difficult material such as geometric transformations, functions, circle and round, inequalities, we decided to advise students to use GeoGebra software when learning math topics. This will make the content more accessible to them, learning more interesting and the time spent learning math will not last for hours because the software will help them when they encounter problems.

Only by daily monitoring of students by monitoring their knowledge, their thinking, class behavior, commitment, activity at home and in class we can draw conclusions about the problematic mathematical topics among students in the latest generation of students. The importance of perceiving them is important to see what to pay more attention to in class and what to give as advice to students when studying independently at home.

#### REFERENCES

- [1] Kocaleva, Mirjana and Stojanova, Aleksandra and Zlatanovska, Biljana and Stojkovic, Natasa (2021) Примена на различни методи на учење на информатичките предмети. ФИЛКО - Зборник на трудови од Петта меѓународна научна конференција за филологија, култура и образование. pp. 163-168. ISSN 978-608-244-308-9
- [2] Loku, Lindita and Kocaleva, Mirjana and Zlatanovska, Biljana and Stojkovic, Natasa and Krstev, Aleksandar (2019) Analysis of students' outcomes for the subject mathematics at university level. *Balkan Journal of Applied Mathematics and Informatics*, 2 (1). pp. 23-28. ISSN 2545-4803
- [3] Zlatanovska, Biljana and Kocaleva, Mirjana and Krstev, Aleksandar and Zdravev, Zoran (2016) E - testing against classical testing in subject Mathematics. *Yearbook of the Faculty of Computer Science*, 4 (4). pp. 29-32. ISSN 1857- 8691
- [4] Stojanova, Aleksandra and Zlatanovska, Biljana and Kocaleva, Mirjana and Gicev, Vlado (2015) Obtaining functions from fourier series with Matlab. *A journal for information technology, education development and teaching methods of technical and natural sciences*, 5 (1). pp. 1-10. ISSN 2217-7949
- [5] Stojanova, Aleksandra and Zlatanovska, Biljana and Kocaleva, Mirjana and Rendzova, Dobrila and Stojkovic, Natasa and Bikov, Dusan (2019) Using of MatLab in the Mathematical Education. In: *ITRO 2019*, June 27, 2019, Zrenjanin, Republic of Serbia.
- [6] Zlatanovska, Biljana and Stojanova, Aleksandra and Kocaleva, Mirjana and Stojkovic, Natasa and Krstev, Aleksandar (2016) Mathematica as program support in the integral calculations. In: *TIO 2016 - Technics and informatics in education*, 28-29 May 2016, Čačak, Serbia.
- [7] Kocaleva, Mirjana and Stojkovic, Natasa and Stojanova, Aleksandra and Krstev, Aleksandar and Zlatanovska, Biljana (2017) Improving on teaching curriculum of Calculus 2 at Technical Faculties. In: *IEEE Global Engineering Education Conference (EDUCON)*, 25-28 Apr 2017, Athens, Greece

# Use of Educational Hardware and Software to Encourage Children to Code

D. Bikov\*, B. Shterjev\*\*, D. Siracheski\*\*

\* Faculty of computer science, “Goce Delcev” University, Stip, Republic of Macedonia

\*\* OOU “Dedo Iljo Maleshevski”, Berovo, Republic of Macedonia  
dusan.bikov@ugd.edu.mk, borces@gmail.com, d.siracevski@gmail.com

**Abstract** – Primary and secondary computer education nowadays requires modern aids to be included throughout the educational process. The purpose of these aids is to encourage children to code, to be more interactive, and to express their creativity. A new class of computing devices, called Single Board Computers (SBC) are tools that can help achieve the modern educational requirements as critical thinking, problem solving, creativity, interaction etc. The main idea here is to present a short survey of educational programmable hardware systems. In our case study, we want to point out the benefits of SBC and their impact on the education process.

## I. INTRODUCTION

Modern days require a modern educational approach. It is especially important to use modern educational tools in the computer educational process. These modern tools will ensure implementation of modern educational trends and practices. But it is more important that the use of modern practices is spread all over the educational process so that both children and teachers will have benefits from it.

There are many initiatives, projects, communities, and foundations which are committed on design and manufacturing of educational hardware and software. These educational computing platforms are intended to encourage children to code with the use robots such as Lego Mindstorms, and other programmable hardware platforms such as Arduino [5], BBC Micro:bit, Calliope mini and etc. Most of these educational devices are described as half the size of a credit card and, depending on the hardware board they have a processor (ARM, AVR, etc.), several sensors, Bluetooth, USB connectivity and additional development tool kit sets with different modules and accessories. The educational software is intended to simplify programming concepts and make it easier for teachers and children to teach how to code. This means that the educational software is customized for children of different ages with or without technical pre-knowledge to programing. All educational computing platform can be used to code on one or more high level programming languages as C/C++, Python, Java, JavaScript, etc. or visual user-facing

(drag and drop) block editors. There are various code editors, IDEs, interpreters, simulators, cloud-based programming environments and, etc. that are developed and intended for coding the educational hardware.

Other advantages of these educational devices are the small size, affordability, ease of use with simple installation, they have many tutorials and examples, good documentation, and good auxiliary materials for beginners. These devices can bring different dimension in the approach to encourage children to code so that at the same time they can have fun and acquire and learn new programing skills.

By using computing educational aids through the educational process children can work together on many different and interesting problems and immediately feel the benefits from their work. In fact, such an approach can bring various benefits within the whole educational process and not only in computing education. One of the goals could be finding different applications across the different school subjects. With this approach it will increase the interest, curiosity, concentration, creativity, and many other crucial qualities which are critical for personal development.

Our focus with educational hardware will be on SBC [13] (microcontrollers and microcontroller kits) that are designed and built for educational use. The target group of our interest are primary school students.

The paper is organized as follows: General description of SBC with some representatives will be covered in Section 2. Section 3 will be devoted to the advantages and disadvantages analysis of all presented SBC in the previous section. Questionnaire in two primary schools in Berovo conducted over the teaching staff will be referred in Section 4. In the end there is a conclusion section.

## II. SINGLE BOARD COMPUTERS

As the name itself tells us, SBC is a complete computer built on single circuit (printed) board, with



microprocessor(s) (MPU), memory, input/output (I/O) and other additional features required of a functional computer. On the other hand, a single-board microcontroller (MCU) is a microcontroller built onto a single circuit (printed) board. This board consists of all the circuitry necessary for a useful control task and is built with microprocessor, I/O circuits, a clock generator, RAM, stored program memory and any necessary support Integrated Circuit (IC).

The Central Processing Unit (CPU) is the logic electronic circuitry that control execution of the program instructions containing a computer program. Microprocessors consist of only a CPU, while the microcontrollers contain a CPU, Memory, I/O, all integrated into one chip. An MCU can be viewed as a single-chip computer, whereas an MPU has surrounding chips that support various functions like memory, interfaces, and I/O. One of the main differences between MCU and MPU is that a MPU will typically run an operating system.

In the next paragraph, we will briefly introduce the most popular and widespread educational hardware. Their basic characteristics and most important features will be included as well.

#### A. *Arduino*

Arduino (Fig. 1) is an open-source, easy-to-use hardware and software company, project, and user community that designs, develops and manufactures single-board microcontrollers and microcontroller kits [2]. Arduino boards can read inputs, light on a sensor, a finger on a button, etc. or can turn it into an output activating a motor, turning on an LED, etc. You can tell your board what to do by sending a set of instructions to the microcontroller on the board.

The Arduino hardware products are distributed under a CC-BY-SA license, while software is licensed under the GNU Lesser General Public License (LGPL) or the GNU General Public License (GPL). There various official Arduino boards are available from the official website or by the authorized distributors.

There are various microprocessors and controllers that are used to develop a range of Arduino boards. The boards are equipped with sets of digital and analog I/O pins that can be connect to various expansion boards, breadboards, modules, and other circuits. The boards contain serial communication interface and most of the model include Universal Serial Bus (USB) which, among the other things, are used for loading programs.



Figure 1. Arduino Uno SMD R3

The Arduino boards are based off an Atmel [3] 8-bit AVR, 32-bit ARM Cortex-M or Intel Quark (x86) microcontrollers with varying flash memory sizes, pins, and features. The microcontrollers can be programmed in any programming language with compiler that produces binary code for the target processor. Arduino can be programmed by C and C++ programming languages, using a standard API also known as “Arduino language”. Apart from traditional compiler toolchains, the Arduino provides open-source IDE and web editor.

Because of the simplicity and the accessible user experience, this platform takes part in thousands of different projects and applications. The software is easy to use for beginners and advanced users alike. Anyone, including children can start by following the step-by-step instructions of the kit or sharing the ideas online with the Arduino community.

Arduino simplifies the process of working with microcontrollers, and some advantages are low cost, Cross-platform (run on Mac, Windows, and Linux), simple, clear programming environment, open source, extensible hardware, and software

#### B. *Micro:bit*

The Micro:bit [8] (Fig. 2) is open source educational hardware originally created by the BBC [4] and collaborators for use in computer education in the UK. This device is with half size of credit card, and the boards are based on ARM Cortex-M microcontroller, flash memory, static RAM memory, require 3V power supply, it has two embedded accelerometer and magnetometer sensors, there are also two connecting interfaces Bluetooth and USB, two programmable buttons, a display that consists of 25 LEDs, and five ring I/O pins connectors. The device can be powered by either USB or an external battery pack.



Figure 2. Micro:bit

The second nearly identical Micro:bit board has been released in October 2020. This board is identified as v2. Mainly the differences between the boards are in the hardware configuration. Naturally, newer boards have better hardware such as microprocessor, more memory, and other new features.

There are two official code editors: Microsoft MakeCode [10] and MicroPython [9] for Micro:bit board that can run as a web application in the browser. These code editors are available on their foundation web site [8]. There are other non-official editors for programming on Micro:bit. Except the text-based programming, some of the editors provide programming of Micro:bit by visual block-based languages. There is a possibility to switch to the text-based code which is behind blocks. The programming languages that can be used for programming the Micro:bit are Python, JavaScript, C++, Pascal, etc.

This device is particularly designed with purpose to encourage children to code and build new things. It is designed to work alongside other systems to improve computing education. Alongside this board there is are different development kit sets with different modules and accessories that enriches board functionalities and applications.

### C. Calliope mini

Calliope mini (Fig. 3) is a tiny SBC developed for educational usage at German primary schools [6]. This initiative was been inspired by the BBC Micro:bit. The Calliope mini is in the shape of a star (Fig. 3) that prevents short circuits which is more secure for the children. It can be said that it's based on Micro:bit with ARM Cortex-M0 microcontroller, flash memory, RAM memory. This device has additional components such as a loudspeaker, microphone and RGB light-emitting diode, two Grove connectors, extended input and output options.



Figure 3. Calliope mini

The Calliope mini can be programmed in C++, JavaScript, Python programming languages. There are several editors that can run as web applications in the browser or as offline desktop editors. The visual development software that can be used to program Calliope mini includes Scratch [15] the Microsoft MakeCode based editor, Open Roberta Lab (NEPO) [12] and the Calliope mini Swift Playground (Apple App) [16]. There is also MicroPython support for the Calliope mini. Calliope mini kit set with accessories enriches board functionalities and applications.

### D. Additional remarks

There are other SBC that can be used in computing education but from various reasons that are not mentioned here. The Raspberry Pi, Banana Pi, GoWarrior, Omega2, etc. can be included to the category of educational hardware but because of their characteristics, software, and programming user interface, required level of knowledge of programming languages, their purpose is not very appropriate for our target group of users.

## III. ANALYSIS ON SINGLE BOARD COMPUTERS

The devices mentioned in the previous section are chosen for analysis because of their predefined purpose. These devices are specially designed computing educational platforms which are intended for the youngest population.

Each of the representatives have their strengths and specific characteristic. For analysis purposes, several will be considered as different categories to evaluate and compare. Apart from this, some of the categories will have greater weight during evaluation from the obvious reasons. For example, easy comprehensibility, simplicity will have greater value during the evaluation. Simplicity is it important for our target group.

To have a more general and efficient analysis there will be considered several main categories as software, safety use, range of applications, development tool kit sets, study documentation as

guides, books, tutorials, or videos. The comparison will be made upon the officially available hardware,

TABLE I. TABULAR SBC ANALYSIS

<b>SBC Categories</b>	<b>Arduino</b>	<b>Micro:bit</b>	<b>Calliope</b>
Software	Intended for students (basic knowledge)	Intended for children (beginners)	Intended for children (beginners)
Compactness and safety use	Various board with different shape and sizes	Credit card size	Shape of a star for safer use
Tool kit sets	Wide range of different tool kit sets	Starter set with additional accessories	Starter set with additional accessories
Range of applications	Wide range of education, home and cheap industrial - scientific application	Wide range of educational application	Wide range of educational application
Study documents	Various study materials intended for students	Various study materials intended for children	Various study materials intended for children
Simplicity of use and understand	Requires certain knowledge	Easy to use and comprehend	Easy to use and comprehend

software tools and documentation. Depending on the situation, we will mention important information from nonofficial sources. The intention here is not to make strict conclusion for the best educational SBC but rather to present general conclusions. This analysis can make it easier for teachers to choose educational hardware according to their personal preferences.

The analysis done in Table I only confirms the general conclusions so far. It is important to note that according to the analysis Arduino boards are for more advanced applications. These boards are intended for users with prior knowledge about programming languages and hardware. The main disadvantage concerning the software can be overcome by using nonofficial drag-and-drop Arduino friendly block coding editors as ArduBlock [1], EduKits [7], Open Roberta Lab (NEPO) [12], etc.

The general conclusion about the other two SBCs is mostly the same. Both are designed and developed for use in computer education, and they are intended for primary school students. Because Calliope mini was inspired by the Micro:bit, it can be said that in some way, it is his extended and improved version. It's needed to be mentioned that the shape of Calliope mini is safer for use. There is not an absolute winner between the two of them. The choice between them may depend on their own preference and their availability.

#### IV. TEASHING STAFF QUESTIONNAIRE

During the summer period primary and secondary high school teaching staff in Macedonia have a variety of activities including various trainings. With the support of British Council under the program “21st Century Schools” [14] there was an online course, Micro:bit Basics for Teachers [11]. Apart of this, there was an internal training for the teaching staff in secondary schools OOU “Dedo Iljo Maleshevski” and OOU “Nikola Petrov Rusinski” in Berovo. This was a good reason to carry out a questionnaire for the teaching staff that attended the training. The main aim of the results of this questionnaire is to obtain an assessment of the Micro:bit for their possible use in the educational process. It should be noted that the assessment is according to the teacher’s opinion and convictions.

The questionnaire contained fifteen questions with multiple possible answers. This questionnaire is about the educational process and use of additional aids as Micro:bit. Teachers from various age groups and with different professional profiles participate in the questionnaire. The number of teachers that participate in this questionnaire are 24. More general questions concerning the educational processes with the results are given in Table II. In Table III, questions are given with the results relating opinion about possibly use of the Micro:bit in the educational process. The results are presented with number and percentage.

TABLE II. MICRO:BIT QUESTIONNAIRE FOR TEACHERS, PART I

1. Do you think that students are interested to embrace new innovative learning methods that include modern aids?				
Answers	Yes, the most of them	Yes, but only a few in a class	No, they are not interested	
Results	11 (45.83%)	12 (50%)	1 (4.16%)	
2. Do you think that the way in which you are teaching influences on students’ motivation?				
Answers	Yes, it is crucial	Yes, but not always	No, the method is not important	
Results	9 (37.5%)	14 (58.33%)	1 (4.16%)	
3. How often do you use different teaching methods that include modern aids?				
Answers	Very often	Not very often	Never, I prefer traditional teaching	
Results	5 (20.83%)	16 (66.66%)	3 (12.5%)	
4. How often do you use a computer or other educational electronic device in a classroom when you are teaching a new unit?				
Answers	Always, when the unit allows	Not very often	Not very often, due to limited aids disposal	Never
Results	9 (37.5%)	8 (33.33%)	6 (25%)	1 (4.16%)

TABLE III. MICRO:BIT QUESTIONNAIRE FOR TEACHERS, PART II

5. Are you willing to embrace the use of education aids such as Micro:bit in your classes?			
Answers	Yes, always when the aids are suitable	Yes, but rarely	No, there is no use of this types of aids
Results	14 (58.33%)	6 (25%)	4 (16.66%)
6. Do you think that use of Micro:bit will encourage/motivate students to code?			
Answers	Yes, all will be encourage/motivate	Yes, but only few of them	No, it will not make the difference
Results	9 (37.5%)	13 (54.16%)	2 (8.33%)
7. Will you motivate students to use Micro:bit?			
Answers	Yes, very often	Yes, but rarely	No
Results	11 (45.83%)	11 (45.83%)	2 (8.33%)
8. Do you think that Micro:bit is simple for using and coding?			
Answers	Yes, it is simple	Yes, but for a certain group	No, it is complicated
Results	9 (37.5%)	13 (54.2%)	2 (8.3%)
9. Do you think that Micro:bit can helps you to improve and enrich the teaching plan?			
Answers	Yes, it will improve and enrich the teaching plan	Yes, but will takes me a long time than the usual planning	No, will not improve the process of planning
Results	5 (20.83%)	14 (58.33%)	5 (20.83%)
10. Do you think that with Micro:bit will be increase communication between students and increase your cooperation with students?			
Answers	Yes, will able to increase communication and cooperation	Yes, but will depends from the personal characteristic	No, doesn't increase communication
Results	8 (33.3%)	13 (54.2%)	3 (12.5%)
11. Do you think that use of this type of educational aids as Micro:bit can increase building and improve personal characteristics and skills as curiosity, concentration, creativity, communication, teamwork, etc.?			
Answers	Yes, I agree	Yes, partially agree	No. I disagree
Results	10 (41.66%)	13 (54.16%)	1 (4.16%)
12. Do you think that students who are usually passive on classes can be encouraged to be more active with additional aids as micro:bit?			
Answers	Yes, always	Yes, depends on the type of the unit, or the given task	No, the passive students are passive
Results	6 (25%)	15 (62.5%)	3 (12.5%)
13. Do you think that you will need more time for preparation if you want to use the Micro:bit in your class?			
Answers	Yes, always independently of the lesson	Yes, but depends on the lesson	No
Results	10 (41.7%)	14 (58.3%)	/
14. Do you think that in general there will be benefits from using Micro:bit as additional aids in the educational process			
Answers	Yes	Yes, but not particularly	No
Results	10 (41.66%)	10 (41.66%)	4 (16.66%)
15. Would you like to recommend the Micro:bit to your colleagues?			
Answers	Yes, very often	Yes, sometime	No
Results	8 (33.33%)	15 (62.5%)	1 (4.16%)

According to the results from Table II, there is mostly a positive opinion for the need of innovative approach, but availability of the computers or educational aids leads to limitations. As it can be seen from the results in Table III there is a divided opinion which goes in favor of Micro:bit and its benefits. The results lead to the general conclusion that use of such educational aids has a great potential to improve the educational process.

## V. CONCLUSIONS

In this paper, a general description is given of educational hardware aids as SBC. An analysis has been made on the advantages and disadvantages of all mentioned SBCs. We discussed the benefits from it and the improvements that it can apply on the educational process.

A questionnaire was carried out to assess teachers' opinion concerning the possible use of Micro:bit in the education process. The questionnaire results give a general picture of the opinion of the teachers concerning the benefits and positive practices of the use of educational aids like Micro:bit.

## REFERENCES

- [1] ArduBlock Home Page, <http://blog.ardublock.com/>. Last accessed 16 October 2021.
- [2] Arduino Home Page, <https://www.arduino.cc/>. Last accessed 20 September 2021.
- [3] Atmel Corporation Home Page, <https://www.microchip.com/>. Last accessed 21 September 2021.
- [4] BBC Home Page, <https://www.bbc.com/>. Last accessed 23 September 2021.
- [5] Brock, J. Dean, Rebecca F. Bruce, and Susan L. Reiser. "Using Arduino for introductory programming courses." *Journal of Computing Sciences in Colleges* 25.2 (2009): 129-130.
- [6] Calliope mini Home Page, <https://calliope.cc/>. Last accessed 20 September 2021.
- [7] EduKits Home Page, <https://edukits.co/>. Last accessed 16 October 2021.
- [8] Micro:bit Home Page, <https://microbit.org/>. Last accessed 20 September 2021.
- [9] MicroPython Home Page, <https://micropython.org/>. Last accessed 28 September 2021.
- [10] Microsoft MakeCode Home Page, <https://makecode.microbit.org/>. Last accessed 20 September 2021.
- [11] Online Course - Micro:bit Basics for Teachers, <https://microbit.britishcouncil.org/>. Last accessed 8 October 2021.
- [12] Open Roberta Home Page, <https://www.open-roberta.org/>. Last accessed 28 September 2021.
- [13] Ortmeyer, C.: Then and now: a brief history of Single Board Computers. *Electronic Design Uncovered*, 6, 1-11(2014).
- [14] Program "21<sup>st</sup> Century Schools" Home Page, <https://www.britishcouncil.mk/en/programmes/education/21st-century-schools>. Last accessed 8 October 2021.
- [15] Scratch Home Page, <https://scratch.mit.edu/>. Last accessed 28 September 2021.
- [16] Swift Playgrounds, Apple Store, <https://apps.apple.com/de/app/swift-playgrounds/id908519492>. Last accessed 28 September 2021.

# Locus of Control in the Function of Students' Academic Success

M. Kavalić\*, M. Pečujlija\*\*, S. Stanisavljev\*\*\*, D. Milosavljev\*\*\*, M. Gaborov\*\*\*, M. Bakator\*\*\*

\*PhD student, University of Novi Sad, Faculty of Technical Science, Novi Sad, Serbia

\*\* University of Novi Sad, Faculty of Technical Science, Novi Sad, Serbia

\*\*\* University of Novi Sad, Technical Faculty “Mihajlo Pupin”, Zrenjanin, Serbia  
e-mail: mihaljbakator@gmail.com

**Abstract - This paper aims to analyze the importance of locus of control, as a psychological construct in students. It is emphasized that locus of control creates the behavior of students and thus influences their academic achievements. This paper, based on previous research, shows that students who have an internal locus of control are more responsible, motivated, more satisfied and have better success. In contrast, students who have an external locus of control achieve a poorer academic performance, which is accompanied by stress, lack of motivation and creativity. Therefore, the importance of students' approach to their locus of control is emphasized.**

have an internal locus of control, are more resistant to negative events, are more satisfied, are not prone to experiencing stress, which results in better achievement during schooling. While people with an external locus of control are more prone to dissatisfaction, stress, and constant mood swings accompanied by a lack of motivation and responsibility which ultimately results in poor performance in tasks during schooling [19; 20; 21; 22; 23; 24; 25; 26; 27; 28; 29; 30).

## I. INTRODUCTION

The student population represents the future workforce, so it is very important to direct them in the right way in relation to their locus of control. Vijayashree and Jagdishchandra (2011) explain locus of control as a personality variable that assigns individuals according to the degree to which they accept personal responsibility for what happens to them and this is called internal locus of control, as opposed to attributing responsibility to forces beyond their control which is noted as an external locus [1]. Students' approach to their locus of control is important, as it indicates how they will behave as employees in the future. Locus of control is closely related to the functions and actions of individuals, and as such, it is observed as a personality variable that defines school achievement. Understanding the effects of locus of control and taking adequate actions towards a certain direction, leads to more efficient schooling.

It is very important to approach students according to their locus of control, therefore locus of teacher control has a very big role [2; 3; 4]. The locus of control of students directly affects the experience they have during schooling, which includes academic achievement, life and school satisfaction, relationships with teachers and other students [5; 6; 7; 8; 9; 10; 11; 12; 13; 14; 15; 16; 17; 18]. Furthermore, research shows that students, who

## II. RESEARCH METHODOLOGY

### A. Research subject and problem

The teacher-student relationship imposes various problems. Often misunderstandings can be a problem that later results in a poor student outcome. Therefore, it is necessary to approach students correctly, to find the appropriate motivational technique. The subject of the research is the analysis of locus of control as a psychological construct, which can serve as an indicator of the characteristics and behavior of students, on the basis of which an appropriate approach to students can be created.

### B. Research questions

Based on the subjects and research problems, the following research questions are noted:

IP1: Does locus of control affect the teacher-student relationship?

IP2: Is locus of control a predictor of academic achievement?

IP2: Does locus of control play a role in the social engagement of students?

### C. Research goal

The aim of this theoretical research is to understand the significance of students' locus of control of during schooling, based on previous empirical research.

### III. THEORETICAL FRAMEWORK

#### A. *Significance of locus of control in the teacher - student (IP1) relation*

A teacher's job is not only to transfer certain knowledge, but also to make the approach to students pedagogically oriented. The results of one study show that the effect of locus of control contributed to student life satisfaction [5]. Therefore, it is necessary for teachers during the interaction with students to work on raising satisfaction, both towards a certain task (schooling) and towards life.

When educating students, it is important to approach teachers based on their locus of control. According to Cook, L. D. (2019), the teacher control locus is an important factor in determining classroom-learning outcomes. With the right approach to students' locus of control by teachers, they can improve their productivity, and alleviate the negative feelings that occur during schooling. Teachers in urban schools experience significant stressors that can affect their efficiency, well-being, retention, and ability to meet the needs of their students [2]. The results of one study [3], indicate that teachers are most likely to feel unable to solve the situation and solve the problem, and that the personal locus of control has a key influence on this [4].

#### B. *The significance of locus control type on student academic achievement (IP2)*

The internal locus of control results in better academic adjustment and better performance, while external locus of control results in lower academic success. Students with a dominant internal locus of control find it easier to change their behavior, regardless of whether that behavior was supported positively or negatively, while students with an external locus of control find it harder to change their behavior [23]. Based on theoretical concepts [8; 9; 10; 11], and research results, which speak in favor of differences in values and locus of control between different educational youth and professional orientations, as well as gender differences [12; 13; 14; 15; 16; 17]. It was noted that there is a connection between value orientations and loci of control, as well as that students of different genders and from different faculties differ in preferred life values and the degree of possession of internal locus of control [18]. Students who have expressed a desire to start their own business in the future have a higher level of internal locus of control [31].

Lefcourt, Martin, and Seleh (1984) examined the behavior of students with more pronounced indicators of internal and external locus of control and found that students with internal locus of control had fewer consequences of some negative events from the past compared to students with external locus of control [19]. In relation to the students' locus of control, the experience of stress during schooling can also be predicted [6]. Students with an external locus of control are more likely to develop mood swings compared to students with an internal locus of control, and are more stressed, and are often dissatisfied [20]. Galluch, P. S., & Miller-Serrano, M. (2018), argued that the fear of negative evaluation is the underlying cause of stress, while social desirability leads to a person experiencing stress but not feeling it. It is emphasized that internal locus of control has a positive effect on performance, and that excessive stress leads to reduced performance. Also, the intensity of engagement in learning is more pronounced in people with internal locus of control [21].

The difference in the academic achievement of students with internal and external locus of control was also investigated by Kader, A. (2014). The locus of control has proven to be a significant predictor of academic achievement and success [7]. Strickland, (1988, according to Hewes & Hillman, 2001) states that individuals who have internal locus of control adapt better to the environment and achieve better academic success [32]. This is followed by Bender (1995), who believes that external locus of control causes a lack of motivation to learn and continuous failure, despite continuous attempts to solve school tasks [22].

#### C. *The role of locus of control in social engagement (IP3)*

According to Tomašević A.N. et al. (2021) there is a high positive relationship between internal locus of control and social engagement, i.e. there is a connection between an engaged approach to online teaching and accepting students' responsibility for their own lives. The research also showed that there are differences in responses by groups, showed that there are no statistically significant differences in the level of internal locus of control in students of different sexes, in students attending different student programs, and in students attending different years of study [24]. This is followed by other research, where Vrban, K. (2020) indicates that students with an internal locus of control are perceived as creative people, and that the determinants of creativity positively affect their

entrepreneurial intentions [25]. Abdalla, MMI, et al., (2019), found a significant predictive effect of problem-based learning (PBL) acceptance on academic self-concept (ASC) and internal locus of control (ILOC) [26].

This is followed by Baković, M. (2020), who says that students with high subjective well-being have high self-efficacy, are essentially motivated, and have internal locus of control. Students who have a lower level of motivation than others and a higher level of self-efficacy and intrinsic motivation achieve higher academic achievement. Furthermore, motivation and the external locus of control are in a negative relationship, and self-efficacy and internal locus of control are positive predictors of subjective well-being [27].

It is very important to look at students as adolescents with problems that are characteristic of that age. In a research dealing with adolescent risk behavior, locus of control is used as a predictor defined as an assessment of belief in the possibility of controlling events, both in the external environment and in terms of internal events [28]. Several studies [28;29], on the topic of risky behaviors indicate that adolescents with risky behavior are characterized by an external locus of control, while their peers without risky behavior are characterized by an internal locus of control. Strong internal locus of control has a protective potential in relation to the use of light and heavy drugs, as well as alcohol, but there is no probability that the same outcome will be realized in the case of gambling / betting [30].

#### *D. Summary of previous empirical studies on students' locus of control*

Previous research has included a large number of studies that study the effects of locus of control type of the student population. Table 1 presents a summary of the outcomes of previous empirical studies.

TABLE 1. SUMMARY OF PREVIOUS EMPIRICAL STUDIES ON THE IMPORTANCE OF LOCUS OF CONTROL DURING SCHOOLING

Authors	Effects of locus of control
Karaman, M.A., et al. (2018)	An approach to locus of control contributes to student life satisfaction.
Strickland, (1988, according to Hewes & Hillman, 2001)	People with an internal locus of control adapt better in the environment and achieve better academic success.

Mueller & Thomas, (2001)	Students who have expressed a desire to start their own business in the future have a higher level of internal locus of control.
Bojović et al., (2015); Bouillet,(2004); Ilišin & Radin, (2002); Marić & Novović, (2010); Mamlin et al., (2001)	The type of locus of control affects the level of education and professional orientation.
Sakač, M. D., & Marić, M. R. (2019)	The type of locus of control determines value orientations and life values.
Bender (1995)	People with an external locus of control are more likely to fail, and lack motivation to learn.
Cook, L.D. (2019)	Teacher's locus of control is an important factor in determining classroom learning outcomes.
Lefkort, et al. (1984)	Students with an internal locus of control cope better with negative events and situations.
Helmbrecht, B., & Ayars, C. (2021)	In relation to students' locus of control, the experience of stress during schooling can be predicted.
Au, E.W. (2015)	Students with an external locus of control are more likely to develop mood swings, are more stressed, and are often dissatisfied.
Kader, A. (2014)	Locus of control has proven to be a significant predictor of academic achievement and success.  The internal locus of control results in better academic adjustment and better performance, while the external locus of control results in lower academic success.
Kutanis, R. Ö., et al. (2011)	Students with a dominant internal locus of control find it easier to change their behavior.

Tomašević A.N. et al. (2021)	There is a high positive relationship between the internal locus of control and social engagement, i.e. there is a connection between an engaged approach to teaching and an acceptance of responsibility for one's own life.		incompetence, positivity and confusion.
Vrban, K. (2020)	Students with an internal locus of control are perceived as creative individuals.	Galluch, P. S., & Miller-Serrano, M. (2018)	Internal locus of control has a positive effect on performance and the elimination of stress.
Baković, M. (2020)	Students who have an internal locus of control are essentially motivated, with high subjective well-being, and achieve greater academic achievement.	Cahyadi, A., Hendryadi, H., & Mappadang, A. (2021)	The intensity of engagement in learning is more pronounced in people with internal locus of control.
Marković, et al. (2011)	Locus of control is used as a predictor defined as an assessment of belief in the possibility of controlling events, both in the external environment and in terms of internal events.	IV. CONCLUSION	
Gudjonsson, Sigurdsson, (2004)	Students (Adolescents) with risky behavior are characterized by an external locus of control, while their peers without risky behavior are characterized by an internal locus of control.	Based on the presented results of previously conducted studies, it can be concluded that locus of control as a psychological construct of personality is a predictor for student action during schooling. Therefore, it can be said that locus of control can be a significant indicator of academic success, as well as socio-social integration into the school environment. Based on defining the type of locus of control, an adequate approach can be created that will influence students to direct their behavior to the highest quality content and a better future.	
Janković, U. (2021)	Strong internal locus of control has a protective potential in relation to the use of light and heavy drugs, as well as alcohol in young people.	REFERENCES	
Jagdischchandra i Vijayashree (2011)	Locus of control is a personality variable that assigns individuals according to the degree to which they accept personal responsibility for what happens to them.	<p>[1] Vijayashree, L., &amp; Jagdischchandra, M. V. (2011). Locus of control and job satisfaction: PSU employees. <i>Serbian Journal of Management</i>, 6(2), 193-203.</p> <p>[2] Cook, L. D. (2019). Teacher's Locus of Control Scale: Test Characteristics and New Directions. <i>Caribbean Journal of Psychology</i>, 11(1), 78–105.</p> <p>[3] Camacho, D. A., Vera, E., Scardamalia, K., &amp; Phalen, P. L. (2018). What are urban teachers thinking and feeling? <i>Psychology in the Schools</i>, 55(9), 1133–1150. <a href="https://doi.org/10.1002/pits.22176">https://doi.org/10.1002/pits.22176</a></p> <p>[4] Cahyadi, A., Hendryadi, H., &amp; Mappadang, A. (2021). Workplace and classroom incivility and learning engagement: the moderating role of locus of control. <i>International Journal for Educational Integrity</i>, 17(1), 1–17.</p> <p>[5] Karaman, M. A., Nelson, K. M., &amp; Cavazos Vela, J. (2018). The mediation effects of achievement motivation and locus of control between academic stress and life satisfaction in undergraduate students. <i>British Journal of Guidance &amp; Counselling</i>, 46(4), 375–384. <a href="https://doi.org/10.1080/03069885.2017.1346233">https://doi.org/10.1080/03069885.2017.1346233</a></p> <p>[6] Helmbrecht, B., &amp; Ayars, C. (2021). Predictors of Stress in First-Generation College Students. <i>Journal of Student Affairs Research &amp; Practice</i>, 58(2), 214–226.</p> <p>[7] Kader, A. (2014). Locus of Control, Student Motivation, and Achievement in Principles of Microeconomics, <i>American International Journal of Contemporary Research</i>, 4(9), 1-11.</p> <p>[8] Roccas, S., Sagiv, L., Schwartz, S.H., Knafo, A. (2002) The big five personality factors and personal values. <i>Personality and Social Psychology Bulletin</i>, 28(6), 789-801</p> <p>[9] Schwartz, H.S. (2006) Basic human values: Theory, measurement, and applications. <i>Revue Francaise de Sociologie</i>, 47(4), 244-288</p>	
Camacho, et al., (2018)	Teachers' personal locus of control, with an emphasis on external locus, indicate that employees are most likely to feel unable to solve the situation and solve problems, and the most common feelings that appear are anger, anxiety, sadness, emotional exhaustion,		



- [10] Seligman, M. (1975) Helplessness: On depression, development and death. San Francisco: W. H. Freeman
- [11] Taylor, A.A., Macdonald, D.A. (1999) Religion and the five factor model of personality: An exploratory investigation using a Canadian university sample. *Personality and Individual Differences*, 27(6), 1243-1259
- [12] Bojović, Ž., Vasiljević, D., Sudžilovski, D. (2015) Values and value orientations of students, future primary school teachers and preschool teachers. *Croatian Journal of Education*, 17(4), 11-35
- [13] Bouillet, D. (2004) The relation of young people to the values and factors of family life. *Sociologija sela*, 163-164(1-2), 173-194
- [14] Ilišin, V., & Radin, F. (2002). Društveni kontekst i metodologija istraživanja. *Mladi uoči trećeg milenija*, 356, 13.
- [15] Marić, M., Novović, Z. (2010) Factors that contribute dysphoric reactions in adolescence. *Pedagoška stvarnost*, 56(3-4), 317-325
- [16] Mamlin, N., Harris, K. R., & Case, L. P. (2001). A methodological analysis of research on locus of control and learning disabilities: Rethinking a common assumption. *The Journal of Special Education*, 34(4), 214-225.
- [17] Popadić, D. (1986) *Locus control and attribution as an approach to the interpretation of the cause of achievement*. Beograd: Univerzitet u Beogradu - Filozofski fakultet, *Magister's thesis Psychological Bulletin*, 65(4), 206-20.
- [18] Sakač, M. D., & Marić, M. R. (2019). Vrednosni sistem i lokus kontrole kod studenata. *Sociološki pregled*, 53(1), 136-159.
- [19] Lefcourt, H. M., Martin, R. A., & Saleh, W. E. (1984). Locus of control and social support: Interactive moderators of stress. *Journal of Personality and Social Psychology*, 47(2), 378.
- [20] Au, E. W. (2015). Locus of control, self-efficacy, and the mediating effect of outcome control: Predicting course-level and global outcomes in an academic context. *Anxiety, Stress, & Coping*, 28(4), 425-444.
- [21] Galluch, P. S., & Miller-Serrano, M. (2018). The Truth About Predispositions: Exposing The Gap Between What We Say and How We Feel. *Journal of Strategic Innovation & Sustainability*, 13(2), 37-53.  
<https://doi.org/10.33423/jsis.v13i2.605>
- [22] Bender, W.N. (1995) Learning disabilities: characteristics, identification and teaching strategies. *Needham Heights, Mass: Allyn & Bacon*, 2nd ed
- [23] Kutanis, R. Ö., Mesci, M., & Övdür, Z. (2011). The Effects of Locus of Control on Learning Performance: A Case of an Academic Organization. *Journal of Economic & Social Studies (JECOSS)*, 1(2), 113-133.
- [24] Tomašević, A. N., Jokanović, B., & Zubanov, V. (2021). Socijalni aspekti online nastave: angažovanje studenata u nastavnom procesu. *XXVII Skup Trendovi razvoja: "On-line nastava na Univerzitetima"* Paper No.T1.3-6 03733, 169-172.
- [25] Vrban, K. (2020). Utjecaj kreativnosti i lokusa kontrole na poduzetničke namjere studenata Ekonomskog fakulteta u Rijeci (Doctoral dissertation, University of Rijeka. Faculty of Economics and Business).
- [26] Abdalla, M. M. I., Abdelal, M. S., & Siew Choo Soon. (2019). Attitude towards problem-based learning and its relationship with locus of control and academic self-concept among medical students. *Korean Journal of Medical Education*, 31(1), 11-18.
- [27] Baković, M. (2020). *Motivacija, samoeфикаsnost i lokus kontrole kao prediktori akademskog postignuća i dobroti studenata* (Doctoral dissertation, University of Zagreb. Faculty of Croatian Studies. Department of Psychology).
- [28] Marković, J., Srdanović-Maraš, J., Šobot, V., Ivanović-Kovačević, S., & Martinović-Mitrović, S. (2011). Neke psihološke karakteristike kao protektivni, odnosno rizični faktori za pojavu poremećaja ponašanja. *Psihologija*, 44(2), 167-185.
- [29] Gudjonsson, G. H., & Sigurdsson, J. F. (2004). Motivation for offending and personality. *Legal and Criminological Psychology*, 9(1), 69-81.
- [30] Janković, U. (2021). Assertiveness, self-esteem and parental influence (fathers) as factors in high-risk behavior of high school students: The case of Montenegro. *Sociologija*, 63(1), 50-71.
- [31] Mueller, S.L., & Thomas, A.S. (2001). Culture and entrepreneurial potential: A nine country study of locus of control and innovativeness. *Journal of Business Venturing*, 16(1), 51-75.
- [32] Hewes, D.W., Hailman, W.N. (2001) Vrednosne orijentacije adolescenata - vrednosti i kontekst. *Grand Rapids: Defender of Froebel, Froebel Foundation USA*, 31(4), 343-364

# Discussion Thread on Google Classroom and Group Communication: A Case Study of Language Center Students

B. Saliu\*

\*Language Center-SEEU  
b.saliu@seeu.edu.mk

**Abstract** - With the start of the pandemic, group communication is transferred online. Google Classroom serves as communication center for students of Southeast European University who study together to spread information from one another for a particular task. This research uses qualitative content analysis to determine whether discussion forums on Google Classroom could be viewed as group communication in the usual academic explanation of the term. And the usual academic explanation of group communication is that it comprises of five main features: size, interdependence, task, norms and identity. The findings suggest that online discussion forums have all five features of face-to-face group work – size, interdependence, assignment, individuality, and norms. The study concludes that though online forums bring in limitations to interactions, discussion forums can indeed be viewed as group communication. These findings should help teachers plan for and deal with the difficulty of communication between group members in Google Classroom.

## I. INTRODUCTION

Discussion thread is grouping together all comments or discussion on the same topic or it can be defined as one topic under discussion by a group of people, in this case students. And group communication means interaction of three or more individuals to accomplish a certain task (e.g., Rothwell, 2013), and it is generally supposed that people can achieve more by working in groups with others than they can by working on their own. In the digital age, group interactions has started to drift online. Groups collaborate through email, discussion forums, and are generally using Internet tools such as Google Classroom that allow working on their group projects remotely. Online support groups are appreciated by individuals in need of compassion (Turner, Grube, and Meyers, 2001). Participation, context, timing, and structure of interaction in Google classroom are automatically recorded, providing rich group interaction data for researchers.

Though online group communication appears favorable to all those participating, scholars noted

several deficiencies of web interactions for teams, such as poor relational development (e.g., Galston, 2000; Straus, 1999) and excessive group size (Jones, Ravid, and Rafaeli, 2004) that could lead to poor group cohesion (Rice, 1987). Thus, it is important to understand how modern online communities function and whether interaction between people in such format can qualify as group communication in its traditional understanding and fully substitute face to-face group interactions. This study focuses on Google Classroom group communication, a prominent example of an online user forum at South East European University. It is a technical support community that is hosted by the Google, but with content created exclusively by its users, learners and students in this situation. The study analyzed what features of group communication these discussion threads had and whether they could be seen as similar to face-to face group work.

## II. LITERATURE REVIEW

Communication and group communication in learning is a process of transforming messages in the form of science and technology from educators to students, where students are able to understand the purpose of the message in accordance with predetermined objectives, thereby increasing the insight of science and technology and cause behavior change for the better.(Subandi, 2018; Choirudin 2018). In addition to that, Subandi(2018) explains also that teachers are the party most responsible for the ongoing effective communication in learning, so that lecturers as teachers are required to have good communication skills in order to produce an effective learning process.

While face-to-face group communication is commonly defined as three or more people working interdependently for the purpose of accomplishing a task (e.g., Myers and Anderson, 2008, Rothwell,

2013), online communities are often larger networks of people who gather around a common purpose or activity and use computer-mediated communication as their primary means of interaction (Baym, 2000; Rheingold, 2000; Smith and Kollock, 1999). In order to explore how online interaction fits into the description of group communication, I analyzed how features of Google Classroom-mediated communication identified by scholars align with the core concepts of traditional face-to-face group communication. The literature review focuses on the five commonly accepted features of groups – size, interdependence, task, identity, and norms (Keyton and Beck, 2009).

#### *A. Group size and the impact of varying group size*

Group size is of an essential concern in discussion groups and many results and findings indicate that smaller groups establish and maintain higher levels of communication quality. Therefore, in terms of group size feature, the research shows that three or four, at the most five, is the optimal size of group communication, while there are exceptions, for the most part, and group size is often thought of in terms of 3-12 people.

Different from what many researchers support, online groups can be very large in size compared to traditional face-to-face groups Black et al., 2011; Huffaker, 2011; Rice, 1987). Jones, Ravid, and Rafaeli (2004) found that the larger the online group was, the fewer messages were exchanged between members and they were shorter. Huffaker (2011), on the contrary, argued that group size positively impacted communication activity and shared language, but agreed to previous findings which showed that the more discussion participants there were in online groups, the more likely information overload and lack of group cohesion might occur (Rice, 1987). In this context, Burgeon and Bonito (2002) spoke of the group discussion quality also, and they defined it, so that it is the group members 'evaluation of the level of effectiveness and satisfaction experienced during group discussion and high quality group discussion that generate multiple perspective, where shared knowledge allows members to understand the problem. The size of online groups affected group stability and quality, contributing to both acquisition of new members and loss of older ones (Butler, 2001). Thus, the large number of individuals involved in computer-mediated interaction at the same time and on the same topic is usually viewed as a factor hindering group communication experience. Despite the large size of online groups, few participants are still active contributors to community interaction and

contribute more valuable information than others and engage social as well as practical communication to keep community interactions going (Howison, Inoue, and Crowston, 2006).

#### *B. Member Interdependence in Google Classroom*

Group members are mutually dependent in that the behavior of one group member affects both relational and task behaviors of other group members (Myers and Anderson, 2008). Despite the fact that online groups can be large in size, researchers argue that learners in them still perceive that what helps one member in a group helps all members in the group, and what hurts one member in a group hurts all members in the group. Johnson (1998) presented the concept of interdependence, more referred to as positive interdependence, by stating that the success of one person is dependent on the success of the group. All members should rely on one another to achieve the goal and need to believe that they are linked together to succeed. In relation to this, Heinz and Rice (2009) found that the more group members communicated online, the stronger were their relational ties. Despite the fact that some researchers disputed that the group member relationship could be well maintained via computer-mediated communication, others consider that on line communication made relational development difficult and even impossible. They consider that CMC lacks social context, physical environment and members nonverbal behaviors, gestures, that characterize the nature of the social situation. But still, although CMC is supposed to be low in social presence, online users in Google classroom have over time learned to adapt to the new environment and use textual messages for communicating, users could transmit nonverbal cues through text by filling messages with verbal, grammatical features anticipated to reproduce face to face oral communication.

#### *C. Task*

Task groups are groups of learners or individuals brought together to accomplish a specific action or produce a product. Our students in Google Classroom have participated in an educational setting where they have already experienced a task group in action. Therefore group members are interdependent and manage their efforts to accomplish a common task, which is the purpose of the group's existence (Myers and Anderson, 2008). Different research has shown that when group problem solving is computer mediated, respectively on online platforms, communications become more task oriented with clearer role expectations, while face-to-face communications are more cohesive and

personal. In relation to this, Li (2007) found that face-to-face groups perform better than computer-mediated groups in problem analysis and criteria establishment and on line communication groups, on the other hand, are less efficient than face-to-face groups in terms of communication effectiveness. While they used double the time to complete their tasks, they only produced half of the communication messages that their face-to-face peers produced. At the same time, although face-to-face groups performed communication functions better, they did not necessarily have better group outcomes than on line groups. Furthermore, Walther (1992) argued that computer-mediated communication was more efficient in performing tasks than traditional group work due to its lack of unnecessary emphatic and emotional cues. Whether online groups are an efficient means for solving tasks depends, then, on the type of the specific task and characteristics of the group. Generally group members are more motivated to help each other when cohesion is high and task oriented (high exam performance) has been an example of this.

#### D. Group norms

Group norms are crucial rules that can support a group to work efficiently and discourage behaviors that deter its value. Even though unwritten, they govern how group members interact with each other, work as a team and make decisions. Myers and Anderson (2008) characterize them as one of the secondary group features and a group norm is perceived as a rule that groups adopt to regulate members' behavior (Bonney, 1974; Feldman, 1984). Active group members establish and legitimize certain group patterns that may eventually become norms (Bettenhausen and Murnighan, 1985). Norm violation can cause sanctions to be imposed on group members (Shaw, 1981). Different online communities appear to feature a variety of norms specific to their field of study. However, relatively only a little computer mediated communication literature touched upon the topic of group norms. This may be due to the diversity of online community types and the appearance of new ones over the past few years. Early studies of computer mediated communication made a general assumption that norms in computer-mediated communication developed over time and helped to mediate online relationships between group members (Walther and Burgoon, 1992). Likewise, Black, Wesler, Cosley, and DeGroot (2011) argued that the establishment of group norms should govern online group members' behavior. Such governance processes are important as they help to coordinate

communication of members who may be physically detached or have different expectations about group work. This study investigates whether norms of an online forum were closely followed by members and whether members in select threads came up with norms of their own.

#### E. Group Identity

Group identity refers to a person's sense of belonging to a particular group. Generally, computer-mediated groups can take longer time to communicate than face-to-face groups, and as a result it also takes longer for them to come up with a shared group identity (Walther,1992). Google classroom learners tend to form a shared identity in discussing topics of common interest and use shared language and talking about items using the same word choices. The five features of group work described in this study seem to be present in users' interactions on Google Classroom discussion forums and in order to explore the specific characteristic of online interactions on Google Classroom, this study tried to answer the following research question: *Can learner interaction on Google Classroom be described as a group work?*

### III. METHOD

To gather data that would serve to answer the research question, a qualitative content analysis of information-rich discussion threads from different sections of the Google classroom was carried out. Based on the assumption that interaction between users within one thread might be seen as group communication, a forum thread composed of posts made by individual forum users served as the component of analysis. I studied several discussion threads and employed determined criterion-based sampling to select 10 information-rich cases based on three criteria. First, the thread had to be marked as "resolved" by users. Second, I looked for threads where three or more users were engaged in a discussion. Finally, I selected threads that had a sufficient number of posts and information in them to be considered a discussion rather than a question and an immediate answer to it. The time frame for the study was from March 22nd, 2020 to May 15th, 2020. This time period is explained by the fact that while most of the analyzed threads were active for a relatively short period of time (e.g., a week), two of the analyzed discussion threads stayed active for almost a year, and information in both of them was relevant for the study. In order to determine the size of the possible online group, I counted the number of active users in the thread. I measured a user to be actively involved in the discussion if there were

three or more posts from him or her. I categorized some of the analyzed discussion topics as normal, as people in them were discussing everyday issues and concerns, such as poor air quality or slow economic development. Other threads discuss more specialized and practical issues. I used assessment to categorize users' communication in the threads as relational or task. Thus, I analyzed textual information from discussion threads that related to the studied online group communication features (member interdependence, group identity, task, and norms) and then compared the results to those in the existing literature. I also conduct online interviews of several active students who were discussion forum users in order to get an inside perspective at the discussions. I asked questions concerning relational and task communication in forum threads, as well as regarding perceptions of group work in general. Bringing together interviews with textual data analysis allowed for some data triangulation and certainly affected the credibility and validity of study outcomes.

#### IV. RESULTS

All of the learners share the characteristics of being owners of Google classroom profile. Every Google classroom learner can become a member by registering on Google classroom with their ID. School interactions are conducted through textual messages and take the form of threads. Users create multiple new threads every day searching about issues they have with their onsite classes. The discussion forums include a status system that allows students to thank helpful colleagues by "liking" their posts, marking posts as useful, or indicating that a specific post helped to resolve the issue discussed in the thread. Accordingly, students get points by posting helpful responses – five points for useful responses and 10 for the one that helped to resolve the issue. The more points a user has, the higher their rank (from first to sixth) and the more privileges they have. Users can also specify that they have the same issue as the topic starter by clicking the "I have this question too" key. However, as the observations showed, this feature was not used by many users. On the contrary, most users appeared to ask questions that had already been asked before. This is a violation of the Google classroom's ethics norm, as users are expected to first try to search for an answer and only after that ask a new question. This to some extent explains why interaction in the mainstream threads comes down to one or two answers from other class members, which is enough to solve the issue. Such threads cannot meet the requirements as group

interaction as only two users are involved, and they do not communicate information sufficient for analysis. Other interactions, however, extended over several months and occurred between many users, which generated some rich data on member interdependence, identity, and specific norms within each of the online class interactions.

#### V. DISCUSSION AND CONCLUSION

The purpose of this study was to find out if a discussion thread on Google classroom discussion forums could be viewed as group communication. Outcomes of textual analysis of Google Classroom threads showed that five features of group work were to varying degrees present in users' interactions. The number of vigorous participants ranged from four to ten people. Learners depended on each other for information, and their communication established relational progress. For the most part, user communication was task-oriented and aimed at finding solutions to issues. Although there were exceptions, users in general tended to follow ethical and organizational norms of the discussion forum. Finally, members identified with each other on issues that mattered to them. At the same time, some of these features took forms that were different from those found in traditional face-to-face groups. Observation of comments illustrated that not all users who communicated in a thread shared the same identity, and sometimes users could split into two opposing camps within the same discussion, each with its own shared beliefs. Moreover, some users' posts did not show evidence of them identifying with anyone else. A discussion thread, then, cannot be viewed as group interaction in itself, as some discussion participants did not identify with others. Absence of a clear group task and an end result to user interaction in select discussions was another issue that made it difficult to view such forum threads as group work. Posts lacked task-related communication, and such threads appeared to be collective of user feedback rather than purposeful group discussions. At the same time, however, several discussion threads were rich on task-related communication and did have a clear outcome. Thus, an online forum interaction may or may not have an end result. It appears that threads settling on typical issues are less likely to have an end result, while threads that address specific technical problem are more likely to arrive at a definite conclusion. Further research is needed to confirm this assumption. Most significantly, only two of the analyzed discussion threads possessed five core features of group communication at the same time. While all 10 interactions had an

appropriate number of users involved, and at least one of these users was dependent on others for help, one or more of the three other important group features was missing. Users either did not demonstrate proof of shared identity, failed to follow norms, or did not have a clear group task that they worked to achieve. With these features absent, these threads cannot be viewed as group communication. While admitting the essentials and limitations that web forums introduce to the communication process (e.g., interactions can only be in order), I disagree that member interactions within these two discussion threads can be viewed as group communication. This study had certain limitations. Due to resource constraint, a fairly small number of discussion threads was selected by determined non-probability sampling methods and then analyzed. While qualitative content analysis helped to collect rich data, the findings cannot be generalized and applied to other threads or discussion forum websites. Quantitative research methods and random sampling would allow for a systematic analysis of a larger number of discussion threads and expand the applicability of findings. Another limitation was the lack of interviewee participants. The number of the interviewees should be increased to provide for better research power. For future studies, a regulations scheme can be created to determine whether specific patterns or words in textual interaction of members on web discussion forums point to member interdependency, group task, norms, or identity. Then, using quantitative research methods, it would be possible to test the hypothesis of whether the discussion topic influences the presence or absence of an end result in group interaction and communication.

## REFERENCES

- [1]. Burgoon, J. K., Bonito, J., Ramirez, A., Kam, K., Dunbar, N. E., & Fischer, J. (2002). Testing the interactivity principle: Effects of Mediation, Proximity, and verbal and nonverbal modalities in interpersonal interaction. *Journal of Communication*, 52(3), 657-
- [2]. Bonney, W. C. (1974). The maturation of groups. *Small Group Behavior*, 5, 445–461.
- [3]. Butler, B. S. (2001). Membership size, communication activity, and sustainability: A resource-based model of online social structures. *Information Systems Research*, 12, 346–362.
- [4]. Butler, B., Joyce, E., and Pike, J. (2008). Don't look now, but we've created a bureaucracy: The nature and roles of policies and rules in Wikipedia. *Proceedings of the twenty-sixth Annual SIGCHI Conference on Human Factors in Computing Systems* (pp. 1101-1110). New York, NY: Annual SIGCHI Conference on Human Factors in Computing Systems.
- [5]. Carey, J. (1980). Paralanguage in computer mediated communication. In N. K. Sondheimer (Ed.), *The 18th annual meeting of the association for computational linguistics and parasection on topics of interactive discourse: Proceedings of the conference* (pp. 67-69). Philadelphia, PA: University of Pennsylvania.
- [6]. Cramton, C. D. (2001). The mutual knowledge problem and its consequences for dispersed collaboration. *Organization Science*, 12, 346–371.
- [7]. Feldman, D. C. (1984). The development and enforcement of group norms. *Academy of Management Review*, 9, 47–53.
- [8]. Galston, W. A. (2000). Does the internet strengthen community? *National Civic Review*, 89, 193–202.
- [9]. Gruhl, D., Guha, R., Liben-Nowell, D., and Tomkins, A. (2004). Information diffusion through blogspace. *Proceedings of the 13th International Conference on the World Wide Web* (pp. 491–501). New York, NY: 13th International Conference on the World Wide Web.
- [10]. Gumpert, G., and Cathcart, R. (1986). *Interpersonal communication in a media world* (3rd ed.). New York, NY: Oxford University Press.
- [11]. Heinz, M., and Rice, R. E. (2009). An integrated model of knowledge sharing in contemporary communication environments. *Communication Yearbook*, 33, 134–175.
- [12]. Johnson, D.W., & Johnson, R.T. (1990). Using cooperative learning in math. In N., Davidson (ed.), *Cooperative Learning In Mathematics* (pp.103-125). Menlo Park, California, USA: Addison-Wesley Publishing
- [13]. Subandi, C Choirudin, (2018) Building Interactive Communication with Google Classroom, *International Journal of Engineering & Technology*

# Implementation of Drones in Teaching

D. Kreculj\*, M. Gaborov\*\*, N. Ratkovic Kovacevic\*\*\*,  
V. Nikolic\*\*\*\*, S. Minic\*\*\*\*\*, N. Cvorovic\*\*\*\*\*

\* Academy of Technical Applied Studies, Serbia, Belgrade

\*\* Technical Faculty „Mihajlo Pupin“, Serbia, Zrenjanin

\*\*\* Academy of Technical Applied Studies, Serbia, Belgrade

\*\*\*\*University of Criminal Investigation and Police Studies, Serbia, Belgrade

\*\*\*\*\* Teacher Education Faculty, Serbia, Leposavic

\*\*\*\*\*10th Belgrade Gymnasium, Belgrade, Serbia

kreculj7@gmail.com

**Abstract - Drones are used in a studying of specific technical areas through targeted courses are used. They present innovative and flexible teaching tools that are applicable in a multiple education fields. Usually they have not complex constructions, small in size and according to price affordable solution. Their increase implementations are the result of merging and interweaving several scientific fields, such as electricity, mechanical engineering, automatic control, computer programming, aviation etc. With drones in learning approaches, students will adopt and develop significant technological, cross-curricular and digital competencies. In parallel, they analyze parts of the mechatronic constructions and acquire the programming and control skills about drone flights. In this paper the main properties of the specific Ryze Tello drone model, suitable for a teaching processes in schools on different levels are described. It has been proven that drones can be applied from a theoretical and practical point of view in primary and secondary schools, but also in academies and universities. Then special up-to-date application DroneBlocks, for a quick and easy drone model control, in details is considered. The key facts about blocks of codes and line codes in well-known and often used programming language JavaScript, are also discussed. The designed codes for programming of drone flight mission controls have been deployed and presented too.**

## I. INTRODUCTION

Today there is an evident expansion in the production and then using of drones. These technical devices, are used for various purposes, ie. in the army, police, traffic, agricultural, education, commerce, science, media, etc. For educational purposes and teaching besides existing models new innovative ones are being continuously developed.

As many innovative technologies implemented into teaching curriculum, drones have potential to be another engaging method of integrating STEAM (Science, Technology, Engineering, Arts and Mathematics) in education. Innovatively oriented teachers are always looking for the new methods and approaches to engage students more in topics and provide meaningful lessons. Corresponding curriculums, which based on drones, show

significant promises through exciting and dynamic accesses to teach programming and related

technologies. Associated interactivity and modularity should be exceptionally motivating to students but also teachers. The program will be easy to implement and possibility for competitions take the students to a new level of active learning. Undoubtedly drones will be a new and exciting part of technological and engineering education for dynamically coming years.

Technology enhanced learning is an effective way to deliver appropriate and requested timely student education. With the advanced technologies in classrooms, the pedagogy method approaches in teaching must also change.

Drones are expected to be the main form of fast goods and reconnaissance delivery in a few following years. Thus they will be used in dangerous industrial processes, for testing damage and malfunctions, military and police purposes, precision guidance, auto-programmed flights, and similar.

There are many programs, trainings and workshops that offer robotics, automation and programming separately, but no current specific course, or curriculum sets, that offer united drone piloting, coding, problem solving and computational thinking at some schooling level. [1]

For certain drone models in project phase it is necessary to define their control systems. Such system must be adaptable, precise and easy to perform. The realization of the drone quality control implies the use of special devices, interfaces and applications via computers, or ubiquitous mobile phones.

## II. DRONES IN CLASSROOM

Drones as UAV (Unmanned Aircraft Vehicle) do not have a long tradition overall. However today

they are in intensive research, project and development processes and procedures. The education system must accept and consider such type of mini aircrafts, as a reliable multifunctional teaching tool as soon as possible. Recently they were introduced even even in primary schools in different countries.

In higher education drones from theoretical and practical point of view are studied. Students usually learn about construction, aerodynamics, engines, control, equipment, By allowing them to operate with drones, educators can inspire students to learn about local geography, cartography and the local history of their communities.

Teachers usually are using drones for the following reasons:

- Drones are powerful math teaching tools,
- Provide a frame to teach STEAM related topics,
- Can help students develop soft skills,
- Conduce a frame to teach STEAM subjects. [2]

Students can study operation states and create simulation drone models to discover and remove process inefficiencies. Availability of modern technologies in teaching STEAM subjects with block coding and drones in a quality and high level has resulted. There is a constant aspiration that some new teaching tools are appearing during the time.

Drones can be equipped with various sensors to be as safe and efficient as possible. Some drones have a distance sensor on all six sides to try to avoid existing obstacles. Yet the most common sensor on drones is the gyroscope. It helps the drone pilot to maintain a stable flight, and will dose the thrust on each of the four propellers to keep it as still as possible during flight. In order for pilots to get the maximum power during the flight, they need excellent knowledge of aerodynamics, as well as the ability to react quickly if it would be needed. [2]

Specific university courses can greatly benefit by introduction and considerations drone properties. They can be used for the realization of teaching units in many inventive ways. Students from various engineering discipline, but even from journalism, pharmacy, archeology, have started using this inventive technology to enhance their professional training, and to add real-world examples to their studies activities. The prominent example of simple school drone in figure 1 is presented.

While it may sound obviously, students from different engineering fields, including electronic and

aeronautical engineering, are greatly benefiting from drones, as they allow them to build and test concepts at very low operation costs. Besides they try out and examine drones on real life environments and conditions. Surely drones can be very powerful learning tools for practices as nowadays as in the future. However, unlike other technological innovations which are often developed, or brought to market by entrepreneurs, there are some teachers which are finding new uses and applications that can truly unveil their teaching potential. [3]



Figure 1. Drone for the classroom

When students make constructive modifications and fly their own drones, they learn about automatics, electricity, computer programming, aviation, project management, physics at once. In general, technical and vocational education prepares students for work in a specific conditions and it is rooted in apprenticeship and hands-on learning and authentic working environments.

There are real-world things and amazing technologies that are learning since primary school. It is expected that through high school drone technology will be integrated across a lot of different educational programs in the coming years.

Drones, as a category of UAVs, are becoming increasingly affordable because of different reasons. With decent entry-level models that are available for nearly \$100, to the model equipped with high-definition cameras costing about \$1000. Drones are powered by much of the same tech that powers phones. Both drones and smart phones are part of the Internet of Things (IoT), and they collect and share data with other connected objects (devices) from the environment (figure 1).

There are two areas where drones could show a major leap in use. The first is interdisciplinary project-based learning and examples of those projects are drones for school lessons. This is an interdisciplinary program that was developed at certain universities by today. In this program content, students assume the role of engineers and actually design drones. The second is the process of



creating drones that involves many different STEAM teaching concepts from a large number of different science disciplines.

Teachers working at the technical vocational schools, consider drones from different perspectives (options). One is that drones have many real-world applications and the ability to operate drones will be an asset in many industries. While other is that vocational education program typically includes work experience, apprenticeship, and there are certain opportunities for students to use drones for learning the real-world applications. Many schools have broadcast media programs. Students in these programs could use drones to create media productions for real needs, wishes and audiences. Drones will have a very large impact on a overall student learning and much designed activities will be occurred outside of the classrooms. Also they are going to play an increasingly important role in economy and reasonable opportunities are using drones to engage students through authentic place-based learning experiences. [4]

### III. THE RYZE TELLO DRONE

The Rize Tello drone is known as the TLW004 and is a product of Ryze Tech company. It is made in a combination of plastic and cardboard materials. The mass of this drone is only 80g, including the battery, while its dimensions are 98×92.5×41mm, and it belongs to the category of smaller drones.

The Tello drone is made up of several construction elements (figure 2). It has a main beam, propeller holder on which electrical motors that drive 4 propellers (diameter of 3 inches) are attached, and security arches that protect them. On the side there is a button to turn on the device and a microUSB port, while on the front exist camera. Inside them Intel 14-core processor is, which powers the device, as well as a removable 1100mAh battery (3,8V) located on the bottom. [5]



Figure 2. Ryze Tello drone [5]

The drone has a built-in distance detection function, known as the Range Finder, while signals are in charge of 2,4GHz Wi-Fi according to the 802.11n standard. It contains barometer, LED and Vision system, so that the device can be undisturbed

used even at night conditions. Since it is a drone intended for fun and learning, the final distance of 100m is appropriate, with a flight speed of 8m/s, the maximum altitude is about 10m, and the flight time up to 13 minutes. The big advantage is that the drone is charged with electricity via a microUSB port by high capacity battery. The cost of the device is affordable and amounts to around 120 euros. [6]

The camera in a drone of 5MP resolution is, while the made photos are very good, because the device has electronic image stabilization, which has 2592×1936 pixel resolutions. The images are stored in JPG format and they are recorded by the device in 720p resolution of 30 fps. [5]

The software is specifically designed to precisely manage this device. It can be downloaded free both for devices with have Android and iOS operating system. Thereby the installation process takes a short time and after that the software is ready to operate immediately. All that have to do is turn on the device (by pressing the button on the side) and immediately after enter the name and password of the Wi-Fi network in the software, whereupon the phone and the drone are interconnected. After connecting the cameras, the view in front of the drone will be displayed on the phone screen. In the upper left corner a button that activate drone takeoff is, select flight mode, which includes Throw&Go, Flips, Up&Away, 360 and others, and settings where somebody can select the connection mode (in case with a physical controller, ie joystick), flight speed (slow/fast), VR device, photo quality, low battery mode, bit rate, user manual and more. [6]

Tello allows students to easily and quickly learn the basics of programming process. There is also a possibility of drone reprogramming, by using the Scratch development environment. To stack blocks of commands in program Scratch all listed are needed, according to them the drone will perform tasks, ie move toward given instructions from the previously defined codes. [6]

Flying with the Tello drone is quite easy for users (students). For those feeling adventurous, the Tello is VR-headset compatible for FPV flying. Swipe on a smart phone will activate 8D flips for click aerial movings. For more tactile control, connect a Bluetooth controller to smart phone and after that flying itself is more traditionally oriented. Tello lightweight, yet durable design features software and hardware protections, making it easy to fly with undoubtedly great confidence. [7]

Tello has built-in Bluetooth and two antennas. It uses DJI flight technology, then has auto take-off and landing achievable with just one touch on the screen. Besides of that drone own a system for

precise hovering in place and notification of battery charge, and safe landing even when the connection is lost. It is compatible with VR, has an option for 8D rotation and automatic flying up and down. [8]

Undoubtedly the use of the Tello drone for educational purposes is evident and justified. Aircraft drone allows anyone without prior adequately knowledge and experience to program simple missions, as to practice the development of more complex operations. [9]

#### IV. DRONESBLOCKS APPLICATION

Parallel with the introduction of drones into wider operational use, there have been efforts to proper control them in a correct and simple ways as possible. It is understood by construction engineers that for a particular drone model, a corresponding unique platform for efficient flight control is immediately produced and used.

DroneBlocks is one of the new software for defining and establishing control of drone air operations. With the almost constant update process the latest version of this software is currently 3.3 (july 2021).

DroneBlocks is sophisticated block-based programming application for performing drone movement in the air. It has collection of eight general command groups for programming drone flights (see figure 3), and they are the following:

1. Takeoff order - for drone takeoff,
2. Navigations - group of navigation commands,
3. Flip - commands for the direction of the drones inclination during the flight,
4. Loops - loop commands,
5. Logic - commands logical operators,
6. Math - commands mathematical operators,
7. Variables - commands for variables,
8. Land - order to land the drone.

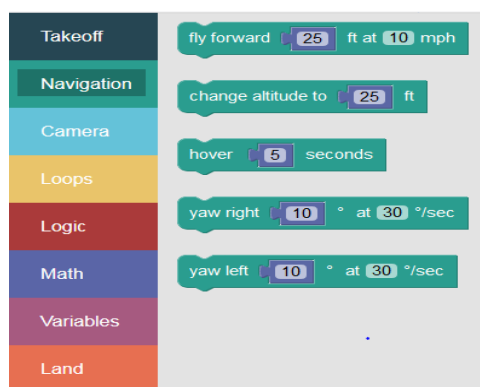

Figure 3. Interface of DroneBlocks Application

The DroneBlocks App is a drag and drop block programming environment, that supports many of the leading DJI drone products. By today the supported drones are following: Phantom 3, Phantom 4, Mavic Pro, Mavic Air, Spark and Tello. DroneBlocks is a free download and available in the iOS App Store, Google Play Store and Chrome App Store.

Using the DJI SDK DroneBlocks allows users to tap into the autonomous functionality of their DJI drone. It is important not only for increasing general student interesting in STEAM subjects, but to teach real applications of specific drone technologies.

Drag and drop coding allows end users to create their own custom flights as projects, with logic and algorithmically settings. By today many creative mission solutions with the help of DroneBlocks have been generated. The possibilities of various autonomous mission realizations are almost limitless with such flexible application for drones.

One of the most popular DroneBlocks feature is the ability to share the formed autonomous mission code with other who are interested. Namely any mission saved to the cloud application can be easy exchange with anyone who uses only computer (phone) and web browser. [10]

Drones can notably help students to develop soft skills and prepare students for demand and unforeseeable professional aspiration and determination. The STEAM approach is surely subject of consideration in a modern education system. With affordable DroneBlocks application, implemented STEAM concept by professors can build student interest in regarding flying drones. It is feasible to take one step further, because they can program drone trajectories independently and then observe in detail phases of flights. So appropriate drone tests can be performed and widely analyzed. The main features of each constituent and belonging STEAM area in figure 4 are listed. [10]

DroneBlocks is a free application that is compatible with Chrome, iPad and Android devices. Application supports teaching coding with the DJI Phantom 3 and 4, Mavic Pro and Air, Spark, Tello, and Tello EDU drones. It is considered as a fun way to introduce, or continue to teach programming concepts along with drone safety and flying techniques. The DroneBlocks app is very valuable in a contemporary educational adjustment and settings. It is normally assisted by curriculum supported teaching and advanced drone programming with Python and JavaScript. [10]

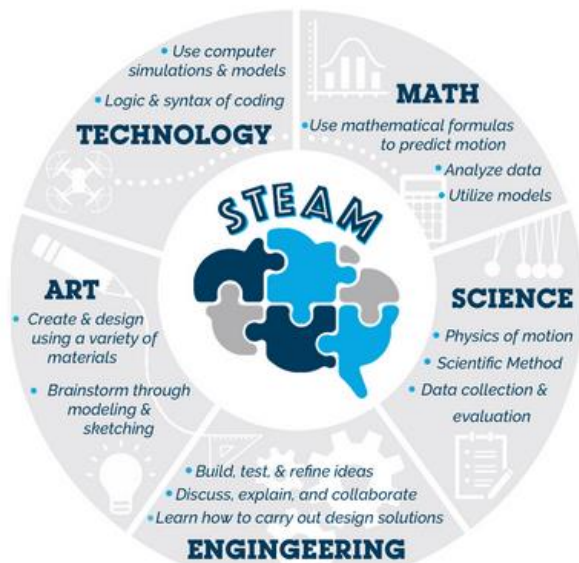

Figure 4. The STEAM concept with DroneBlocks [10]

DroneBlocks is the best way to code flight path before powering operations on connecting drone. The TakeOff block is for instructs drone to start flight. No value is needed, as it tells drone to automatically hover at 4-5 feet. To change the altitude from its current height, can be used a Fly up, or Down block, and then enter the exact distance for the drone moving. It is needed to monitor the max height, or any obstacles, that drone could go into flying upwards, but when flying down, the drone will stop in case it reaches the minimum distance required for landing procedure. [10]

Navigate forwards and backwards by using the Flyforward, or Backward block are done, and entering the exact values in inches (centimeters) for the moving drone. The Tello EDU uses internal sensors to determine distances (not GPS), so it is not precise. Furthermore, Yaw blocks can be used to change which direction the drone nose is facing, while Loop blocks can be added to repeat block commands. [10]

Through this application, programming is not complex and demand, ie. it works completely in block mode for created missions. By selecting and dragging commands from certain groups, to the device is given appropriate instructions, one after the other. At the same time, all done can be viewed in the code display mode from frequently used JavaScript. But there is an option to write code directly, which is certainly a higher level of understanding and implementation programming (visible on figure 5). The written codes should be tested on a real drone connected by a specific channel to the device where the coding is performed. [10]

In DroneBlocks environment on button “Show mission code” from the menu icon can be clicked to view the actual text code of program at any time. When somebody is planning to start a new program mission, then can drag the previous program into the trash, or log in to a open Google account to save some missions. This is recommended especially for classroom using, or when sharing screen display. [10]



Figure 5. Drag and Drop versus JavaScript coding

DroneBlocks application has some unique properties. These features define and determine the potential application areas of the same. All listed can be resumed as follow (figure 5):

Cloud based lessons and videos;

- Clear lessons that build upon each introduced skill;
- DroneBlocks lessons are aligned to include universal education standards;
- True STEAM applications across all subjects;
- Open Source for dynamic block based coding engaging learners of all ages;
- In accordance with iOS, Android, Chrome;
- Collaborative as encourage and incorporate feedback from students, teachers and developers;
- Compatible with more advanced and powerful drones. [10]

Moreover, there are internet resources where registered members, for \$5 per month, will be able to access DroneBlocks Tello Simulator, or to complete course for about \$50. On that way they can explore DroneBlocks coding without a real drone, while this option is compatible with the concept of known block coding. Thus, code execution and drone flight can be realized in a separate virtual content-enhanced environment, as seen directly in figure 6.

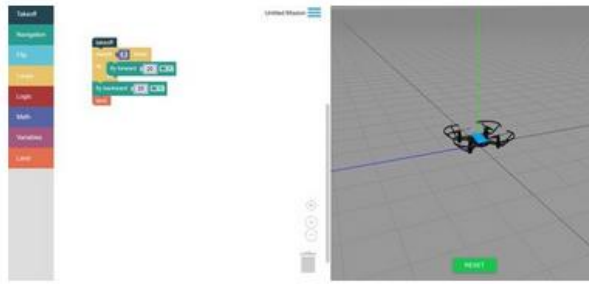

Figure 6. DroneBlocks Tello simulator [10]

Simulators enable developers to test functionality on a virtual phone before deploying to a physical device. This can prove useful and allow code bugs to be discovered early in the development drone lifecycle. The Simulator provides a virtual Tello drone that behaves and acts similar to Tello in the real operational circumstances. It is an interactive 3D environment for DroneBlocks missions to control Tello in 3D. Recently certain drone telemetry to the simulator was added. [11]

Virtual laboratories have significant implementation in modern education process. However, it is important to notice that even though simulation has many benefits, it is not sufficient for complex requested project testing procedures. Only virtual software interface and labs are not a complete replacement for overall running code tests on a real Tello drone. [12]

In addition, some special class with drones can be realized within the section from subject Informatics and Computing in primary and secondary schools. The planned teaching unit refers to the programming of unmanned aerial vehicles, ie drones, in usual occasion. But it is applicable during and unpredictable distance learning when the online platforms (Zoom, Microsoft Teams etc.) are used, as a tool for primary communication with students, and a e-mail channel as a secondary one. If students show observed interest in something more than regular classes, it certainly deserves to show the teacher attention and invest time to a chosen smaller group of students. Also, teachers are usually motivated to continue encouraging students to this activity in the future schooling and designing elective, free activities. The initial analyzes indicate that students mostly expressed a clear desire to continue these types of distance learning. [13]

## V. CONCLUSION

Today there are different drone models constructions in general. Although they are usually intended for commerce and industrial needs and tasks, some of them are quite useful for the education purposes. Such drone types are used during teaching processes - lecture and practice

activities, in colleges and faculties, but partially can be applied in a primary and secondary schools. There is a constant need for new innovative teaching tools in order to improve usually classroom ambient. Drone is valuable multifunctional device from a theoretical and practical education aspect.

Tello is a tailor-made, flexible and programmable drone appropriate for education process environments. By taking drone students study mechanics, control and learn through trial and error. Drones yield students to work hands-on, making learning easier by experiment (test) conditions and develop fine motor skills and hand-eye space coordination.

The proposed DroneBlocks App makes programming drone missions affordable through a well-known, easy-to-use block programming interface. After connecting the Wi-Fi of a laptop, tablet, or smart phone, students can access to the drone system directly, and run their currently and already formed flight missions. Programmed missions as sets of code blocks are assumed, typically beginning with a takeoff, then followed by various commands, such as fly in some direction, yaw, camera, etc. Application DroneBlocks is basically designed for beginning through advanced learning and accommodating different learning methods and types. With the listed equipment students get the opportunities to learn Block, Python and JavaScript coding, by executing created codes using small, friendly Tello drone, that fly autonomously.

JavaScript is among the most powerful and flexible modern programming languages of the web. By using DroneBlocks codes students will be able to engage with these programming language, learn programming fundamental steps and basic of object-oriented concepts. The listed codes will allow students to send JavaScript commands directly to the Tello Drone via usually a Wi-Fi connection.

However, even if students do not have assessment to drone (equipment), they can learn coding by practices through affordable online option covered with DroneBlocks Simulator. Assumed virtual simulator enable users to develop and also test (eliminate errors and deficiencies) special codes fast, in quite easy procedures and safety operational mode. Moreover, there are certain coding options for advanced users, who have moved beyond block coding with simple DroneBlocks. With this approach students can make control system for Tello drone project by using advanced programming languages, like JavaScript and Python.

In the competitive education drones tend to be widely represented and inclusive. Such

technological devices may be applied in various schooling levels and are extremely conducive to students with diverse learning styles, by helping them explore math, science, logic and design principles. Further affordable DroneBlocks a very valid tool for widely present 21st century educators is imposed to teach outstanding STEAM school subjects with block coding and quite innovative drone model construction. Additionally, by adopting drones in a teaching system it will be created positive impact in education at all, where the covered technologies are used for supporting more productive and interactive student learning experiences. In summary, the listed approaches can contribute to the achievements of the teaching goals and fulfilling the demand learning outcomes.

#### REFERENCES

- [1] Development of a 4th-8th Grade Curriculum for Flying and Development of a 4th-8th Grade Curriculum for Flying and Programming Mini Drones Programming Mini Drones, available on <https://digitalcommons.usu.edu/cgi/viewcontent.cgi?article=2225&context=gradreports>.
- [2] Kako i s čime letjeti hrvatskim nebom, available on <https://www.vidilab.com teme/hardverska-tema/4519-dronovi>.
- [3] Five Ways in Which Teachers Are Using Drones in the Classroom, Available on <http://edu4.me/en/five-ways-in-which-teachers-are-using-drones-in-the-classroom/>.
- [4] How Can Drones be Used in Education?, available on <https://www.dronetechplanet.com/how-can-drones-be-used-in-education/>.
- [5] Tello User Manual, available on <https://dl-cdn.rzyerobotics.com/downloads/Tello/Tello%20User%20Manual%20v1.4.pdf>.
- [6] Tello, available on <https://www.itnetwork.rs/tello/>.
- [7] Drone + Curriculum Bundle, available on <https://www.globalairdroneacademy.org/merch/drone-curriculum-bundle>.
- [8] Tello, available on <http://tello.rs/>.
- [9] Javier Alejandro Jimenez Cavadas: *Using Drone Tello Edu for educational purposes*, master thesis, 2019.
- [10] Droneblocks, available on <https://www.droneblocks.io/app>.
- [11] Testing Your Drone Code with the New DroneBlocks Simulator, available on <https://www.droneblocks.io/blog/2020/9/3/test-your-drone-code-with-the-new-droneblocks-simulator>.
- [12] The DroneBlocks Simulator, available on <https://learn.droneblocks.io/p/introduction-to-the-droneblocks-simulator>.
- [13] Aleksandar Mamić: *Drone programming during distance learning, Competition for the selection of the best examples of distance learning - Magic is in the hands of teachers*, 2020.

# The evolution of Web Based Learning Platforms

E. Pavlova Tosheva\*

\*SWU “Neofit Rilski”, Technical faculty, Blagoevgrad, Bulgaria

**Abstract** - In recent decades, e-learning platforms have evolved from tools for disseminating materials and providing quiz-based assessments to sophisticated software systems that provide new learning opportunities. The article describes Modern Web Based Learning Platforms. The main characteristics of Modern Web Based Learning Platforms are considered. Features are presented that expand the opportunities for learning in a web-based environment such as the use of multimedia, collaboration and self-assessment. Cloud Learning Platforms are considered as a new stage in the development of Web Based Learning Platforms. The advantages of the Cloud Learning Platforms are indicated. The Cloud services with application in education are presented. A scenario for application of the Microsoft Teams cloud platform in the education in Technology and Entrepreneurship 5-7 grade is presented.

## I. INTRODUCTION

Advances in information technology, coupled with the changes in society, are creating new paradigms for education and training. These massive changes have tremendous impact on our educational and training systems. Learners, from the perspective of this educational and training paradigm, require rich learning environments supported by well-designed resources [1].

The main factors influencing the development of technology and societies in the 20th and 21st centuries are information and energy. Information technology is becoming part of modern tools for education, training and coaching. Interactive models and mobile platforms for analysis, organization, indexing, visualization and knowledge transfer complete the picture [2].

Web-based Learning Platforms are integrated software solutions for e-learning. They provide a range of tools for transmitting and acquiring new knowledge, skills and attitudes which aims to encourage and guide the learning process through the use of computer and Internet connection.

Web-based learning platforms are gradually becoming an integral part of education and provide teachers with access to tools that not only complement traditional forms of learning, but also have the potential to increase efficiency in the overall learning process. Each platform offers didactic tools in four

main areas - course design, organization of communication between teachers and students, access to additional and external resources and an electronic testing system. This infrastructure allows diversification of didactic approaches and information channels that take into account the different learning strategies and styles of learners in order to maximize the learning content taught.

A modern learning management system, this name not only hints at the time of creation, but says that unlike traditional platforms, the new ones are full of a number of modern features, providing a more personalized and in-depth experience. Each of them aims to make learners and teachers, average users and administrators love their interaction with the platform.

These platforms even provide an opportunity that can cover all aspects of learning, making it engaging, interactive and interesting.

A new wave of modern LMS solutions has emerged that focus on learners' experiences and sometimes on specific pedagogies that are not well supported in traditional LMS solutions. Suppliers in this category include companies such as Docebo, Totara, Litmos, Motivis and NovoEd and many others. Modern Learning System features.

## II. BASIC FEATURES OF MODERN WEB-BASED LEARNING PLATFORMS

Modern Web Based Learning Platforms are flexible, dynamic and can be accessed on the user's preferred device, including smartphones and tablets. Content can also come from a variety of sources, including crowdsourcing, making the information more dynamic and varied for learning.

The main features of modern Web-Based Learning Platforms are:

- User-friendly interface responsive, accessible, and easy to navigate;
- Learner-centric tools and collaborative learning environments empowering both teaching and learning;
- Personalized dashboard providing users with the details of the process, progress, deadlines;

- Calendar allowing tracking of both course and personal events and deadlines. Notifications on new tasks, assignments, deadlines, and due, blog and forum posts, etc.;
- Simple file uploader and management tool that eases the process of organizing the materials, creating folders and shortcuts;
- Roles and permission assignment allowing quickly assign roles to specific users in specific contexts.

Advanced features that extend learning possibilities:

- Ability to use media files for courses.
- Use collaboration tools such as forums, wikis, chats and blogs to share information and ideas, create communities.
- Only evaluation through tests, surveys, conduct seminars that encourage users to evaluate each other.
- Standard compliance with recognized industry standards such as SCORM, AICC, xAPI, CMI 5.
- Tracking progress and completion, allowing tracking of the implementation of the task and the course, assessment of competencies and assessment, preparation of reports;
- A wide range of reward opportunities.

### III. CLOUD TECHNOLOGIES IN WEB BASED LEARNING PLATFORMS

Cloud computing is a computing model of networks of network, and the main task is to corroborate users to use the hardware and software resources on the demand basis by paying money as per the usage. Clouds can be joining up of the resources either physical or virtualized on a centralized propagated data centers. A cloud consists of various types of workloads like batch style backend jobs and client facing applications [3].

Cloud based learning takes the notion of a perpetual, universally accessible, scalable network of computers and applies it to electronic learning-everything from online classrooms at accredited universities, to smaller training modules to be used within companies or other private enterprises. With this technology, learners can access their tools from any computer, regardless of platform, as long as the computer is able to connect to the cloud. Further, as there are spikes in traffic or as the amount of resources available to the users of the system grow, the system automatically adjusts to the need, ensuring that the overall user experience remains relatively the same .

Cloud-based eLearning platform:

- No hardware to purchase or maintain;

- No in-house IT staff required;
- Easily expandable;
- Anywhere and anytime access to training;
- Flexible and customizable;
- Protected and secure access.

Some of the most popular platforms such as Blackboard and Moodle take advantage of cloud technology.

Examples of Cloud Web Based Learning Platforms:

- Haikilearning [3];
- Scholarlms [4];
- Moodle cloud [5];
- Edmodo [6];
- Google Classroom [7];
- MS Teams [8].

The cloud learning environment provided by Cloud Web Based Learning Platforms provides the opportunity for visualization, interactivity, navigation, spatial orientation and individualization of the path to information.

Cloud services with application in education are:

- Cloud office packages;
- Data storage in the cloud;
- Cloud environments for e-learning.

Cloud office packages with application in education are: MS Office 365 and included in Google Workspace for Education - Google Docs, Google Forms, Google Sites and more.

Components of cloud office suites:

Applications for creating and editing documents - MS Word online, Google Docs;

- Communication applications - Microsoft Teams; Meet.
- Calendars and contact management tools - Google Calendar;
- Space for storing the files you work with - Google Drive, OneDrive, etc.

Data storage in a cloud environment:

- Google Drive is a Google storage service that provides the ability to view and edit files in a variety of formats. The free storage space it offers is 15 GB;
- Dropbox is a fast, intuitive and free service with the ability to automatically back up files, which offers 2 GB of storage space, but has the ability to expand up to 16 GB;
- Box is a free and easy-to-use storage service that offers 10 GB of free space.

## Cloud environments for e-learning

E-learning environments are a completely new type of technology in education. These environments provide training tools to support the learning process. E-learning environments are available online and rely on Internet technologies for their existence. In recent decades, e-learning platforms have evolved from tools for disseminating materials and providing quiz-based assessments to sophisticated software systems that provide new learning opportunities.

### IV. SCENARIO FOR APPLICATION OF THE MICROSOFT TEAMS CLOUD PLATFORM IN THE EDUCATION IN TECHNOLOGY AND ENTREPRENEURSHIP 5-7 GRADE

Microsoft Teams for Education provides an online classroom so students and teachers can find new ways to continue to focus on learning — free for schools and universities.

In a distance learning scenario, teams can work seamlessly with multiple LMSes and applications, supporting the important need for online lectures, discussions, and productive collaboration. So in partnership with Teams features, such as meetings, live events, tasks, etc., you can continue to use the same LMS. You can turn off Teams features that aren't right for you and create a multi-tool solution that allows students to do the best job.

The scenario for application of the TEAMS Cloud Platform in the education in Technology and Entrepreneurship 5-7 grade includes:

- Selection of the Teams platform from MS Office.com;
- Creating a class team;
- Sharing and organizing files in a classroom;
- Tasks and degrees in your class team;
- Using a class notebook in Teams.

#### *Selection of the Teams platform from MS Office.com*

Open MS Office.com in your web browser and log in with your school email and password. Select the MS Teams [8], (Figure 1).

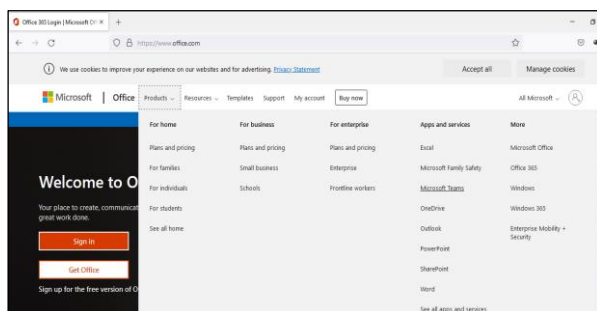

Figure 1. Selection of the Teams platform from MS Office.com

#### *Creating a class team (Figure 2)*

- You may already have classes set up for you by your IT administrator. Otherwise, create one.
- In Teams, select the Teams button from the application bar.
- Choose to join or create a team - Create a team.
- Select a class as a team type.
- Enter a name and Optional class description.
- Select Next.

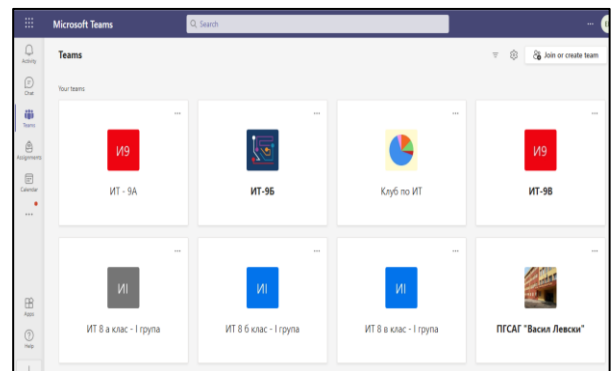

Figure 2. Class team

#### *Sharing and organizing files in a classroom*

Any file you share in a channel or chat can be opened by all students in the channel or chat.

#### *Tasks and degrees in your class team.*

The only way your task should be recorded is a title. All other fields are optional. Title (required).

#### *Using a class notebook in Teams.*

The class notebook provides each student with a place to take notes and work with the class.

## CONCLUSION

Web Basic Learning Platforms have become increasingly common in education. While there is a time and place for face-to-face learning, increasingly learning and courses are being conducted through digital channels. Not only can this be cheaper and easier to manage for businesses, but for educators it also means being able to reach people from a distance. Web-based Learning Platforms are integrated software solutions for e-learning. They provide a range of tools for transmitting and acquiring new knowledge, skills and attitudes which aims to encourage and guide the learning process through the use of computer and Internet connection.

Cloud web-based learning platforms will provide a more flexible and interactive learning environment. They will allow faster communication and data exchange between the individual participants in the educational process. The idea of using cloud technologies in education is to enrich the curriculum so that students are active participants in the educational



process. Cloud technologies allow teachers and students to share text, graphics, audio and video files. They allow the teacher to set group and individual tasks for students electronically, which in turn makes the learning process more flexible and interactive.

## REFERENCES

- [1] Khan, B. (2001). A Framework for Web-Based Learning. Englewood Cliffs, NJ : Educational Technology Publications, 2001.
- [2] Whittemore, B., <https://blog.extensionengine.com/six-types-of-online-learning-platforms>
- [3] Padmaja, K., Seshadri, R., (2016). A review on cloud computing technologies and security issues. Indian J. Sci. Technol. 9(45).
- [4] Haikilearning- <https://my.haikulearning.com/do/account/xauth>
- [5] Scholarlms- <https://www.scholarlms.com/>
- [6] Moodle cloud-
- [7] <https://moodlecloud.com/app/en/signup/chooseuser>
- [8] Edmodo- <https://beta.edmodo.com/home>
- [9] Google Classroom- <https://classroom.google.com/h>
- [10] MS Teams- <https://teams.microsoft.com/edustart>

# Mobile Teaching and Learning – Benefits, Perspective and Challenges

M. Kocaleva\*, E. Karamazova\*, B. Zlatanovska\*, D. Karuović\*\*

\*Faculty of computer science, “Goce Delcev” University, Stip, Macedonia  
mirjana.kocaleva@ugd.edu.mk, elena.gelova@ugd.edu.mk, biljana.zlatanovska@ugd.edu.mk

\*\* Technical Faculty ”Mihajlo Pupin”, University of Novi Sad, Zrenjanin, Serbia  
aruena@tfzr.uns.ac.rs

**Abstract – Rapid development of information and communication technology affects all areas of our life, including education and learning environment. We live in a world where people are addicted to technology. Everyday life cannot be imagined without use of mobile phones, computers, laptops, and tablets. Despite the already existing e-learning, mobile teaching and learning is becoming more and more used. Mobile teaching is about planning and executing learning through mobile devices. This way of learning can influence both the professors (lecturers), and students. This learning is also made possible by the Internet which helps to create modern methods when integrated with the pedagogical instruction. The aim of this study is to review the mobile-based teaching and learning in high education.**

## I. INTRODUCTION

Today information and communication technology are almost everywhere, so also in education. Students learn with use of computers and technology and with their help they develop new skills daily. A new generation of educational tools have been introduced by using mobile devices. Mobile devices include any portable and ease of use, connected technology, such as basic mobile phones, smartphones, e-readers, netbooks, tablets, iPads, and computers [2]. They give quick and easy access to a wealth of resources. Mobile devices lead to new educational model called mobile teaching and learning [7].

Mobile learning is a need, not a want. It is believed that by allowing students to use mobile devices in the classroom, motivation to learn and to achieve increases [3]. Students want information and communication technologies to enhance their university experience, as well as to provide experiences that are transferable to all aspects of their lives [4]. Students want to keep up with new technologies to have a better and more successful career.

Mobile teaching is about planning and executing learning through mobile devices together with

Internet (Wi-Fi or static). The growing popularity of the term ‘mobile learning’ can influence both the professors (lecturers), and students: mainly students who carry the mobile devices and move around with them, whilst the term ‘mobile teaching’ is hardly used at all. Our starting point and our focus are the emphasis on learning, but our attitude towards mobile teaching is to redefine it as facilitation and support of mobile learning.

The purpose of this study is to look at the benefits and perspective of mobile devices in education, and into the challenges to the universities, professors, and students in its implementation.

## II. BENEFITS, PERSPECTIVE AND CHALLENGES OF MOBILE DEVICES IN EDUCATION

Professors and students have positive and negative thoughts about using mobile devices at the same time. Professors are more afraid about using new technologies and methods in learning unlike student. They think that the method good for student - they don’t need books, notes, only device; they worry about student health - using devices maybe affect their eyes, head (headache); they are afraid about losing traditional way of learning with books, classrooms, chalk, table, and the most important students.

According to professors, mobile devices will positively influence on students’ motivation, inspiration, desire to learn more, communication, teamwork, collaboration, and ability to research, make homework’s and projects. But, there are also some challenges they must face up, like:

- there are privacy and safety issues,
- distraction is also one big challenge for professors,

- there is the opinion that students will use the devices for communication with friends and for playing games, and not for useful things,
- management in educational institutions (universities) must take responsibility to block certain applications or websites; and professors and teaching assistant need to move around the class to control and monitor the use of such devices by students,
- not all students have access to modern technology (some families are poor, and some students live in rural environment),
- Some students find it difficult to write lengthy text responses on the device due to lack of keyboards. Use of separate keyboards debilitate better power and reduce portability,
- there is no access to variety digital books, universities should provide students more options,
- reading a large amount of text on the small screen of mobile devices is difficult and may tire and damage the eyes,
- the loss is quite big when gadgets are dropped or misplaced, and there is also possibility of theft of the devices at faculties or other places where the device is used,
- not all students are competent in the use of mobile devices, and they might be frustrated and might not want to explore the capabilities,
- parents and professors are concerned about the damage,
- parents do not trust that their children will be responsible in use of mobile devices and felt possible danger.

Professors know that with trainings, workshops, and continuous work they will overcome the challenges of mobile devices on learning and teaching [1]. They also know that students will adapt and will accept this type of learning faster compared to them.

For use of mobile devices for teaching and learning at universities as high educational institutions internet connectivity with a proxy server is required. At the same time, management of the institution must restrict internet access to avoid inappropriate use. The internet connection must be with account for every student with their own username and password. Universities also must consider adequacy of wireless network required for portability of the mobile devices.

Mobile devices are important to us because they allow us to collaborate, communicate, access information, construct new information, connect to others..., as shown in Figure 1 [4]. They're incredibly affordable. These devices hold great potential for transforming learning. Some additional reasons [4], [5], [8] for using mobile devices in the classroom when it comes to teaching design and infrastructure are (Figure 2):

- Mobility: offer learning on the go, tools for communication away from the classroom, several classroom activities through Internet tools while they cannot physically attend the classroom,
- Versatility: multitasking (tools for studying online, taking notes, attending real-time classroom activities, MS Office tool for working with documents, tools for image editing), speeding learning process,
- Noise –free learning environment: an iPad and smartphone provide touch screen option (versus computer because with computer we used keypads and mouses),
- Interactivity: learning through audio/video mediums, learn in an interactive way using visual elements such as charts, graphs, and images
- Flexibility: adaptive learning environment using various applications,
- Social media networking: communication through social-media websites like Facebook and Twitter. These sites allow students to interact with their colleges, to share knowledge, news, and videos, to get answers for any task and questions from their professors and older university colleagues.

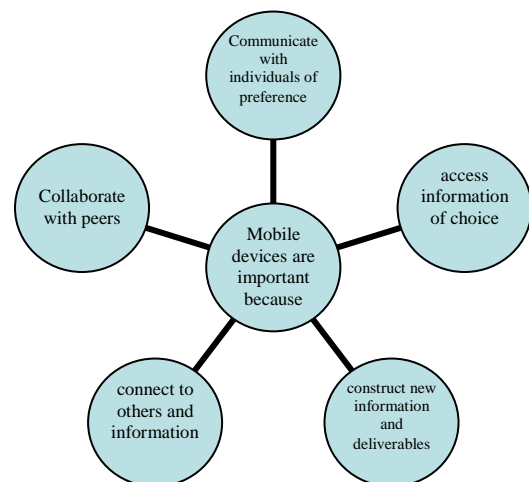

Figure 1 Why mobile devices are important [4]

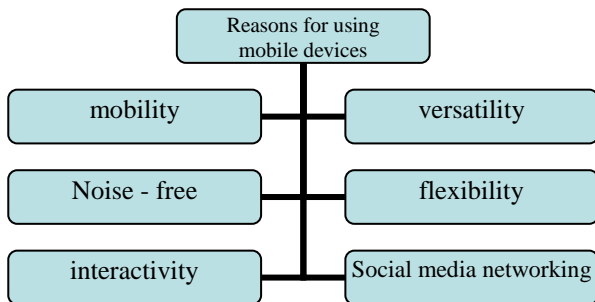

Figure 2 Reasons for using mobile devices [5]

Other reasons why we must use mobile devices in every classroom in high education and what benefits we have, are given below [6]:

- Google for research, anywhere and every time,
- Application with adaptive learning algorithms,
- Application for reading,
- Access to virtual libraries, museums, networks,
- Microsoft Teams platform for teaching,
- Game based learning,
- Project based learning,
- File sharing can be done fast and without any problems,
- Ease for transport,
- Students can create their own workflows,
- Students can plan how to spend their time as they want and prefer,
- Students can have choice in terms of apps, platforms, social channels, assessment style, and so on,
- Using YouTube as most popular media channel,
- Digital literacy is as important as non-digital literacy,
- Headphones, earbuds, and other related peripherals are becoming increasingly common-and useful,
- Can function as a productivity hub for learning-reminders, to-do lists, calendar updates, social messaging, emails, etc.,

- Can be used to take a real time quiz and to give professors data from quick assessments,
- Can be used as calculator,
- Will release the professors,
- Professors can collect data easy.

There was given some of the most important reasons why we must use mobile devices in every classroom, but there are more. More European countries have introduced this kind of learning, so we are not far away. We hope as an institution that we will integrate mobile learning and we will follow the new trends around the world.

### III. CONCLUSION

From the paper we can see that the benefits about using mobile devices overshadow the challenges. Professors hope that this type of learning will become more widespread and will arouse students' desire to stand out in learning in front of their peers and to strive to advance in life and career. The goal of every student and human is to be successful and leave something behind.

Our future goal is to conduct research within our university, as well as with our neighbors in Zrenjanin to see how far our achievements are and whether there are aspirations to progress.

### REFERENCES

- [1] Dias, L., & Victor, A. (2017). Teaching and learning with mobile devices in the 21st century digital world: Benefits and challenges. *European Journal of Multidisciplinary Studies*, 2(5), 339-344.
- [2] UNESCO - United Nations Educational, Scientific and Cultural Organization report, (2013) by Shuller C., Winters N. & West M, *The future of mobile learning - Implications for policy makers and planner*, ISSN 2227-5029 Retrieved March 20, 2016, from United
- [3] Kunzler, G. (2011, September 11). Tablets motivate students to learn, improve the education experience. *Tablet News*. Retrieved from <http://www.mactrast.com/2011/11/tablets-motivate-students-to-learn-improve-the-education-experience>
- [4] Reinhart, J., & Robinson, R. (2018). Digital thinking and mobile teaching. *Journal of Vocational and Technical Education*, 16, 23-46.
- [5] Martin, A. (2013). 6 Reasons To Try Mobile Devices In The Classroom. Retrieved from <https://passnownow.com/6-reasons-to-try-mobile-devices-in-the-classroom/>
- [6] Heick, T. 50 Reasons It's Time For Smartphones In Every Classroom. Retrieved from <https://www.teachthought.com/the-future-of-learning/50-reasons-smartphones-belong-classroom/>
- [7] Grant, M. M., & Barbour, M. K. (2013). Mobile teaching and learning in the classroom and online: Case studies in K-12.
- [8] *Mobile Teaching: Making The Shift To Mobile-First Teaching*. Retrieved from [teachthought.com](http://teachthought.com)

# LMS Conceptual Model That Recognize all Forms of Learning Outcomes

G. Škondrić\*, I. Hamulić\*, E. Junuz\*

\*University “Džemal Bijedić”, Mostar, Bosnia and Herzegovina  
goran@fit.ba, indira@fit.ba, emina@fit.ba

**Abstract - Higher education institutions manage data about learning and teaching process using different learning management systems (LMS). The results of evaluation activities are recorded within the LMS to follow and advice student progress. Evaluation activities grade time stamps are used for validating the acquired qualification.**

Outcomes acquired through non-formal and informal learning are often recognized in the framework of formal learning in accordance with the Bologna Declaration, the Bologna Process, and the Lisbon Convention. The recognizing procedure of acquired outcomes at other educational institutions or within the labor market implies a different procedure from traditional evaluation activities, but not more complex and extensive. The recognition procedure of acquired competencies may involve different evaluation results. Recording the results of the recognition of previously acquired competencies within the LMS represents a new challenge for LMS developers.

This paper presents a conceptual model proposal for recording recognized competencies in the LMS with guidelines for preventing the abuse of the process of recognition of acquired competencies.

## I. INTRODUCTION

The learning process often takes place in environments different than structured formal education. Formal education is structured learning (in terms of learning objectives, time and learning support) at one of the educational institutions that results with an official document on the acquisition of qualification [1]. Competences, knowledge, and skills can also be acquired in the framework of non-formal and informal learning process. Non-formal learning is structured and can be certified or non-certified. Certified non-formal learning includes an evaluation activity with a result that guarantees that the student has acquired the intended outcomes. The student didn't participate in evaluation activities in the framework of non-certified non-formal learning [2].

Informal learning is the process of acquiring competencies, knowledge, and skills during everyday activities, e.g., in the workplace or in free time [2].

Higher education is obliged and seek to make as much as possible the competencies, knowledge and skills acquired within non-formal and informal learning visible, appreciated and recognized according to European Council Recommendation of 20 December 2012 on the validation of non-formal and informal learning [3]. The benefits of recognition are multiple. The student optimizes the time and costs required to gain a qualification. The Recognition of "incoming" competencies can increase the percentage of acquired qualifications and optimize the data on the required average time period for acquiring a qualification, which is one of the indicators of the university quality. The recognition results of informal and nonformal education are not always numerical grades acquired on a particular date. A new challenge for LMS developers is how to store data on recognized competencies, knowledge, and skills on the LMS data layer.

## II. LEARNING OUTCOMES RECOGNITION

The formal higher education process usually is structured in the competencies matrix of qualification (Table 1).

TABLE 1. COMPETENCIES MATRIX OF QUALIFICATION

Required Course	Course Coordinator	Program Outcomes															
		1	2	3	4	5	6	7	8	9	10	11	12	13	14	15	16
GEF		✓	✓	✓	✓	✓	✓	✓	✓	✓	✓	✓	✓	✓	✓	✓	✓
RA1		✓	✓	✓	✓	✓	✓	✓	✓	✓	✓	✓	✓	✓	✓	✓	✓
UPR		✓	✓	✓	✓	✓	✓	✓	✓	✓	✓	✓	✓	✓	✓	✓	✓
UIT		✓	✓	✓	✓	✓	✓	✓	✓	✓	✓	✓	✓	✓	✓	✓	✓
ENGLP		✓	✓	✓	✓	✓	✓	✓	✓	✓	✓	✓	✓	✓	✓	✓	✓
PR1		✓	✓	✓	✓	✓	✓	✓	✓	✓	✓	✓	✓	✓	✓	✓	✓
ASP		✓	✓	✓	✓	✓	✓	✓	✓	✓	✓	✓	✓	✓	✓	✓	✓
UOS		✓	✓	✓	✓	✓	✓	✓	✓	✓	✓	✓	✓	✓	✓	✓	✓
AKS		✓	✓	✓	✓	✓	✓	✓	✓	✓	✓	✓	✓	✓	✓	✓	✓
ENGL1		✓	✓	✓	✓	✓	✓	✓	✓	✓	✓	✓	✓	✓	✓	✓	✓
PR2		✓	✓	✓	✓	✓	✓	✓	✓	✓	✓	✓	✓	✓	✓	✓	✓
ENGL2		✓	✓	✓	✓	✓	✓	✓	✓	✓	✓	✓	✓	✓	✓	✓	✓
SOC		✓	✓	✓	✓	✓	✓	✓	✓	✓	✓	✓	✓	✓	✓	✓	✓
SOS		✓	✓	✓	✓	✓	✓	✓	✓	✓	✓	✓	✓	✓	✓	✓	✓
UBP		✓	✓	✓	✓	✓	✓	✓	✓	✓	✓	✓	✓	✓	✓	✓	✓
DBMS		✓	✓	✓	✓	✓	✓	✓	✓	✓	✓	✓	✓	✓	✓	✓	✓
OGAD		✓	✓	✓	✓	✓	✓	✓	✓	✓	✓	✓	✓	✓	✓	✓	✓
RM		✓	✓	✓	✓	✓	✓	✓	✓	✓	✓	✓	✓	✓	✓	✓	✓
SIV		✓	✓	✓	✓	✓	✓	✓	✓	✓	✓	✓	✓	✓	✓	✓	✓
REP		✓	✓	✓	✓	✓	✓	✓	✓	✓	✓	✓	✓	✓	✓	✓	✓
FinProj		✓	✓	✓	✓	✓	✓	✓	✓	✓	✓	✓	✓	✓	✓	✓	✓
M IS		✓	✓	✓	✓	✓	✓	✓	✓	✓	✓	✓	✓	✓	✓	✓	✓
PIS		✓	✓	✓	✓	✓	✓	✓	✓	✓	✓	✓	✓	✓	✓	✓	✓
SI		✓	✓	✓	✓	✓	✓	✓	✓	✓	✓	✓	✓	✓	✓	✓	✓
WBT		✓	✓	✓	✓	✓	✓	✓	✓	✓	✓	✓	✓	✓	✓	✓	✓
ENGL3		✓	✓	✓	✓	✓	✓	✓	✓	✓	✓	✓	✓	✓	✓	✓	✓
Sport		✓	✓	✓	✓	✓	✓	✓	✓	✓	✓	✓	✓	✓	✓	✓	✓
Project		✓	✓	✓	✓	✓	✓	✓	✓	✓	✓	✓	✓	✓	✓	✓	✓
SEP		✓	✓	✓	✓	✓	✓	✓	✓	✓	✓	✓	✓	✓	✓	✓	✓
HCI		✓	✓	✓	✓	✓	✓	✓	✓	✓	✓	✓	✓	✓	✓	✓	✓
CG		✓	✓	✓	✓	✓	✓	✓	✓	✓	✓	✓	✓	✓	✓	✓	✓
PeB		✓	✓	✓	✓	✓	✓	✓	✓	✓	✓	✓	✓	✓	✓	✓	✓
Pedagogy		✓	✓	✓	✓	✓	✓	✓	✓	✓	✓	✓	✓	✓	✓	✓	✓
Psychology		✓	✓	✓	✓	✓	✓	✓	✓	✓	✓	✓	✓	✓	✓	✓	✓
Didactic		✓	✓	✓	✓	✓	✓	✓	✓	✓	✓	✓	✓	✓	✓	✓	✓
EduMethod		✓	✓	✓	✓	✓	✓	✓	✓	✓	✓	✓	✓	✓	✓	✓	✓
Diplomski rad		✓	✓	✓	✓	✓	✓	✓	✓	✓	✓	✓	✓	✓	✓	✓	✓

The study period or a subset of competencies or qualifications in its entirety can be the subject of recognition. The competencies recognition process involves assessing, documenting, and certifying the competencies that an individual possesses.

Competencies assessment includes:

- determine the scope of competencies that are subject of recognition and determine the number of ECTS, if not specified.
- determine the qualification framework level.
- if they are not explicitly written define competencies.
- compare incoming competencies with the competencies provided by the qualification.

All steps during the competency assessment are needed to be documented. The result of the competencies assessment is the report of the expert commission with attachments. The attachments are documentation submitted by the student as proof of possession of competencies and / or the results of evaluation activities organized by the higher education institution for the student in order to confirm the possession of competencies.

The competencies result certificate is also documented. The certificate of possession of certain competencies should contain precise data on the part of the study that the student isn't in obligation to realize based on the acquired competencies and / or precise data on the missing competencies for acquiring the qualification. The most common form of such a document is a resolution on recognized competencies.

It is often necessary to check the possession of competencies through evaluation activities in the process of non-formal learning recognition as part of formal education. The result will be certificate of competencies possession that provide the same higher education institution that conducts the recognition process.

The recognition can be individual or cohort. Individual recognition is done for each specific student, while the cohort recognition is done for groups, e.g., when a candidates group from one curriculum decides to learn according another curriculum.

### III. PROBLEM IDENTIFICATION: THE RESULTS OF RECOGNITION RECORDING

LMS usually implements relational data model for storing data about student as a grade for each individual course, exam date, and teacher data. An example of recording the evaluation results for one

course at LMS at Faculty of Information Technology, Džemal Bijedić University in Mostar is shown in Figure 1.

Figure 1. The example of recording the evaluation results at LMS [4]

This data are well structured and usually are stored in relational database (Figure 2).

StudentID	PredmetID	ocjena	datum	ProfesorID
-----------	-----------	--------	-------	------------

Figure 2, Table in relational database for storing evaluation results

The competencies recognition results contain documents and often contains also several related documents that are not adequate for storage and use in relational databases. The documents used in the recognition process can be in semi-structured and unstructured form.

The paper authors propose to use the NoSQL database and document data model to store documents that are input and output of recognition process. MongoDB is a document database with the scalability, flexibility, querying and indexing that is needed.

### IV. CONCEPTUAL MODEL PROPOSAL FOR RECORDING RECOGNIZED COMPETENCIES IN THE LMS

The conceptual LMS data model that supports the management of structured, semi-structured, and unstructured data is a multi-model data. LMS multi-model data contains relational data model for storing structured data and document data model for storing full text, querying structured and unstructured data.

Proposed conceptual model in this paper is multi-model databases to support multiple data models in a uniform platform with a single query language. full-text search, which is a critical data access model in today's environment. Data should be stored in a single unified database with support for relational, full-text search, and machine learning

(ML) queries. Data model for document store uses MongoDB API for data access and querying API.

Documents are stored in MongoDB. MongoDB stores documents in a collection. A collection is a group of documents (Table 2).

TABLE 2

MongoDB	RDBMS
Document	Row
Collection	Table

Unlike a table that has a fixed schema, a collection has a dynamic schema.

It means that a collection may contain documents that have any number of different “shapes”.

MongoDB stores document as JSON object. Each object is uniquely identified by `_id` field. `_id` field contains a unique ObjectID value.

Resolution of recognition document is JSON object:

```
{_id: value1,
 ECTS: value2,
 Competences: [array, array2, ...]
 Courses: [array, array2, ...]
 Embeded_documents: [_id1, _id2, ...]
}
```

Xplenty is tool for integration of data from MongoDB with data from a relational database. The Xplenty dataflow loads data from MongoDB and SQL database, split that data into keywords, joins all the data, the query result calculates and finally stores the results. Xplenty's native connector does this in just eight steps (Figure 3):

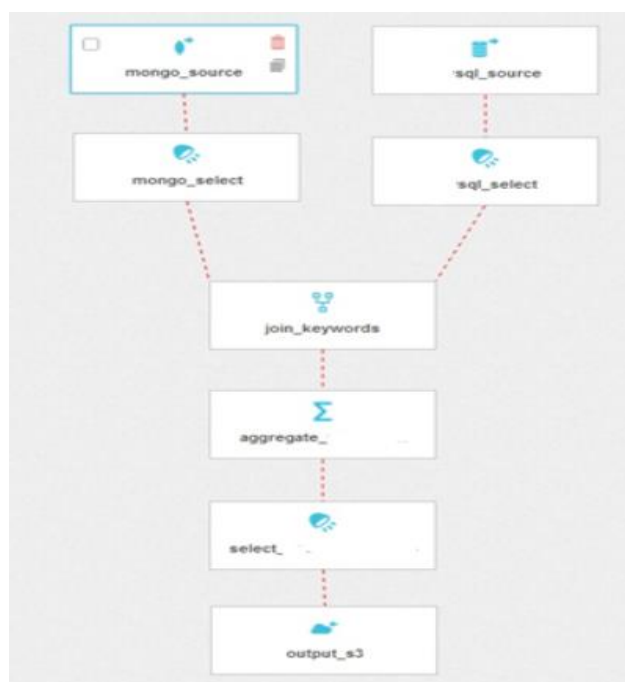

Figure 3. Integrating MongoDB and Relational database

1. mongo\_source - loads data from MongoDB
2. mongo\_select - removes unnecessary fields and separates content into keywords using the Flatten(TOKENIZE(text)) functions
3. sql\_source - loads related data from the relational database
4. sql\_select - removes irrelevant fields and cleans keywords using the Flatten(TOKENIZE(REPLACE(synset\_term s,'#\d+',))) functions. The REPLACE function removes hashtags and numbers from the keywords. Since one database entry may contain several conjugations of the same keyword, the Flatten and TOKENIZE functions split the text per keyword.
5. join\_keywords - joins data from both sources by keyword.
6. aggregate – aggregate results from both sources
7. select - calculates the result
8. output\_s3 - stores results

## V. CONCLUSION

This paper has the aim to increase awareness that all learning has value and must be made visible and recognized. Storing the recognition results of incoming outcomes and competencies requires the introduction of a multi-model data layer.

Proposed conceptual model prepare data from MongoDB and relational database for all analytics needed.

Recommendation is implemented blockchain system for verification of diplomas and educational progress of the individuals [5].

Future work should be focused on optimization of querying multi-model database.

## REFERENCES

- [1]. Hager P.J. (2012) Formal Learning. In: Seel N.M. (eds) Encyclopedia of the Sciences of Learning. Springer, Boston, MA. [https://doi.org/10.1007/978-1-4419-1428-6\\_160](https://doi.org/10.1007/978-1-4419-1428-6_160)
- [2]. <https://europa.eu/europass/hr/node/448>, (12.5.2021.)
- [3]. RECOMMENDATIONS COUNCIL RECOMMENDATION of 20 December 2012 on the validation of non-formal and informal learning (2012/C 398/01), [https://eur-lex.europa.eu/legal-content/EN/TXT/PDF/?uri=CELEX:32012H1222\(01\)&from=EN](https://eur-lex.europa.eu/legal-content/EN/TXT/PDF/?uri=CELEX:32012H1222(01)&from=EN), (14.5.2021.)
- [4]. [www.fit.ba/lms](http://www.fit.ba/lms), (22.6.2021.)
- [5]. Shannon Bradshaw, Eoin Brazil, Kristina Chodorow; MongoDB: The Definitive Guide: Powerful and Scalable Data Storage, 3<sup>rd</sup> edition ISBN-13: 978-1491954461
- [6]. Goran Škondrić, Indira Hamulić, Eugen Mundić (2021); Conference: Conceptual model of educational blockchain system for diploma indisputability at: ICISCT 2021, Tashkent, Uzbekistan

# Pedagogical Dimension of Teaching Informatics and Computing

S. Šević\*, D. Glušac\*

\* Technical faculty Mihajlo Pupin, University of Novi Sad, Zrenjanin, Serbia

**Abstract** – Conducted study concentrates upon media influence on student education in social context of teaching informatics and computing, while observing legal aspects of schooling. Study is also analyzing tendencies of human behaviour and computational cogitation. Hence, subject matter of this research is educational potential of Informatics and computing as a school subject, considering its growing significance, as it is becoming an essential need of modern society.

## I. INTRODUCTION - THEORETICAL BACKGROUND

Education is a process combining knowledge, skills and habit adoption, psychophysics strength and skills development, forming a scientific and personal perspective, as well as empowering the self-education and self-edification. “Term education, also implies involuntary, unaware and adventitious behaviours. These behaviours can affect personal development in a positive or negative way.”[9]

“In a more strict sense of term, teaching entails processes of embracing knowledge, building skills and habits; enhancement of abilities, adopting ethical values and code of conduct. Teaching is a core element of entire education; it is a fundamental aspect of personal upbringing. It refers to process of personal development and it involves all of the social influences, circumstances and individual activities of a person.”[9]

Educational goal of the modern society is set in such a way that all of the elements of education, through its procedures, contents and assets, strive to versatile personal development.

Special attention is paid to needs, interests and abilities of a child.

“The goals of education:

1. Represent personal development with particular traits
2. Is always socially determined, or conditioned (however, an individual can be educated in a special manner, where the goals can differ from those that are socially established),

And they are varying according to changes in society – different societies cherish different educational goals.” [1]

Students spend large portion of the day in school. Therefore, it is unnatural to demand for it to be and treat it as a pure tutoring institution. School is responsible for organizing education of children and young adults throughout the period of the most intensive personal development, thus its importance is of undeniable significance. Main role of the school is not just passing knowledge to students, but it is pedagogical community for complete personal development. “The growing efforts to promote children’s rights causes modifications of position of students, as well as teachers, these changes are often a debating point and subject of critical examination.” [10] Although the teacher's role is transformed, it is still of great importance, since the teacher remains an important influencing factor.

First tie student creates in school is with its teacher. Through this relationship, student builds self-confidence, an attitude towards given subject and, usually, towards the schooling itself. With his own mannerisms, teacher can improve the learning process.

Education of a student is under great influence of the way their non-verbal views and outlook on certain value systems are accepted.

“Teacher authority is no longer granted by the position, but the teacher has to earn it by his/her own didactic-methodical abilities and through principles of psychological pedagogy. Nonetheless, with increasing numbers of educational factors, teacher has to fight for its position. Perceiving teachers role as only an aid for learning and obtaining new information is very dangerous point of view. Process of knowledge acquisition is only a ground level of education.” [6]

Grading students should maintain its purpose as an insight for the student in his/her learning process and the progress he/she made. It can have



motivational purposes in case it is not criterion for determining comprehension level of what has been taught. Utilizing grades as punishment measures, i.e. to intimidate student for lack of discipline during class, can lead to resistant attitude towards learning or given subject, as well as losing motivation for further cooperation and advancement.

If a teacher doesn't see him self as a person responsible for guiding students and helping them develop their skills and broaden their minds, there can be negative outcomes. Every teacher teaches and educates their students with the personality and mannerisms they manifest during class, aware or unaware; and it has much bigger impact on students then the planned procedure alone.

Statements as "It's all due to bad parenting", "That child is plain malapert" or "He is fully-formed individual" are not uncommon. Listed sayings are degrading to teachers and education is perceived as one task with one simple goal. Also, there are situations where parents assume it is on schooling system to evoke radical improvements in child's behavior, while neglecting the fact that cooperation between school and parents is important prerequisite for optimal development of students. Educational role of school is attainable and increased if schools and parents collaborating, since in that case we have two critical factors allied and working towards the same goals.

## II MEDIA IMPACT ON CHILDREN EDUCATION

"Pedagogy, as science, determines two types of personal development factors:

1. Biological factors – genetically inherited traits and behaviors
2. Social factors – society impact

Both groups of factors consider activities of a child, as without it growth of a person is impossible."[2]

One of social factors is mass-media. It is obvious that all types of media entered our homes, as well as the educational and teaching processes. Negative effects in early and middle childhood are conspicuous, yet it is possible to overcome them. The biggest challenge every educator, professional or unprofessional, is exposing positive mass-media effects.

Day to day encountering with audiovisual arts, enriches and refines sensory perceptiveness of a child, defines certain tastes and stimulates curiosity

and desire for expressing thoughts and feeling by motions, lines, sounds, colors etc. Proper utilization of mass-media could improve educational and teaching process, as well as make it more interesting, creative and extensive.

Some media has got very attractive contents, which is very captivating to kids. Mass-media presence at the home, kindergarten or school has a certain impact on the way a child perceives its surroundings and its experiences. Children coming from media involved surroundings have got wider information sources and could be better at managing through some situations. However, modern media presence does not guarantee better and more rapid intellectual or any other development of a child.

It is possible to include e-learning in teaching the first graders. Today, there are numerous educational software applications that could be well-utilized in schooling. That way students have an opportunity to get familiar with using computers and their basic features, all as a part of a school subject. Nowadays, subject „From toy to computer“ is very well appreciated.

## III ALTERED BEHAVIOUR OF YOUNGER POPULATION IN DIGITAL AGE

Computer took a central spot of today's media. Children of modern society, from their youngest age, are exposed to computers and Internet. Power of said two things is immense. World Wide Web is a great tool, especially for children willing to learn and research different topics. It is the world's greatest library, available 24 hours a day, every day of a week, which is why it is very important to talk with children about Internet, its usage, potential and dangers.

„According to recent studies conducted by UNICEF, kids start using Internet before they are six, and in 90% cases - for 80 minutes daily, on average. Today, it is quite normal to have multiple computers, desktop or laptop. There are homes with one shared device, however, way more often children have their own computer; also, we must not forget smart phones and tablets. It is important to consider the fact that a third of all Internet users world wide are children and teenagers.“[6]

The surroundings of children nowadays has been significantly changed. Before they learn how to talk, they are encountering different technologies, as smartphones or tablet devices. Exposure to digital media during early stages in life is causing alterations in forming neural structures, which is

later manifesting in child's behaviour. Older generations started using computers in their twenties or later, when they were fully developed in neurological and psychological sense, while modern children are exposed since their birth. Through digital toys, children are getting quite intensive stimulations, founded on excitement and engagement of neural system. All of the stimulants from virtual world are drawing attention of children away from books, studying and events in social surroundings. Since Internet has its perks and flaws, time spent surfing Internet and the quality of it are very important.

Internet and mobile communications became an inevitable part in a day of a child (at their homes, at educational institutions, their social groups etc. Appropriate to such high involvement levels of Internet, its dangers are multiplied, and inconveniences and child exposure to disturbing content are evident. At the moment, according to research [4] it is concluded that the school is more traditional institution than family, since it is promoting traditional values, as obedience and respecting the authorities.

### III AIMINGS OF INFORMATICS AND COMPUTING SCHOOL SUBJECT

The goal of subject Informatics and computing is "obtaining knowledge, skill development and forming healthy value system. They are together contributing to computer literacy, which is essential for modern education, life style and work. Also, one of the main goals is teaching students to efficiently and rationally use computers, while being cautious of mental and physical health.

It is very important for students to understand the significance of computer literacy in everyday life, as well as the huge impact informational technologies have on development and functioning of modern society. Basic things students should learn and understand include: working in text editors, programming languages, operative systems, programming conventions, directory system architectures in different operative systems etc. Students are acquiring computational knowledge through three main topics: informational communication technologies, digital literacy and computing. Regarding computing, the new trend is visual programming. One of the main results of attending this class is developed digital literacy, as one of the essential skills of the 21st century.

School subject agenda considers the fact that the incoming generations are born in digital era and

they already have quite experience in using these technologies on a daily basis. Informatics and computing are supposed to help students to understand Informational technologies better and learn them how to use them safely. On the other hand, programming is giving students a chance to enhance their logic and problem-solving skills.

The following list contains the specific goals of the school subject, correlating educational practices:

- understanding the significance and benefits of the Internet and who are trained to protect their safety on web services,
- understanding legal and ethical regulations using ICT and ability to discuss the consequences of violations,
- encouraging interests in modern technologies, creativity and inventiveness,
- improving problem-solving skills
- being aware of side effects of unrestrained and improper computer usage, as well as perks of healthy life styles
- developing critical skills, especially regarding choosing information sources and later displaying gathered pieces of information in a conceivable way
- precise, timely and correct working, along with persistency in solving problems
- improving creativity (developing original ideas and independent thinking), as well as practical skills for everyday life
- acquiring healthy habits and getting better at collaborating with others".[5]

### IV EDUCATIONAL INFLUENCING THROUGH INFORMATICS AND COMPUTING

"Educational values of information technologies cannot be avoided, since these technologies became a necessity in teaching policies, programs and practices. Utilizing ICT is changing and improving teaching, as well as its goals and results and roles in teaching process, between students themselves, as well as between students and teachers, in manner of digital natives and digital newcomers."[2]

Present-day students are not just different than previous generations in a fashion sense or slang, as it was the case in the years before. Newer generations, from kindergarten to college, are the first ones that grew up side by side with modern

technologies. They are surrounded by it since they are born and have been using computers, gaming consoles, smart phones etc. their whole life.

UNESCO pays special attention to utilizing ICT; connecting and expanding with new cultural, social, cognitive and professional aspects of teaching, on national, regional and global levels. Using ICT could be one of the most important factors of stable global development.”[7]

Plans and strategies regarding future use of Informatics and Computing will become quite obvious as soon as ICT become essential part of education. Apparent indicators of previously said, are changes made in teaching trends, new teaching methods are introduced, there is new perspective and approach considering schooling and gaining knowledge, all due to abrupt changes in last two “pandemic” years. Rapid progress of Informational technologies is having a great impact on education itself, as it is changing it more and more.

Computer ethics, as a field of applied sciences was introduced in USA in mid 1980s, focusing on responsibility matters, software defects, private data protection and copyrights, intellectual property rights and confidentiality.

“Computer ethics is founded on rights and responsibilities, regardless of ethic and axiological concepts concerning these particular circumstances. Computer ethic rights and responsibilities are deeply connected with legal rights and responsibilities, as it is the case in many other domains of applied ethics. Legal documents are usually evaluated according to their ethical aspects, while amendments of the law or legal files or addendums, are requiring more and more ethical principles involved. That is a wider context for analyzing specific cases of computer use in education.”[7]

For example, M. Woodbury in “Defining Web Ethics” claims that certain, clear and easy-to-follow rules of traffic regulation for amateurs and professionals are necessary in using Internet. According to Woodbury, contemporary web technologies enable anybody, without any special training or knowledge of universal ethical standards, to be e.g. Internet ‘publisher’.”[11]

It is important to encourage students to be responsible users, in every class. Especially in context of using Internet, and not only regarding their activities on the Internet, but they should be thought to help others as well. In digital world, just as in real world, it is necessary to follow the rules of conduct, to be reasonable, respect others and protect

yourself. Children should be thought how to use digital technologies without jeopardizing their curiosity, social relations, emotional health and moral code.

“It is important to strengthen socio-emotional skills, in order to reduce many risks of inappropriate ICT use (of Internet bullying, above all). The key is critical thinking, self-confidence, self-awareness, decision making, academic integrity, self-discipline and emotion and impulse control. In the most of the cases, children with raised risk level of negative ICT impact, are those with underdeveloped social and emotional skills.” [5]

“Computational thinking is a basic prerequisite for understanding future technologies. It is cognitive process of generalizing solutions for indefinite problems, regardless of device or language expertise.”[8] This is the reason why computational thinking can be part of every class, even the ones for the youngest. Teachers should provide students with teaching and learning processes that would help them understanding and entering digital world.

Modern ICT gave people incredible opportunities. Research or essay assignments for students about contributions of contemporary technologies, life quality and health, could be a good method for developing positive attitude towards scientific endeavor.

Contemporary technologies have many advantages in implementation and presentation of different school projects. Through that, a great correlation between different school subjects is made. E.g. during Informatics and computing class, students can interpret and make a digital presentation of project results they made as an assignment for some other class. Creativity is nurtured through making Power Point or any other presentations, designing pictures or different items, creating websites etc.

“Violent behavior and modern technologies” could be an appropriate topic for school projects. By suggesting students to create a list of relevant web sites concerning social and emotional scopes would be a task that can benefit the team-working skills, tolerance, empathy and persistence.

Teaching Computing class can also be used as educational influence. Teacher can talk about steps of certain processes, preconditions for beginning of that process and consequences of it, and it can create a foundation for algorithm thinking regarding human behavior and consequences of particular deeds and situations.

“Computational thinking is an important skill that could help children solving problems and making decisions. It is one of the fastest methods for obtaining such skills. By strengthening these skills, we are helping kids becoming better at finding solutions, be better thinkers and future programmers. **For the start, curiosity is enough.**”[8]

“However, since the importance of Informatics and Computing, as basic academic discipline, is prone to changes and misunderstanding, in the recent years this school subject has been neglected or even taken away in some countries. Serious concerns arose for this decadence and we are inviting students to gain essential understanding, skills and approaches which derive from computational thinking, before they graduate from high school, or earlier.” [3]

### CONCLUSION

This research was investigating relations between educational aspects of teaching Informatics and Computing to children and adolescents, as well as connection of parent controlling Internet activities of their children and problematic Internet use. Goals and values, along with experience and relations, are presented with possibilities and constraints of teaching. Pedagogical and psychological factors and aspects of teaching Informatics and Computation are strongly emphasized, as well as teaching methods in

developing computational thinking i importance of practice in solving IT problems.

Teacher’s role is highlighted, since it has got a crucial part in empowering development of learning value system, safety of self and others and similar, through teaching Informatics.

### REFERENCES

- [1] Bakovljev M., Trnavac N., Grandić R., Potkonjak N., (n.d), Cilj i zadaci predmeta,
- [2] Backović, A., Vujović, S.,(2018), “Razvoj socijalnih i emocionalnih vještina u osnovnoj školi-Moje vrijednosti i vrline“.,Vodič kroz predmetne programe, Podgorica,
- [3] Computer Science Teachers Association, International Society for Technology in Education. (2011). Computational Thinking: Leadership Toolkit (1st ed.). Retrieved 2 April 2017,
- [4] Mustafaoğlu R, Zirek E, Yasacı Z, Razak Özdinçler A. (2018) The negative effects of digital technology usage on children’s development and health. *Addicta: The Turkish Journal on Addictions*,
- [5] Nikken P, Oprea SJ. (2018) Guiding young children’s digital media use: SES-differences in mediation concerns and competence. *Journal of Child and Family Studies*.
- [6] Pešikan A., Lalović Z. (2015) Uloga škole u razvoju vrlina, vrijednosti i vještina učenika i učenica – Izvještaj o rezultatima istraživanja (Inicijativa „Moje vrijednosti i vrline“). Podgorica: UNICEF Crna Gora i Zavod za školstvo Crne Gore,
- [7] Plemmons D., Behnam T. (2020), *Science and Engineering Ethics*,
- [8] Računarsko razmišljanje, najvažnija vještina budućih generacija, (n.d)
- [9] Savez vaspitača, (n.d), *Pedagogija*
- [10] Vygotsky LS.(1986) *Thought and Language*. Cambridge, MA: MIT Press;
- [11] Voodburi M. u delu „Definisanje veb etike“

# The Influence of ETOS on the Quality of School Work

S. Jokić\*, V. Srdić\*\*, I. Kostovski\*\*\*

\*University of Novi Sad, Technical Faculty „Mihajlo Pupin“, Zrenjanin, Republic of Serbia

\*\*International univerziti in Novi Pazar

\*\*\*Primary School „Miloš Crnjanski“, Žabalj, Republic of Serbia  
snezana.jokic@yahoo.com , colle977@zahoo.com

**Abstract - The thesis examines the impact of ETOS on school quality, i.e. to what extent it affects the grade given by the external inspection and the external evaluation of the school itself. The aim is to prove that ETOS influences the evaluation of the external inspection and that by increasing the evaluation from ETOS, the grade of external evaluation also increases. The research is based on reports collected from primary schools on the territory of the municipality of Žabalj, and the research instrument is the report on external evaluation. It is expected that the results of the research will serve as a starting point for the improvement of the school's ETOS, which will later result in a higher grade during the external evaluation as well as the improvement of the school's quality.**

## I. INTRODUCTION

ETOS – The notion used to refer to overall atmosphere in a school, which includes tolerance, the sense of togetherness, good interpersonal relationships, nurturing of partnership both within a school and with a local community, the sense of safety, care for students, and the number of other factors contributing to the overall atmosphere.

Evaluation – what is it?

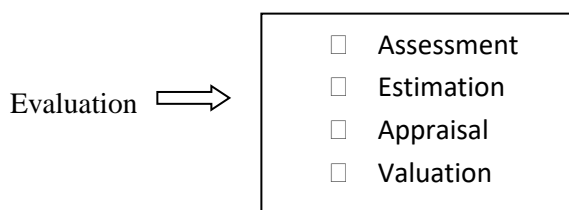

There are two kinds of evaluation:

1. Internal evaluation, which refers to assessment within a school and

2. External evaluation, which is conducted due to the order of the Ministry of Education, Science, and Technological Development, and is implemented by school management.

Evaluation can also be:

- Formative – directed at the process itself and aims at further improving learning outcome and
- Summative evaluation, which is directed at the result and aims at further improving the learning process.

Besides evaluation, there is also self-evaluation, which assesses the quality of school work. It has to be internal, given that it is done within a school, and formative, as it is concerned with the process and aims at improvement of work done within a school.

The purpose of self-evaluation is development. Self-evaluation is done within a school, and, to be conducted, it needs an action plan.

The aim of evaluation is a critical analysis as well as tracking the quality of education, with the goal of providing a possibility of timely and effective impact on the process of education in order to achieve its optimal efficiency and high quality.

## II. RESEARCH METHODOLOGY OF HOW ETOS AFFECTS THE QUALITY OF SCHOOL WORK

### A. Research topic and research problem

- The research topic is the study of the influence of ETOS on the quality of school work.

- The research problem is underlined by the question: to what extent does ETOS affect the score of the external committee, i.e. what is its impact on external assessment and to what extent it benefits a school's promotion and its quality.

### B. Research goal and task

The goal of the research is to empirically analyze the impact of ETOS on the score given by the external committee and on the external assessment of school in Žabalj municipality. The goal and the task of this research is to determine the following: Is the ETOS score given by external evaluators closely

related to the overall score determining the quality of school work.

*C. The main hypothesis and the sub-hypothesis*

The main hypothesis: It will be determined that ETOS affects and improves the overall quality of work done in a primary school, or in an educational facility being assessed to a great extent.

The sub-hypothesis: With the improvement of the ETOS score, the score of external assessment will be raised.

*D. Variables*

Variables that are taken into account in this research are the following:

- Interpersonal relationships within school are regulated.
- Students’ and teachers’ results are praised and promoted.
- The school is a safe place for all.
- The school environment is pleasant for all.
- Collaboration is enabled on all levels.

*E. Research methods, techniques, and instruments*

Methods employed in this research are descriptive and experimental. The technique used involves the analysis of the gathered data, whereas the instrument is the data collected from schools that acted as research participants.

*F. Research environment and sample.*

Research environment is Žabalj municipality.

Research sample is presented in table 1.

RESEARCH SAMPLE	
School:	Collected data:
“Miloš Crnjanski” Primary School, Žabalj	YES
“Đura Jakšić” Primary School, Čurug	YES
“Žarko Zrenjanin” Primary School, Gospodinci	YES
“Jovan Jovanović Zmaj” Primary School, Đurđevo	NO
Overall:	3/4

Table 1. Research sample.

**III. RESEARCH**

During the 2019/2020 school year we have collected data, i.e. school reports on external assessment. Out of four primary schools that the research is concerned with, the primary school in Đurđevo was the only one that did not participate in research, as the school principal refused to provide

the documentation needed, even though we have officially requested it, and disregarding the fact that such data should be accessible to the public.

*A. Research Analysis*

RESEARCH ANALYSIS			
School in:	Data Collected:	ETOS score:	Overall score:
1. Primary School Žabalj	YES	(3.60) 4	4
2. Primary School Čurug	YES	(2.60) 3	2
3. Primary School Gospodinci	YES	(3.00) 3	3
4. Primary School Đurđevo	NO	0	0

Table 2. Research Analysis

As it can be seen in table 2. and graph 1., the only school that got the ETOS score of (4) is the one that got the overall score of (4) as well.

The rest of the schools have the ETOS and the overall score of the same value, or they have the overall score lower than that of ETOS.

The analysis of the results concludes that the ETOS score and the overall school score are closely related. The quality of school work is improved as the ETOS score is improved, which altogether contributes to the improvement of the external assessment score. Thus, it can be concluded that every school, with its principal, in collaboration with school’s pedagogists and psychologists, teachers, and other school employees, as well as with students, parents, and local government, should aim at improving ETOS as well as collaboration and respect, given that every good score, apart from prize, carries a certain weight, mainly related to the fact that there is a responsibility to maintain and further improve the score obtained.

Every school should attempt at eliminating its own mistakes. Self-evaluation should always serve as a tool to obtain information on the content of everyone involved and, if needed, on how to further improve the work done within a school. If one is to point at a mistake, it should not be considered as something malicious, but as a driving force to improve the school atmosphere. Surveys and questionnaires on various ETOS areas, together with school reports, are valuable tools on obtaining data and facts on what needs to be improved.

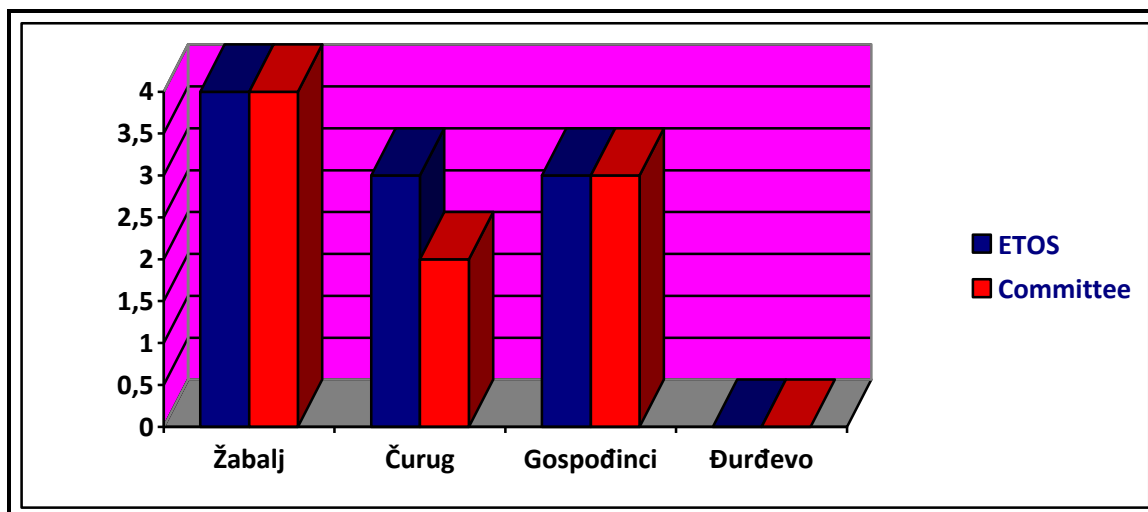

Graph 1. Graphical Representation of Research

Information should be collected regularly (on daily basis) so as to get to the problem solving as quickly as possible. A school that deals with issues that have been pointed to represents a school that is always willing to cooperate in order to raise its work quality to a higher level. A practice that gives us poor results tells us that it is the one that should be terminated and replaced with new models that serve to improve the quality of school work.

Every school should have its own goals and objectives if it attempts at not falling behind when it comes to daily novelties and innovative trends. A school should work on improving its reputation, result promotion, behavior, interpersonal relationships, supporting positive work environment, effective communication with all ETOS participants, as well as improving the collaboration and mutual respect of all employees.

It goes without saying that schools such as the Primary School in Đurđevo (which refused to provide information needed) are not ready to tackle the issues that keep piling each day. The best solution for such schools is to start from beginning and collaborate with schools that have the score of 4, and which would serve as mentors thus pointing at both the problems and the solutions.

As expected, this paper proves that without interpersonal collaboration there is no well organized school. If all aspects within the school are good or great, and if there is a sense of common goal among the people involved, a school cannot be assessed as the one that does not fulfill its tasks.

The sample of this research encompasses the area of only one municipality (Žabalj municipality) and cannot, as such, be a criterion for the entire

country. However, it represents a clear indicator that ETOS clearly affects the overall school score when it comes to evaluating the work quality of a facility, based on the standards of the facility's work quality. With the help of self-evaluation and external assessment of a facility's work quality, every school can eliminate or fix the shortcomings in its reports, but also further improve the areas that have been up to the standard so far.

#### IV. DEVELOPMENT GOAL

- Each school should primarily work on eliminating its own mistakes.
- Self-evaluation should serve as a tool to answer the question of whether all the people involved are content and to what extent, as well as how to improve the work within a school.
- If one is to point at a mistake, it should not be considered as something malicious, but as a driving force to improve the school atmosphere.
- Information should be collected regularly (on daily basis) so as to get to the problem solving as quickly as possible.
- A school that deals with issues that have been pointed to represents a school that is always willing to cooperate in order to raise its work quality to a higher level.
- A practice that gives us poor results tells us that it is the one that should be terminated and replaced with new models that serve to improve the quality of school work.

*“We should give our best to try and not let our schools grow old and tired, to not let our educators grow old either, and to let our children come to school of their own youth, and not ours.”*

*Dušan Radović*

**International Conference on Information Technology and Development of Education – ITRO 2021  
November, 2021. Zrenjanin, Republic of Serbia**

**REFERENCES**

- [1] Borislav D. Stanojlović – „ Fundamentals of pedagogical diagnostics “ Beograd 2013.
- [2] Đuro Šušnjić – „ Dialogue and Tolerance “ Beograd 1997.
- [3] Zoran Bujas – „ Introduction to the methods of experimental psychology “School book, Zagreb 1981.
- [4] Jerald, Craig – „Teach to the Test? Just Say No“ - Reading Rockets 2015.
- [5] Mladen Vilotijević – „ Didactics 1,2 i 3“ Beograd 1999.
- [6] Mladen Vilotijević – „ Evaluation of pedagogical work of the school “ Beograd 1992.
- [7] Šalva Aleksandrovič Amonašvili str.33 – „, Knowledge “ Moskva, 1980.
- [8] Institute for the Advancement of Education - "Rulebook on evaluating the quality of work of institutions"
- [9] <https://zuov.gov.rs/wp-content/uploads/2019/02/Pravilnik-o-vrednovanunju-kvaliteta-rada-ustanove.pdf>
- [10] Elementary school self-evaluation report „Miloš Crnjanski” Žabalj
- [11] Elementary school self-evaluation report „Đura Jakšić” Čurug
- [12] Elementary school self-evaluation report „Žarko Zrenjanin” Gospođinci



# Learning Data Mining Course Using Language R

C.M. Bande\*, A.Stojanova\*, N.Stojkovikj\*, M.Kocaleva\*, L.K.Lazarova\*, B. Zlatanovska\*

\*Faculty of computer science, “Goce Delcev” University, Stip, Republic of Macedonia  
cveta.martinovska@ugd.edu.mk, aleksandra.stojanova@ugd.edu.mk, natasa.stojkovik@ugd.edu.mk,  
mirjana.kocaleva@ugd.edu.mk, limonka.lazarova@ugd.edu.mk, biljana.zltanovska@ugd.edu.mk

**Abstract - Data mining, also known as knowledge discovery, is a process of discovering patterns and knowledge from large amounts of data, turning raw data into useful information. The data sources can be databases, data warehouses, the web, and other information repositories or data that are streamed into the system dynamically. Data mining course is crucial subject in computer science education. Finding proper tool for learning data mining is important in process in education. In this paper is considered programming language R, as a helping tool in process of learning data mining course. Some examples of machine learning algorithms implemented in R, are given.**

## I. INTRODUCTION

Data mining is a process which finds useful patterns from large amount of data. Today, we live in a world where vast amounts of data are collected every day. Analyzing such data is an important need. Data mining is a process that turns a large collection of data into knowledge. It makes use of complex mathematical algorithms to study data and then evaluate the possibility of events happening in the future based on the findings. Data mining is also referred to as knowledge discovery of data or KDD [1,2].

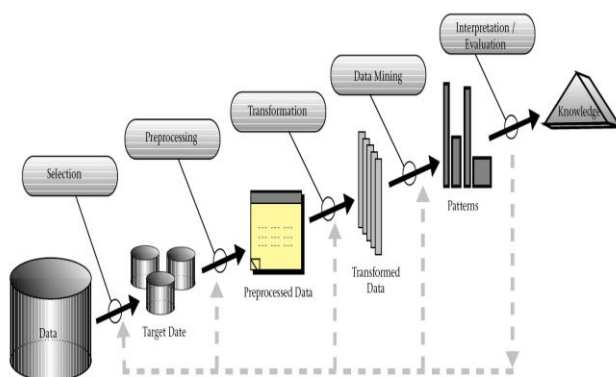

Figure 1. Knowledge discovering process

Data mining is usually used by businesses to draw out specific information from large volumes of data to find solutions to their business problems. It has the capability of transforming raw data into information that can help businesses grow by taking better decisions. Data mining has several types,

including pictorial data mining, text mining, social media mining, web mining, and audio and video mining amongst others [1, 3].

Types of data that can be mined are, data stored in the database, data warehouse, transactional data, and other types of data like, data streams, engineering design data, sequence data, graph data, spatial data, multimedia data, and more.

Data mining process can be useful in many areas like, healthcare, market analysis, customer relationship management (CRM), manufacturing engineering, finance and banking, education, etc.

Data mining can be with a great potential to transform the healthcare system completely. It can be used to identify best practices based on data and analytics. Therefore, it can help healthcare facilities to reduce costs and improve patient outcomes. Data mining, along with machine learning, data visualization, statistics, and other techniques can be used to make a difference. Data mining together with different techniques can be used for forecasting patients of different categories. This can help patients to receive intensive care when and where they want it. Data mining can also help healthcare insurers to identify fraudulent activities [4-8].

When data mining is used in area of market analysis it represents modelling technique that uses hypothesis as a basis. Retailers can use this technique to understand the buying habits of their customers. They also can use this information to make changes in the layout of their store and to make shopping a lot easier and less time consuming for customers [1,8].

CRM involves acquiring and keeping customers, improving loyalty, and employing customer-centric strategies. Every business need customer data to analyze it and use the findings in a way that they can build a long-lasting relationship with their customers. Data mining can be useful for them to do that.

A manufacturing companies depend on the data or information available to it. Data mining can help these companies in identifying patterns in processes that are too complex for a human mind to understand. They can identify the relationships that exist between different system-level designing elements, including customer data needs, architecture, and portfolio of products. Data mining can also prove useful in forecasting the overall time required for product development, the cost involved in the process, and the expectations companies can have from the final product.

Bankers can use data mining techniques to solve the banking and financial problems that businesses face by finding out correlations and trends in market costs and business information. This task can be very difficult without data mining as the volume of data that they are dealing with is too large. Managers in the banking and financial sectors can use this information to acquire, retain, and maintain a customer.

Use of data mining in education is still in its nascent phase. Data mining aims to develop techniques that can use data coming out of education environments for knowledge exploration. The purposes that these techniques are expected to serve include studying how educational support impacts students, supporting the future-learning needs of students, and promoting the science of learning amongst others. Educational institutions can use these techniques to not only predict how students are going to do in examinations but also make accurate decisions. With this knowledge, these institutions can focus more on their teaching pedagogy.

Considering all this mention earlier, data mining is useful process in many areas and its learning is crucial for helping many aspects of life. In this paper we first introduce data mining algorithms and techniques and later we concentrate on learning data mining using language R thru some useful examples [1,8].

## II. DATA MINING PROCESS, TECHNIQUES, AND ALGORITHMS

Three steps are involved in process of data mining, these steps are: Exploration, Pattern identification and Deployment. The first step is data exploration. In this step data is cleaned and transformed into another form, and important variables and therefore nature of data based on the problem are determined. When data is explored, refined and defined for the specific variables the

second step is performed. Second step is forming pattern identification. Identifying and choosing the patterns is crucial for making the best prediction. And at the end, patterns are deployed for desired outcome.

Before the actual data mining process could occur, there are several processes involved in data mining implementation [1,2 3].

First step is complete research of objectives, available resources, and requirements. That would help create a detailed data mining plan that effectively reaches the set goals. Next step is data quality checks. As the data gets collected from various sources, it needs to be checked and matched to ensure no bottlenecks in the data integration process. The quality assurance helps spot any underlying anomalies in the data, such as missing data interpolation, keeping the data in top-shape before it undergoes mining. The next step is data cleaning. It is believed that 90% of the time gets taken in the selecting, cleaning, formatting, and anonymizing data before mining. The next step is data transformation that can be divided in to 5 sub-stages: data smoothing, data summary, data generalization, data normalization and data attribute construction. In data smoothing process, noise is removed from the data. In data summary process the aggregation of data sets is applied. In data generalization process, the data gets generalized by replacing any low-level data with higher-level conceptualizations. In data normalization process data is defined in set ranges and in the data attribute construction process, the data sets are required to be in the set of attributes before data mining. The next step is data modeling process. Data modeling process is used for better identification of data patterns, several mathematical models are implemented in the dataset, based on several conditions [1,8].

Various algorithms and techniques like Classification, Clustering, Regression, Association, Artificial Intelligence, Neural Networks, Association Rules, Decision Trees, Genetic Algorithm, Nearest Neighbor method etc., are used for knowledge discovery from databases.

**Association** is one of the most used data mining techniques. In this technique, a transaction and the relationship between its items are used to identify a pattern. This is the reason this technique is also referred to as a relation technique. Association and correlation is usually to find frequent item set findings among large data sets. It can be used to conduct market analysis, which is done to find out

all those products that customers buy together on a regular basis. This technique is very helpful for retailers who can use it to study the buying habits of different customers. Retailers can study sales data of the past and then lookout for products that customers buy together. Then they can put those products in close proximity of each other in their retail stores to help customers save their time and to increase their sales. Association Rule algorithms need to be able to generate rules with confidence values less than one. However, the number of possible Association Rules for a given dataset is generally very large and a high proportion of the rules are usually of little value. Types of association rule are: Multilevel association rule; Multidimensional association rule; Quantitative association rule.

**Classification** is the most commonly applied data mining technique, which employs a set of pre-classified examples to develop a model that can classify the population of records at large. Fraud detection and credit-risk applications are particularly well suited to this type of analysis. Classification finds its origins in machine learning. It classifies items or variables in a data set into predefined groups or classes. It uses linear programming, statistics, decision trees, and artificial neural network in data mining, among other techniques. Classification is used to develop software that can be modelled in a way that it becomes capable of classifying items in a data set into different classes. The data classification process involves learning and classification. In Learning the training data are analyzed by classification algorithm. In classification test data are used to estimate the accuracy of the classification rules. If the accuracy is acceptable the rules can be applied to the new data tuples. For a fraud detection application, this would include complete records of both fraudulent and valid activities determined on a record-by-record basis. The classifier-training algorithm uses these pre-classified examples to determine the set of parameters required for proper discrimination. The algorithm then encodes these parameters into a model called a classifier.

There are different types of classification models, the most used ones are: Classification by decision tree induction; Bayesian Classification; Neural Networks; Support Vector Machines (SVM) and Classification Based on Associations.

**Clustering** can be said as identification of similar classes of objects. This technique creates meaningful object clusters that share the same

characteristics. By using clustering techniques, it can be identified dense and sparse regions in object space and can be discovered overall distribution pattern and correlations among data attributes. Clustering is often confused with classification, but if those two techniques are properly understood, it won't have any confuse. Unlike classification that puts objects into predefined classes, clustering puts objects in classes that are defined by it. Classification approach can also be used for effective means of distinguishing groups or classes of object but it becomes costly so clustering can be used as preprocessing approach for attribute subset selection and classification.

Some of types of clustering method are: Partitioning Methods; Hierarchical Agglomerative (divisive) methods; Density based methods; Grid-based methods; Model-based methods.

**Prediction** as data mining technique predicts the relationship that exists between independent and dependent variables as well as independent variables alone. It can be used to predict future profit depending on the sale, foe example. Regression technique can be adapted for predication. Regression analysis can be used to model the relationship between one or more independent variables and dependent variables. In data mining independent variables are attributes already known and response variables are what has to be predicted. Many real-world problems are not simply prediction. For example, sales volumes, stock prices, and product failure rates can be very difficult to predict because they can depend on complex interactions of multiple predictor variables. Therefore, more complex techniques (e.g., logistic regression, decision trees, or neural nets) may be necessary to forecast future values. The same model types can often be used for both regression and classification. For example, the CART (Classification and Regression Trees) decision tree algorithm can be used to build both classification trees (to classify categorical response variables) and regression trees (to forecast continuous response variables). Neural networks too can create both classification and regression models [5,6,7].

Types of regression methods that usually used are: Linear Regression; Multivariate Linear Regression; Nonlinear Regression; Multivariate Nonlinear Regression.

**Neural network** presents a set of connected input/output units, and each connection has a weight that corresponds with it. During the learning phase, network learns by adjusting weights, therefore the

network can predict the correct class labels of the input tuples. It represents the connection of a particular machine learning model to an AI-based learning technique. Since it is inspired by the neural multi-layer system found in human anatomy, it represents the working of machine learning models in precision. It can be increasingly complex and therefore needs to be dealt with extreme care. Neural networks could derive meaning from complicated or imprecise data and can be used to extract patterns and detect trends that are too complex to be noticed by either humans or other computer techniques. These are well suited for continuous valued inputs and outputs. Neural networks are best at identifying patterns or trends in data and well suited for prediction or forecasting needs. The most used neural network is Back Propagation.

### III. R LANGUAGE

R is a system for statistical analyses, graphics representation and reporting created by Ross Ihaka and Robert Gentleman at the University of Auckland, New Zealand, and is currently developed by the R Development Core Team. R is both a software and a language considered as a dialect of the S language created by the AT&T Bell Laboratories. R is freely available under the GNU General Public License, and pre-compiled binary versions are provided for various operating systems like Linux, Windows and Mac [9, 10].

The core of R is an interpreted computer language which allows branching and looping as well as modular programming using functions. R allows integration with the procedures written in the C, C++, .Net, Python or FORTRAN languages for efficiency.

R is available in several forms: the sources (written mainly in C and some routines in Fortran), essentially for Unix and Linux machines, or some pre-compiled binaries for Windows, Linux, and Macintosh. The files needed to install R, either from the sources or from the pre-compiled binaries, are distributed from the internet site of the Comprehensive R Archive Network (CRAN) where the instructions for the installation are also available.

R has many functions for statistical analyses and graphics. The data can be also visualized immediately in their own window and can be saved in various formats (jpg, png, bmp, ps, pdf, emf, pictex, xfig; the available formats may depend on the operating system). The results from a statistical

analysis are displayed on the screen, some intermediate results (P-values, regression coefficients, residuals, . . .) can be saved, written in a file, or used in subsequent analyses.

The R language allows the user, for instance, to program loops to successively analyze several data sets. It is also possible to combine in a single program different statistical functions to perform more complex analyses.

R users may benefit from a large number of programs written for S and available on the internet, most of these programs can be used directly with R. R could seem too complex for a non-specialist because of its complexity. A prominent feature of R is its flexibility. Whereas a classical software displays immediately the results of an analysis, R stores these results in an “object”, so that an analysis can be done with no result displayed. The user may be surprised by this, but such a feature is very useful. Indeed, the user can extract only the part of the results which is of interest. For example, if one runs a series of 20 regressions and wants to compare the different regression coefficients, R can display only the estimated coefficients: therefore, the results may take a single line, whereas a classical software could well open 20 results windows.

The following are the important features of R:

- R is a well-developed, simple and effective programming language which includes conditionals, loops, user defined recursive functions and input and output facilities.
- R has an effective data handling and storage facility,
- R provides a suite of operators for calculations on arrays, lists, vectors and matrices.
- R provides a large, coherent and integrated collection of tools for data analysis.
- R provides graphical facilities for data analysis and display either directly at the computer or printing at the papers.

R is world's most widely used statistics programming language. It's the number one choice of data scientists and supported by a vibrant and talented community of contributors. R is taught in universities and deployed in mission critical business applications [9,10].

In this paper we are using R language in the process of learning data mining course.

#### IV. USING LANGUAGE R IN THE PROCESS OF LEARNING DATA MINING COURSE

We will consider only the decision tree algorithms for classification and regression because it has a number of advantages over classical approaches such as linear regression, logistic regression, or linear discriminant analysis.

Advantages of decision trees:

- Decision trees can be very easily explained to people.
- Decisions from decision tree are much closer to human decisions, compared to other classification and regression approaches.
- Trees can be displayed graphically, and easily interpreted by non-experts.
- Trees can easily handle quality predictors without creating dummy variables
- Disadvantages of decision trees:
- Trees usually do not have the same level of accurate prediction as other classification and regression approaches [11-13].

#### V. BUILDING A REGRESSION TREE

First step is importing data in language R. The "read.csv" function is used to import data into R. After performing the function, the data will be given to the variable. (*movie* in the example, Figure 2)

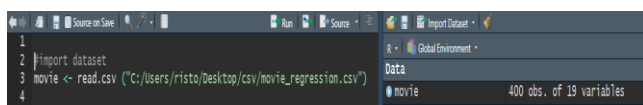

Figure 2.

The "View (name\_of\_variable)" function is used to view the data. After performing this function, a database will open in a new tab. The next step is data processing.

This step is also called lack of values. Which means if a value is missing in the database, that value must be replaced. This step is critical, because if there is a lack of value in the database, the models cannot be trained, i.e., R will not be able to perform the training functions of the model. This step is a mandatory step.

The summary (name\_of\_variable) command is performed, this function is used in order to make a summary of the data, i.e., to see if values are missing in any of the variables.

In the summary there are Min, 1rdQu, Meadian, Mean, 3rdQu, Max values. When a variable is missing a value, the NA's value appears.

In the Figure 3 is shown the summary of the variable *movie*. In the variable *Twitter\_hastgs*, NA's with a value of 8 appears, which means that in the variable *Twitter\_hastgs* there are 8 empty fields / values that need to be filled.

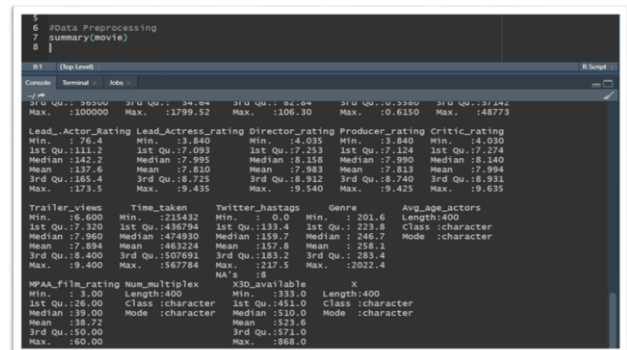

Figure 3.

NA's or empty fields need to be changed to a harmless value, such as Mean or Meadian. Which means the average value of the variable *Twitter\_hastgs* should be found, and that value should be inserted in the empty fields. The following code is used to perform that:

```
movie$Twitter_hastags[is.na(movie$Twitter_hastags)] <- mean(movie$Twitter_hastags , na.rm = TRUE)
```

The complete code for importing data set and data preprocessing is given below:

```
1. #import dataset
2. movie <- read.csv ("C:/Users/risto/Desktop/csv/movie_regression.csv")
3. View ( movie )
4. #Data Preprocessing
5. summary ( movie )
6. movie$Twitter_hastags[is.na(movie$Twitter_hastags)] <- mean(movie$Twitter_hastags , na.rm = TRUE)
7. summary(movie)
```

The next step is dividing data set into test and training set. This division is done in order to be seen the performance of the previously unknown data model. Usually, the data is shared between 80-20, which means that 80% of the data will be used to train the model, and 20% of the data will be used to test the model. A package called *caTools* is required to perform the division. First the package should be installed with *install.packages('caTools')* command,

and then started with `library(caTools)` command. After that, `set.seed(0)` command is used. By performing the `set.seed(0)` function, it is ensured that everyone will get the same data sharing.

Next, a new variable called `split` is created. This variable will be created based on the `movie` dataset, which means that it will have the same number of views as the `movie` dataset. The command `SplitRatio = 0.8` sets that 80% of the `split` variable will have a `TRUE` value, and the remaining 20% will have a `FALSE` value.

Whenever the value of the `split` variable is `TRUE`, which is almost 80% of the time, that value will be placed in the training set, and new variable `train` is obtained, by using the command:

```
train=subset(movie, split==TRUE)
```

And when the value of the `split` variable is `FALSE`, that value will be placed in the test set and new variable `test` is obtained, and new variable `train` is obtained, by using the command:

```
test=subset(movie, split==FALSE)
```

The complete code for obtaining training and test set is given below:

```
1. #Test-Train Split
2. install.packages('caTools')
3. library(caTools)
4. set.seed(0)
5. split = sample.split (movie , SplitRatio = 0.8)
6. train = subset(movie, split == TRUE)
7. test = subset(movie , split == FALSE)
```

For performing regression in R, first step is building a regression tree. In order to build a regression tree, some packages must first be installed. The `rpart` package is required to create a decision tree. The `rpart.plot` package is required to perform the plot.

The complete code for building regression tree is given below:

```
1. #install required packages
2. install.packages('rpart')
3. install.packages('rpart.plot')
4. library(rpart)
5. library(rpart.plot)
6. #Run regression tree model on train set.
7. regtree <- rpart ( formula = Collection~. , data = train , control = rpart.control(maxdepth = 3 ))
8. #Press F1 on rpart for help on this function
9. #Plot the decision Tree
```

```
10. rpart.plot(regtree, box.palette = "RdBu", digits = -3)
11. #Predict values at any point
12. test$pred <- predict(regtree , test , type = "vector")
13. MSE2 <- mean (( test$pred - test$Collection )^2)
```

After building and plotting a regression tree, values for other movies or for future watching are predicted (line 12).

In the next step, the Mean Square Error is calculated. In the next code line is the difference between the predicted values and the actual values, then the difference is squared and the mean value of all those values is found. This value is assigned to the variable `MSE2` (line 13).

Large decision trees with many nodes and many divisions are difficult to interpret and overcrowd the training set, leading to poor test set performance. In order not to have such problems, the growth of the tree should be controlled. Therefore, it can be decided before division to omit certain divisions, and this solution is called tree pruning. When working with pruning, many large trees are used, which are then shaped. The parts of the tree that are not needed are cut. The complete code of tree pruning in R is given below:

```
1. #Tree Pruning
2. fulltree <- rpart(formula = Collection~. , data = train , control = rpart.control(cp = 0))
3. rpart.plot(fulltree, box.palette = "RdBu" , digits = -3)
4. printcp(fulltree)
5. plotcp(regtree)
6. mincp <- regtree$scptable [which.min(regtree$scptable [ , "xerror"]) , "CP" ]
7. prunedtree <- prune(fulltree, cp = mincp)
8. rpart.plot(prunedtree, box.palette = "RdBu" , digits = -3)
9. test$fulltree <- predict(fulltree, test , type = "vector" )
10. MSE2full <- mean((test$fulltree - test$Collection)^2)
```

The only difference from the building a regression tree is the control parameter `cp`. Since `cp = 0`, the tree will grow like a normal tree, no pruning will be performed on this tree. And due to this control parameter, the maximum length of the tree will be obtained. Which means that the `fulltree` variable has total regression without constraints.

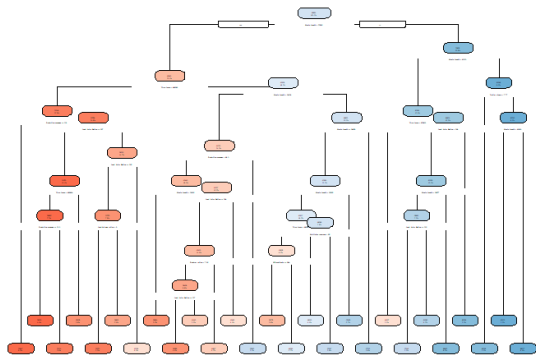

The relative error in the tree is changed with the value of *cp*. The `printcp(fulltree)` and `plotcp(regtree)` commands (line 4 and line 5) need to be performed in order to find the minimum relative error.

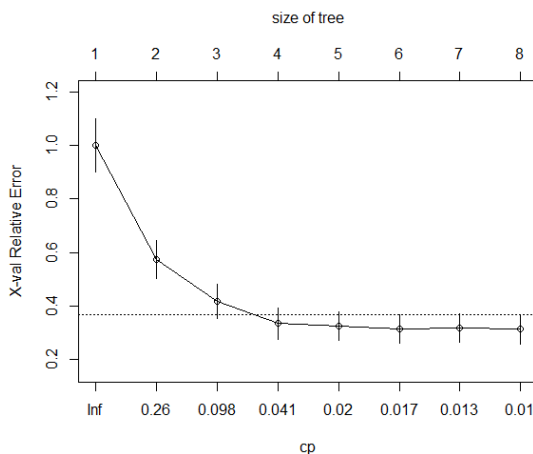
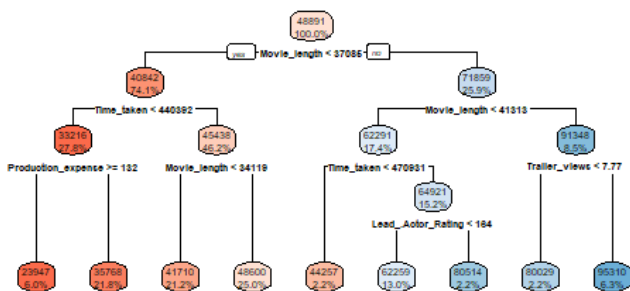

Figure 4. Finding the minimum relative error in regression tree

In order to find the specific value of *cp*, which cross-validated error is the minimum, line 6 command is performed. In this way a new variable *mincp* is created which has a value of almost 0.01. Using this value, the tree will be shaped (by performing pruning on the fulltree, line 7). When *prunedtree* is plotted (line 8) a small easy-to-read tree is obtained.



Next step is finding the value of MSE for fulltree, that will be done by using the predicted values (line 9 and line 10).

After obtaining the new variable *MSE2full*, the difference between MSE2, (Mean Square Error of regression tree) and *MSE2full* (Mean square error of whole tree) can be noticed. A decrease in MSE values can be observed.

The classification tree provides categorical variables, such as whether the film will win an Oscar or not. The output tree in the classification is similar to the tree in the regression, only there are a few small differences in the model and the backend.

In classification trees, *mode* is used to predict the model.

## VI. BUILDING A CLASSIFICATION TREE

The same code for regression can be used for classification. Only a few modifications need to be done. Code for Importing data set is the same (only new variable *moviec* is created and new csv file is used). The next steps are similar, Finding and filling in the missing values, Database division into test and training set, Installing the necessary packages and Building a classification tree.

The function of building a tree is *rpart*. The only change that needs to be made is to mention the *method* (`method='class'`). All other parameters are the same. A new variable *classtree* is obtained, which has all the necessary information about the classification tree. The *rpart.plot* function is used to plot the tree.

Next step is to predict the values for each position. The difference in this prediction function is the type parameter. Here, instead of the formula being equal to a 'vector' (regression), the formula will be equal to a 'class'. Later a comparison of the performance of the classification decision tree with the predicted values need to be done, and also the overall accuracy need to be checked.

The complete code for making classification in R is given below:

1. `#import dataset`
2. `moviec` <-
3. `read.csv("C:/Users/risto/Desktop/csv/classification file .csv", header = TRUE)`
4. `View(moviec)`
5. `#Data Preprocessing`
6. `summary(moviec)`
7. `moviec$Twitter_hastags[is.na(moviec$Twitter_hastags)]` <-
8. `mean(moviec$Twitter_hastags,na.rm=TRUE)`
9. `summary(moviec)`
10. `#Test-Train Split`

```
9. install.packages('caTools')
10. library(caTools)
11. set.seed(0)
12. split = sample.split (moviec , SplitRatio =
0.8)
13. trainc = subset(moviec, split == TRUE)
14. testc = subset(moviec , split == FALSE)
15. #install required packages
16. install.packages('rpart')
17. install.packages('rpart.plot')
18. library(rpart)
19. library(rpart.plot)
20. #Run classification tree model on train set.
21. classtree<-
rpart(formula=Start_Tech_Oscar~,data=trainc,method='class',control=rpart.control(max
depth = 3))
22. #Plot the decision Tree
23. rpart.plot(classtree, box.palette = "RdBu",
digits = -3)
24. #Predict values at any point
25. testc$pred <- predict(classtree , testc , type
= "class")
```

## VII. CONCLUSION

Data mining is very useful technique in many areas of life which need processing of large amount of data. Data mining has wide application domain almost in every industry where the data is generated that's why data mining is considered one of the most important frontiers in database and information systems and one of the most promising

interdisciplinary developments in Information Technology. Therefore, learning and understanding data mining is crucial to deal with new challenges. In this paper we presented language R as language that could be used for easily learning and understanding data mining course, with giving some examples that represent the basis of data mining.

## REFERENCES

- [1] Bharati, M., & Ramageri, M. (2010). Data mining techniques and applications.
- [2] Han, J., Pei, J., & Kamber, M. (2011). *Data mining: concepts and techniques*. Elsevier.
- [3] Lei-da Chen, T. S., & Frolick, M. N. (2000). Data mining methods, applications, and tools. *Information systems management*, 17(1), 67-68.
- [4] Jiawei Han and Micheline Kamber (2006), *Data Mining Concepts and Techniques*, published by Morgan Kaufman, 2nd ed.
- [5] Tan, P. N., Steinbach, M., & Kumar, V. (2013). Data mining cluster analysis: basic concepts and algorithms. *Introduction to data mining*, 487-533.
- [6] Weiss, S. M., & Indurkha, N. (1998). *Predictive data mining: a practical guide*. Morgan Kaufmann.
- [7] Rokach, L., & Maimon, O. (2005). Decision trees. In *Data mining and knowledge discovery handbook* (pp. 165-192). Springer, Boston, MA.
- [8] Rohit Sharma (2021) *Data Mining Techniques: Types of Data, Methods, Applications* ([https://www.upgrad.com/blog/data-mining-techniques/#18\\_Neural\\_Networks](https://www.upgrad.com/blog/data-mining-techniques/#18_Neural_Networks))
- [9] Paradis, E. (2005). *R for Beginners* (pp. 37-71). Institut des Sciences de l'Evolution. Université Montpellier II.
- [10] R Programming Language – Tutorialspoint [https://www.tutorialspoint.com/r/r\\_tutorial.pdf](https://www.tutorialspoint.com/r/r_tutorial.pdf)
- [11] Alison : Machine Learning and Decision Trees <https://alison.com/topic/learn/114685/simple-classification-tree#course-plan>
- [12] JIGSAW ACADEMY <https://www.jigsawacademy.com/blogs/data-science/decision-tree-in-machine-learning/>
- [13] Rstudio <https://www.rstudio.com/products/rstudio/>



# Agent-based Modelling and Simulation

N.Stojkovicj\*, A. Stojanova\*, L. K. Lazarova\*, M. Miteva\*

\* Goce Delcev University/Faculty of Computer Science, Stip, Republic of North Macedonia  
natasa.stojkovicj@ugd.edu.mk; aleksandra.stojanova@ugd.edu.mk; limonka.lazarova@ugd.edu.mk;  
marija.miteva@ugd.edu.mk.

**Abstract** -One of the most important methods in the educational process, is modelling and simulation of real-world problems. In many situations it is not possible to experiment with real objects to find the right solutions: building, destroying, and making changes may be too expensive, dangerous, or just impossible. Modelling and simulation can be used to build model to represent the real system.

Agent based modelling is a relatively new method compared to system dynamics and discrete event modelling. That are computer simulations used to study the interactions between people, things, places, and time. The agents are programmed to behave and interact with other agents and the environment in certain ways.

In this paper, the agent-based modelling simulation is considered. In simulation software Anylogic are given some examples of agent-based modelling.

## I. INTRODUCTION

The modelling and simulation can be used for building models in order to represent the real systems. A simulation is the imitation of the operation of real-world process or system, over the time. In many cases, when it is not possible to experiment with real system for finding the solution, the simulation models are used. For example, building, destroying, and making changes may be too expensive, dangerous, or just impossible. In this case, it is better to build model that uses modelling language to represent the real system.

On the one side, a model should be a close approximation on the real system, and it should contain the most of its important features. On the other side, the model should be simpler for understanding and experimenting, [1], [2].

The simulation modeling is appropriate tool in the following cases [2]:

- when the problem can not be solved analytically.
- Simulation allows the study of internal interaction of subsystems in the complex system.
- Informational, organizational and environmental changes can be simulated in

order to be seen their affect in the real system.

- By changing of the simulation inputs and observing of the resulted outputs, can be determined which variables are important and how those variables affect on the system.
- Verification of analytical solution.
- A plan can be visualized with animated simulation.
- Simulation models designed for training make learning possible without incremeting of the cost.

The simulation of the models has advantages and disadvantages. The advantages of the simulation refer to the operations in the real system which are not interrupted, and not used real resources. Also, the time can be compressed or expanded to allow speed-up or slow-down of the phenomenon. In the simulation the variables are controlled. It also provides testing of the hypothesis about why and how certain phenomena are occurred. In the simulation questions in the form “What if” questions can be asked with obtaining appropriate answers. The disadvantages of simulation are that the building of the model requires special training. The obtained simulation’s results often are difficult for interpretation. The process of simulation can be long and expensive because many simulations require special software which have output analysis, [2],[4].

The main aim of the simulation modelling is creation of the framework in which by using of methods we map a real-world system to its model. There are three methods in simulation modelling:

- System Dynamics
- Discrete Event Modeling
- Agent Based Modeling, [5].

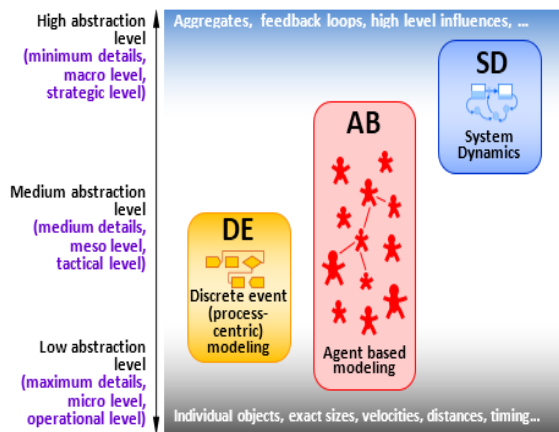

Fig 1. Methods in simulation modeling

Each method has a specific range of abstraction levels. System dynamics assumes very high abstraction, and it is typically used for strategic modeling. Discrete event modeling supports medium and medium-low abstraction. Agent-based modeling does not assume any particular abstraction level. Agent based models, can vary from very detailed models where agents represent physical objects to the highly abstract models where agents represent competing companies or governments.

The selection of the simulation method should be appropriate to the goals of modeling and the system which is subject of the analysis. At the Figure 2 is shown how the modelers are deciding which is the best way to build a model of a supermarket. They can build a process flowchart where customers are entities and employees are resources, an agent-based model where consumers are agents who are affected by advertising, communication, and their interactions with agents and employees, or a feedback structure where sales are in the loop with ads, quality of service, pricing, and customer loyalty. But the best way to model the different parts of a system is the modeling when the different methods are used, and in these situations a multi-method model will best meet the needs.

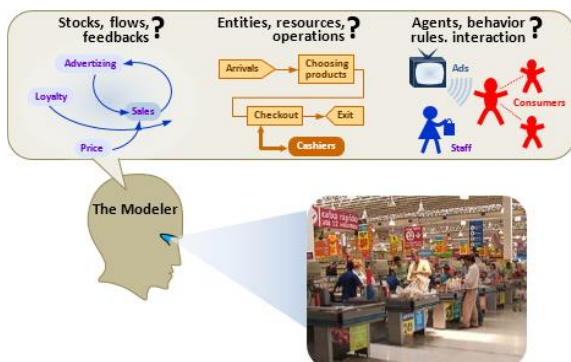

Fig 2. The modeler chooses a modeling method

In this paper we are considering the agent-based simulations and their application in the educational process. It will be shown how the agent-based simulation methods can help in the process of modelling. This refers especially for the students at the mathematical study programmes and computer sciences who study the subjects related to the mathematical modeling, in order to understand the basic concepts for creation of simulation model. The models which are described in this paper, are done in AnyLogic Simulation Modeling Software. This software was primarily chosen because of the availability of ready basic models and its simplicity. In this paper we will describe simple mathematical models like cinema model, SIR epidemiological model and model for transport system. With studying of these simple models, the students can easily understand the basic concepts of agent-based simulations in order to obtain the agents, their activities and mutual communications between the agents.

## II. AGENT BASED MODELLING

Agent based modeling is a relatively new method in comparison with system dynamics and discrete event modeling. In fact, agent-based modelling, firstly was accepted as an academic topic. The adoption of agent-based modeling by simulation practitioners started in 2002-2003.

It was triggered by:

- A desire to gain deeper insights into systems because traditional modeling approaches do not capture well.
- Advances in modeling technology make possible modeling by computer science, such as object oriented modeling, UML, and state charts.
- The rapid growth of CPU power and memory. Agent based models are more demanding models than system dynamics and discrete event models.

Agent based modeling offers a modeler another way to look at the system:

With this modeling it is known how the system behaves, which are the key variables and their dependencies, how the process flows, and how the system's objects behave. So, the building of this kind of model is starting by identifying the objects (agents) and defining their behaviors. Afterward, it is needed to make connections between the agents which are created and allow them to interact or put them in an environment which has its own

dynamics. The system's global behavior emerges from many (tens, hundreds, thousands, millions) concurrent individual behaviors.

There is no standard language for agent-based modeling, and an agent-based model's structure comes from graphical editors or scripts. In agent-based modeling a system is modeled as a collection of decision-making entities called agents. The agent evaluates its situation and makes decisions on the basis of certain rules. There are many ways to specify an agent's behavior. They may execute various behaviors appropriate for the system.

In many cases, the best way to capture the agent's internal dynamics is to use system dynamics or a discrete event approach, and then place a stock and flow diagram or a process flowchart inside an agent. Similarly, outside agents the dynamics of the environment where they live is often naturally modeled using traditional methods. It is why many agent-based models are multi-method models.

Agents in an agent-based model may represent very diverse things: vehicles, units of equipment, projects, products, ideas, organizations, investments, pieces of land, people in different roles, etc.

Academics still debate which properties an object should have to be an "agent": proactive and reactive qualities, a spatial awareness, an ability to learn, social ability, "intellect", etc. In applied agent-based modeling, however, all kinds of agents are present: some communicate while others live in total isolation, some live in a space while others live without a space, and some learn and adapt while others never change their behavior patterns.

The advantage of agent-based modeling over other modeling techniques can be captured in three statements: Agent based modeling captures emergent phenomena, it allows a natural description of the system and its flexible.

### III. AGENT BASED MODELLING IN MATH MODELING COURSES

With advances in computing, agent-based modelling has become a feasible and appealing tool for studying of different systems. Agent based modeling are used as powerful modeling tool for modeling of stochastic processes, for modelling of process that involve nonlinear interaction and heterogeneous spatial structures.

Agent-based modeling has been used for studies in economics, biology, political science, business and management, medicine etc.

The inclusion of agent-based modelling in math courses generally are performed in two ways. The first way is when the agent-based modelling is studied as one modeling technique in a course that contains more modeling techniques, the second way is when exist the special course of agent-based modeling, and in this course the agent based modeling is the only type of modeling that is used.

The formal description of an agent-based model requires more than just writing of the computer code. This can be problem for many students from computer science and math. Often description of the simple agent-based model is not easily and require more time and labor. This can make, agent-based modeling to look difficult for the students when they are starting with the study of agent-based models.

In the courses for modeling and simulation, the professors should take care not to introduce the computer code implementation simultaneous to the model description. Courses for studying methods in mathematical modeling must start with a discussion of the modeling cycle, which can be presented as a flow diagram, representing it as a mathematical model, analyzing the model and then using the results for next tasks. On the Figure 3 example of a modeling cycle diagram is represented. [7].

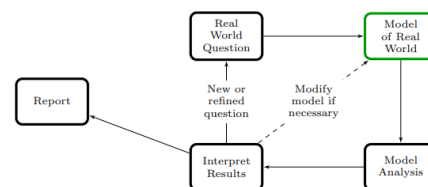

Fig 3. Diagram of the modeling cycle

When the mathematical models are represented with equations (more often differential equations), the time spent on representing the real world as a mathematical model is relatively short. The building of an agent-based model can be a long process, because the models are designed to simulate interactions between individuals and the local environment.

When students are in the middle of constructing their first agent-based model, they often lose sight of where they are in the modeling cycle. Because the model implementation is one cycle, writing of the code is other cycle. After that, the students should test the code and if it runs and produces good results. This process should be repeated too slowly and add all the components needed for the full algorithm of the agent-based model.

There are many different software tools for constructing, simulating, and analyzing agent-based

modelling. When the agent-based modelling is used in mathematics courses software should be chosen according to the pedagogical objectives of the course.

Some of the most used simulation software in education are: EcoBeaker, SimBio, NetLogo and Anylogic.

NetLogo is a multi-agent modeling environment. This software is used by many hundreds of thousands of students, teachers, and researchers from whole world. Its user interface includes a tab where agent-based modeling code is written in the NetLogo programming language, and a tab for the user to view a visualization of the model and user specified outputs as the model is simulated, [10].

EcoBeaker is an ecological simulation program designed primarily for education but also useful for research models. EcoBeaker makes a two-dimensional computer world into which the agents are placed and their behaviors are designed, [8].

SimBio is a simulation software for biological systems such as cardiac cells, epithelial cells, and pancreatic  $\beta$  cells. With this software can be simulated experiments in evolution, cell biology, genetics, and neurobiology. SimBio is written in Java, uses XML and can solve ordinary differential equations, [9].

AnyLogic is a simulation modeling tool developed by AnyLogic (formerly XJ Technologies). It supports agent-based simulation, discrete events simulation, and system dynamics. AnyLogic is a cross-platform simulation software running on Windows, macOS and Linux.

AnyLogic is used to simulate markets and competition, healthcare, manufacturing, supply chain and logistics, retail, business processes, social and ecosystem dynamics, defense, asset management, pedestrian dynamics, and road traffic, [11].

We will consider some examples where AnyLogic software is used.

#### IV. CASE STUDY IN ANYLOGIC

##### A. Seir Model

SEIR model is the most effective model for explaining how an epidemic is spreading. The SEIR model is consisting of the assumption for totally susceptible population at the starting time of the pandemic. In the SEIR model, the global population of  $N$  individuals are split in 5 categories: *susceptible*  $S$ , *exposed*  $E$ , *infected*  $I$  and *recovered*  $R$ .

- Susceptible - people who are not infected by the virus, the started population.
- Exposed - people who are infected but who can't infect others
- Infectious - people who are infected and who can infect others
- Recovered – people who have recovered from the virus.

In Anylogic, *stocks* represent real-world stocks of material, knowledge, people, money, etc. *Flows* define their rate of change - how stock values change and define the system's dynamics. The SEIR model in Anylogic is given on Figure 4.

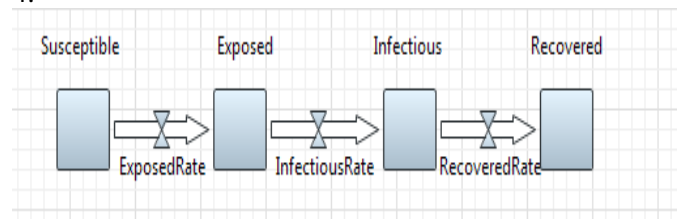

Fig.4 SEIR model in AnyLogic

AnyLogic automatically generates a stock's formula according to the user's stock-and-flow diagram. AnyLogic automatically created these formulas when the flow is added.

After that, the parameters and dependencies are defined. Five parameters: Total Population, Infectivity, ContactRateInfectious, AverageIncubationTime, AverageIllnessDuration are added, and their default values are defined.

- Total Population=2000000
- Infectivity=0.3
- ContactRateInfectious=0.5
- AverageIncubationTime=10
- AverageIllnessDuration=10

Now, the number of infected people is defined by specifying 1 as the Initial Value of the stock Infectious and define the Initial Value for the stock Susceptible: TotalPopulation-1. ,

- ExposedRate=Infectious\*ContactRateInfectious\*Infectivity\*Susceptible/Total population
- InfectiousRate=Exposed/AverageIncubation Time
- RecoveredRate=Infectious/AverageIllnessDuration.

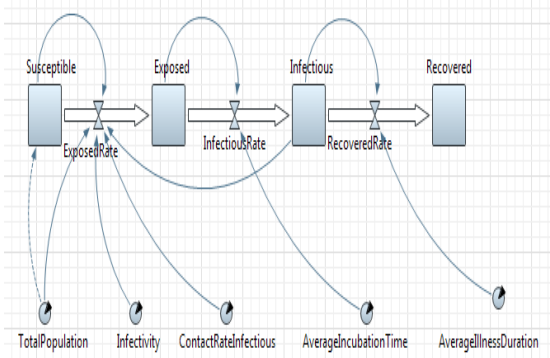

Fig5. SEIR model with parameters

We run the model, and the output is given on Figure 6

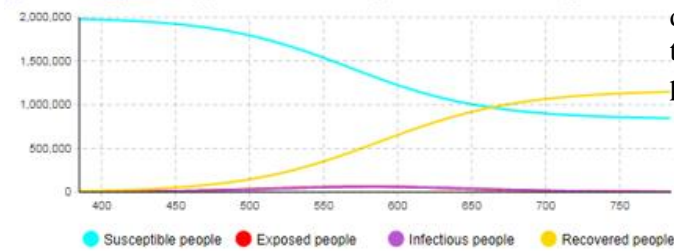

Fig 6. Output from SEIR model

**B. Cinema model**

An agent-based model of a customer cinema – one where each customer will be an agent will be built. The model includes 5000 people who have not seen one movie in the cinema, but a combination of advertising and word of mouth will eventually lead them to purchase the ticket to watch it. It is also represented advertising’s influence on consumer demand by allowing a specific percentage of them to become interested in purchasing the ticket during a given day. Advertising effectiveness = 0.1 determines the percentage of potential users that become ready to buy the product during a given day.

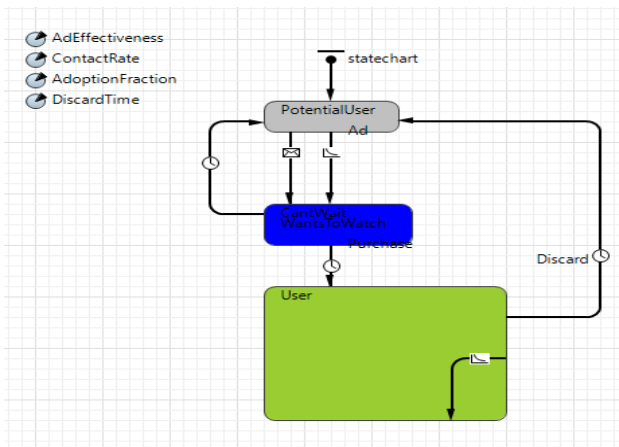

Fig 7. Cinema model

The parameters that are included represent several functions, the first parameter AdEffectiveness defines the percentage of potential users who become ready to buy the ticket and watch the movie during a given day. The second ContactRate represent how many contacts of a person has per day with other PotentialUsers. The third AdoptionFraction is used to show how much the ContactRate (the contact between two PotentialUsers) has affection. The last parameter on the picture represents DiscardTime, how much time will the User wait to become PotentialUser again.

There are two more parameters which test the impatience of our customers. MaxWaitingTime defines the maximum time a consumer will wait for the product (in this case, 15 minutes) and the other parameter, MaxPurchaseTime is 20 minutes.

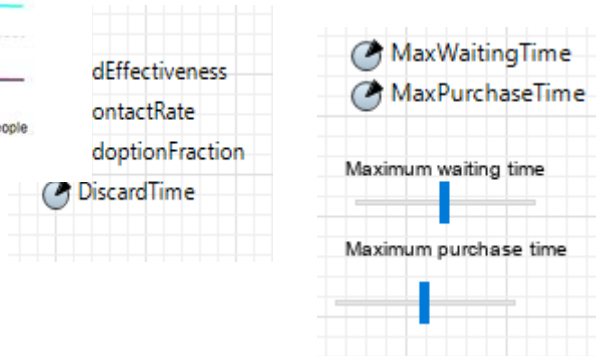

Fig.8 Parameters in Cinema Model

When program is run, 5000 population that is selected above, is obtained and it can be seen that mostly have gray Potential Users because the patience is very low and the max waiting time in our case is 20minutes. The yellowGreen which are the Users are less and when they finished with the watching of the movie, they cannot go back for another 7 days.

Cinema model simulates how 5000 people will react if they all are PotentialUsers and waiting to purchase one ticked for the one movie in the Cinema. From the last picture it can be concluded that because 5000 people is too many for just one selling counter and the waiting line is too long, which means that the customers will have high impatience and most of them won't be waiting, and they will eventually quit and go back to PotentialUsers. So, if is needed to sell tickets to 5000 people, more than one selling counter is needed, therefore the waiting line won't be so long, and the people will not wait to purchase the ticket.

The output from simulation in given on Figure 9

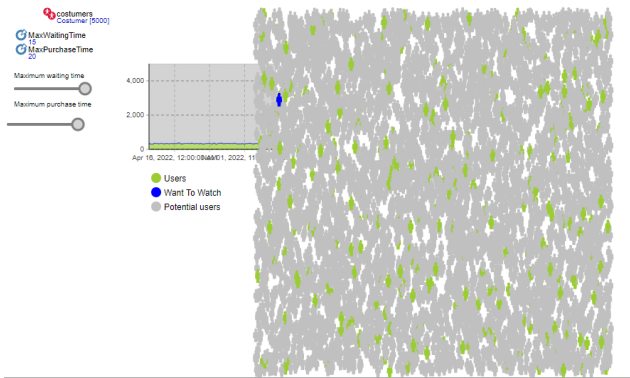

Fig.9 Output from Cinema model

## V. CONCLUSION

Agent-based modeling and simulation is a powerful technique in simulating and exploring phenomena that includes a large set of active components represented by agents. Also, agent-based models offer an extensible way to model different systems consisting of autonomous and interacting agents which perform their actions and adapt their behaviors. The computer simulation in AnyLogic software helps the researcher to explore the behavior of a dynamic system. In this paper, we discussed the broad applications of agent-based modeling and simulation.

Because the use of ICT is increasing in all aspects of life as well as the need to optimize different systems and processes using computer models and simulations, in which intelligent agents play a key role, the use of agent-based modeling and simulation tools in education is justified. The paper also outlines the essential features of agent-based tools that, according to our experience, can play a key role in choosing one of them. That is why we believe this paper can be used by the teachers at all levels

of the education system when choosing the most appropriate tool for their work.

## REFERENCES

- [1] A. Maria, "Introduction to Modeling and Simulation," *Phil. Trans. Roy. Soc. London*, vol. A247, pp. 529–551, 1997.
- [2] J. Banks, J. S. Carson, and B. L. Nelson, *Discrete-Event System Simulation*, Second Edition, Prentice Hall, 1996.
- [3] J. M. Aughenbaugh, C. Paredis, *The Role and Limitations of Modeling in Systems Design*, Proceedings of IMECE2004, ASME International Mechanical Engineering Congress and RD&D Expo November 13-19, 2004, Anaheim, California USA.
- [4] G. L. Fenves, F. McKenna Axel, *Data Model for Simulation*, 2010.
- [5] A. Borshchev, I. Grigoryev, *The Big Book of Simulation Modeling MultiMethod Modeling with AnyLogic 8*, 2020.
- [6] E. Bonabeau, "Agent Based Modeling: Methods and Techniques for Simulating Human Systems", Proceedings of the National Academy of Sciences of the United States of America, Vol. 99, No. 10, Supplement 3: Sackler Colloquium on Adaptive Agents, Intelligence, and Emergent Human Organization: Capturing Complexity through Agent-Based Modeling (May 14, 2002), pp. 7280-7287.
- [7] E. N. Bodine, R. M. Panoff, E. O. Voit, A. E. Weisstein, "Agent-based Modeling and Simulation in Mathematics and Biology Education", *Bulletin of Mathematical Biology* volume 82, Article number: 101 (2020).
- [8] E. Meir, *EcoBeaker 2: Teaching Ecology and Conservation Through Computer Experiments*, Proceedings, University of Washington, USA, EdMedia+Innovative Learning, Association for the Advancement of Computing in Education (AACE), Waynesville, NC, 1999.
- [9] M. Behr, M. Llari, *SIMulation technologies in the fields of BIO-Sciences and Multiphysics: BioMechanics, BioMaterials and BioMedicine*, Marseille, France, June 2014.
- [10] <https://ccl.northwestern.edu/netlogo/>
- [11] A. Borshchev, "MultiMethod Modeling: AnyLogic Chapter", In book: *Discrete-Event Simulation and System Dynamics for Management Decision Making*, April 2014.

# Using WEKA for Finding Output for Given Function

M. Kocaleva\*, B. Zlatanovska\*, E. Karamazova\*, N. Stojkovikj\*, A. Stojanova\*

\*Faculty of computer science, “Goce Delcev” University, Stip, Macedonia  
mirjana.kocaleva@ugd.edu.mk, biljana.zlatanovska@ugd.edu.mk, elena.gelova@ugd.edu.mk,  
natasa.maksimova@ugd.edu.mk, aleksandra.stojanova@ugd.edu.mk

**Abstract** - The aim of this paper is to explain what a machine learning is and to describe a decision tree as a kind of implementation of machine learning. Also, in the paper will be shown the practical application of Waikato Environment for Knowledge Analysis (WEKA) through a concrete example. WEKA is one of the most used software for machine learning. The example consists of a function of three input data giving the appropriate output. The function is shown with two types of decision trees: MSP and PERTree. In the conclusion is presented the appropriate and best output for our function.

## I. INTRODUCTION

Machine learning is a branch of artificial intelligence and scientific discipline that deals with the design and creation of algorithms that allow computer systems to improve their work with the help of empirical data, i.e., data obtained through mechanical sensors, database, etc., through experiments and observation [1], [2]. Machine learning is the science of making computers work without being explicitly programmed. Over the past decade, machine learning has given us self-driving cars, practical speech recognition, web browsing, and significantly improved understanding of the human genome.

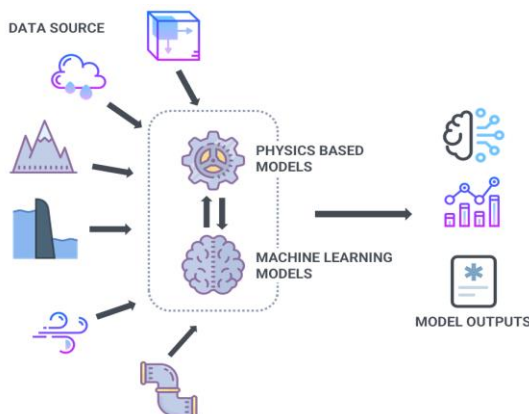

Figure 1. Machine learning model [8]

Machine learning is so prevalent today that everyone probably uses it dozens of times a day without knowing it. Many researchers also think that this is the best way to make progress on AI at the

human level [9]. The field of machine learning requires an answer to how to create a computer system that improves its work from the experiences gained during its existence and operation, as well as to what are the fundamental laws that characterize the learning processes. These questions cover a wide range of learning tasks that contribute to many areas of real life, for example: the design of an autonomous mobile robot that learns to maneuver in the space in which it is located with the help of its experience, data mining of medical records of diseased patients in aim to study diagnoses for newly - ill patients, a search engine that automatically adapts to the needs of its users [3], [4].

There are several algorithms of machine learning implementation [5], [6] and they are listed below:

1. Decision tree - This way of learning uses a decision tree as a predicate model. It is one of the predictive modeling approaches used in statistics, data mining and machine learning. More descriptive names for the models are classification trees or regression trees. In these tree structures, the leaves represent class labels and the branches are the connectors of the functions that lead to those class labels.
2. Rule of association - It is used as a learning method to discover the relationships between parameters in large databases.
3. Artificial neural networks - Artificial neural networks are a learning algorithm that is inspired by the structure and functional aspect of the biological neural network. The calculations are structured in relation to interconnected groups of artificial neurons that are divided into layers and each layer makes a certain change in the input parameters. There are three major groups of neurons: input neurons, hidden neurons, and output neurons.

4. Genetic programming - Genetic programming is an algorithmically based evolutionary methodology inspired by biological evolution to find computer programs that perform user-defined tasks. It specializes in genetic algorithms where each individual is a computer program. This technique is used to optimize the population of computer programs according to the rule of suitability determined by the ability of the program to perform a given task.
5. Inductive logic programming - Inductive logic programming is a way of learning that uses logical programming as a uniform representation of examples, basic knowledge, and hypotheses. By applying a basic knowledge of a particular problem and a set of examples presented as a logical database of facts, this way of learning tries to derive a hypothesis in the form of a logical program that includes all positive but not negative examples.
6. Support vector machine - Support vector machines are a set of related supervised learning methods that used classification and regression. For a given set of training examples, each of the examples is marked as belonging to one of two categories. With the help of support vector machines, a model which predicts whether a given input example belongs to one or another category is made.
7. Clusters - Cluster analysis or also called clustering (grouping) is the division of a set of data into subsets called clusters so that all the observed data in a particular group is in some way similar in nature. Clustering is a method of unsupervised learning and a frequently used method for statistical data analysis.
8. Bayes networks - The Bayes network, also called the belief network, is a probabilistic graphical model representing a set of random variables and their conditional independences using a directional acyclic graph (DAG). For example, the Bayes network may represent the link between certain diseases and symptoms. If the symptoms are known, the network can be used to calculate the likelihood of the presence of one of the various diseases. There are efficient algorithms that use the Bayes network to extract knowledge about certain problems.

## II. DECISION TREE

This way of learning uses a decision tree as a predicate model. It is one of the predictive modelling approaches used in statistics, data mining and machine learning. More descriptive names for the tree models are classification trees or regression trees. In these tree structures, the leaves represent class labels, and the branches are the connectors of the functions that lead to those class labels.

The decision tree is a method for approximation of discrete - value target functions, in which the function is represented by a decision tree.

Trees can also be represented as sets of if-then rules to improve human readability. Decision trees consist of deciding nodes, where each deciding node is double or multiple branched, with each branch representing the value of the attribute being tested. The leaves are no longer branched, and they are generators of a uniform (final) conclusion.

Each decision tree starts with a node that represents the so-called initial decision, from where the branching of the tree begins. In Figure 2, the node representing the initial decision is presented by a square. The leaves generate the result if a specific path is followed along the stem.

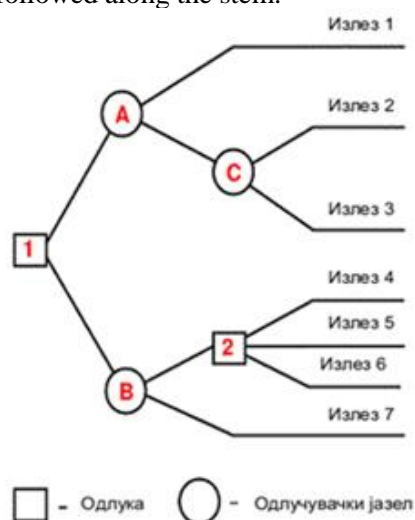

Figure 2. Decision tree

## III. DECISION TREES TECHNIQUES

Specific decision tree methods include Classification and Regression Trees (CART) and Chi Square Automatic Interaction Detection (CHAID). CART and CHAID are decision tree techniques used for database classification. They provide a set of rules that can be applied to new (non-classified) databases to predict which records will have a given outcome. CART usually requires less data preparation than CHAID.



The decision tree is a method similar to the learning concepts that use a system and an ID3 algorithm that generates a rule, i.e. a classification tree for a given concept with its attributes and their values. Its inductive bias is an advantage over most small trees, and it is able to classify disjunctive concepts as well. This method may be far more effective than other inductive learning systems, but it is also not applicable in some complicated domains.

Decision tree learning is a type of function for approximating (discrete values) attributes and their discrete values. The decision tree classifies samples by accepting attributes from the root to the leaf of a branch, and can also be seen as a list of if-then rules (each branch is a conjunctive relation of attributes, and the whole tree is a disjunction). Example [7] tree for the PlayTennis concept (Figure 3):

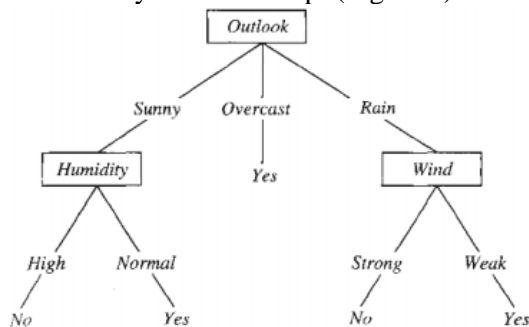

Figure 3. Decision tree for the PlayTennis concept

which represents the expression:

$(\text{Outlook} = \text{Sunny}) \wedge (\text{Humidity} = \text{Normal})$

$\vee (\text{Outlook} = \text{Overcast})$

$\vee (\text{Outlook} = \text{Rain} \wedge \text{Wind} = \text{Weak})$

As can be seen, the samples are represented by a list of attribute-value pairs, the target function in the example is Boolean, but can be extended to a discrete or even real function. The instances in the example may contain errors (either in the attribute values or in the classification) or undefined attribute values.

#### IV. PROBLEM IMPLEMENTATION IN WEKA

WEKA is a machine learning / data mining software written in Java used for research, education, and applications. Its main features are:

- Comprehensive data set on processing tools, learning algorithms, and evaluation methods (Figure 4).
- Graphical user interfaces (including data visualization).

- Environment for comparing learning algorithms.

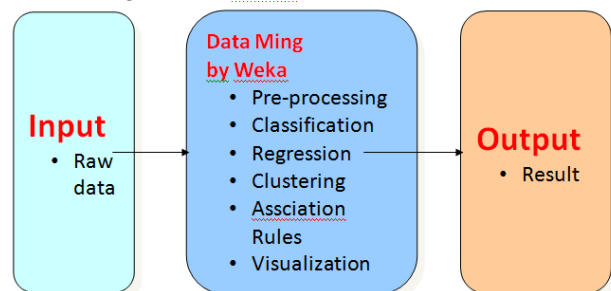

Figure 4. How WEKA work (Data processing in WEKA)

The following methods are implemented in Weka:

- Bayes
- Decision trees and rules
- Neural networks
- Functions
- Meta, lazy classifiers ...

With the following test options:

- Use a training set
- Cross validation
- Percentage split.

WEKA works with files in ARFF format (Attribute-Relation File Format) which is an ASCII text file that describes a list of instances that share a common set of attributes (Figure 5).

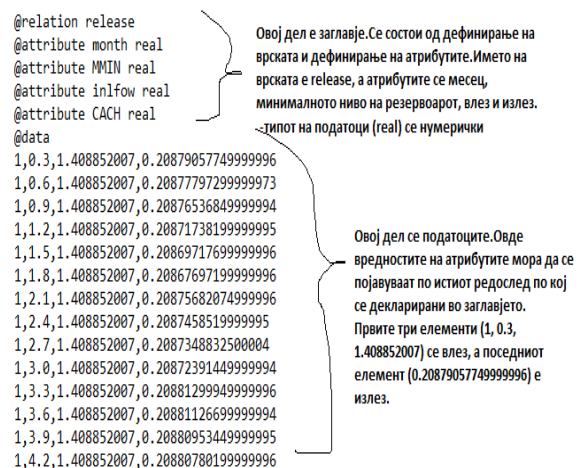

Figure 5. An Attribute-Relation File Format

#### Input parameters

The input data has the following structure:

```
@relation release
@attribute month real
@attribute MMIN real
@attribute inflow real
@attribute CACH real
@data
```

jan,0.3,1.408852007,0.20879057749999996

jan,0.6,1.408852007,0.20877797299999973  
jan,0.9,1.408852007,0.20876536849999994

Our task and main goal were to examine which of the methods in WEKA is the best for presenting the function:

$$\text{release} = f(\text{month}, \text{MMIN}, \text{inflow})$$

- We performed the tests using the test option "Use a training set"
- We examined with M5P and REPTree decision trees

M5P is reconstruction of Quinlan M5 algorithm to encourage tree models for regression. M5P combines conventional decision trees with the possibility of linear node regression functions. All attributes are converted to binary variables, so all partitions in M5P are binary. M5P generate models that are compact and relatively understandable.

REPTree makes reduced-errors and counts all attributes. Builds a decision / tree of regression with the help of entropy as a measure of uncertainty and using information obtained with the criterion of separation. REPTree is a fast decision tree and sort values for numeric attributes only.

Results from examination with decision trees are given in the table below (Table 1):

Table 1. Decision tree results

Decision tree		
	M5P	PERTree
<b>Size of the tree</b>	1194	3675
<b>Number of Rules</b>	598 (3588 lines code)	
<b>Correlation coefficient</b>	0.9609	0.983
=== Summary ===		
<b>Mean absolute error</b>	0.2339	0.1076
<b>Root mean squared error</b>	0.518	0.3422
<b>Relative absolute error</b>	16.4167 %	7.5535 %
<b>Root relative squared error</b>	27.792 %	18.3613 %
<b>Total Number of Instances</b>	<b>36960</b>	

## V. CONCLUSION AND DISCUSSION

According to the results given in the table above, we conclude that with REPTree we have a lower relative absolute error than with M5P. And that relative absolute error is 7.5535%. So, REPTree gave us the best output for this function, despite the size of the tree.

Our next aim is to compare decision trees with artificial neural networks algorithm and to see which technique will give us a better result.

## REFERENCES

- [1] Anjan.K, Harish.R. (2013). Machine Learning with WEKA.
- [2] Awadhesh, I. (2012). WEKA - IT For Business Intelligence. Term Paper , 17.
- [3] Gupta, S. (2009). Term paper on Data mining - How to use Weka for data analysis.
- [4] Pfahringer, B. (2013). Machine Learning with WEKA. New Zealand: University of Waikato.
- [5] Kocaleva, Mirjana and Martinovska Bande, Cveta (2017) Споредба на алгоритми за класификација. Yearbook of the Faculty of Computer Science, 5 (4). pp. 27-36. ISSN 1857- 8691
- [6] Zoran, P. (2007). Seminarski rad:Masinsko ucenje, inteligentni agenti. Univerzitet u Beogradu.
- [7] Quinlan, J.R. Induction of decision trees. Mach Learn 1, 81–106 (1986). <https://doi.org/10.1007/BF00116251>
- [8] DHI research and innovation, Machine learning, <https://research.dhigroup.com/machine-learning/>
- [9] Machine Learning by Stanford University | Coursera, <https://www.coursera.org/learn/machine-learning>

# Analysis of the Representation of Object-Oriented Programming Languages in Primary Education

A. Mamić\*, M. Blagojević\*, T. Đuričić\*\*

\* University of Kragujevac, Faculty of Technical Sciences, Cacak, Serbia

\*\*Primary school Petar Kočić, Indija, Serbia

acomamic@gmail.com, marija.blagojevic@ftn.kg.ac, tijanadjuricic86@gmail.com

**Abstract - This paper presents an analysis of the curriculum for primary school in the subject of Informatics and Computing. The focus is on the field of programming and object-oriented programming languages. The analysis established the curriculum for teaching and learning in the subject of Informatics and Computing, which is extremely dedicated to the development of programming skills in students, from the aspect of the number of classes in which it is studied and the defined learning outcomes. It was also stated that students develop their skills by applying two object-oriented programming languages, namely Scratch and Python, and that for the introduction of the third it is necessary to increase the number of classes in the subject of Informatics and Computing. At the very end, the necessity of paying attention to this issue within the Strategy for the Development of Education until 2030 was emphasized.**

## I. INTRODUCTION

Programming has been one of the most attractive and paid jobs in the field of IT sector for many years. People of various ages, interests and educational profiles are involved in programming. Regardless of the level acquired and the type of formal qualifications, programming skills can be mastered through the informal domain of education, such as various courses and trainings, or independently with online tutorials. Research shows that in 2020, knowledge from the programming languages JavaScript, Java, PHP, Python, C # and C ++ was the most sought after [1].

In the Republic of Serbia, the first programming skills during schooling can be acquired in the fifth grade of primary school in the subject of Informatics and Computing, where the curriculum of teaching and learning in each grade (5th to 8th), programming is dedicated to one teaching topic ). In the fifth grade, visual block programming is studied in the Scratch program, while in other grades, students work in the Python programming language.

At the secondary level, the scope of learning programming languages directly depends on the enrolled high school. In high schools, students

continue to acquire knowledge and programming skills in the Python programming language within the subject Computer Science and Informatics. There is a continuity in the continuation and expansion of knowledge from primary school, where Python is also studied. In secondary vocational schools, in the fields of electrical engineering, computer science and information technology, students have the opportunity to develop programming knowledge and skills in other programming languages, such as JavaScript, Java, PHP, C # and C ++. That is why it is necessary for them to decide for some of the specialized fields, such as computer electrician, information technology electrician, etc.

This paper deals with the issue of Object Oriented Programming in Primary School from the analytical aspect. His general aim is to try to answer questions about whether primary school students have a sufficiently comprehensive access to programming and programming languages, as well as whether there is space for higher levels in the curriculum for primary school in Informatics and Computing. the scope of studying object-oriented programming languages.

## II. OBJECT ORIENTED PROGRAMMING

Object-oriented programming is a programming paradigm, whose programming style is based on working with objects and classes. A class defines the structure (data) and behavior (commands) common to a set of objects. Each object of a certain class has a structure and behavior defined by the class, as if it were a replica of the class. Each class has its own data members and its own member functions, which are called class members. From classes, as a kind of template, instances (objects) can be produced, whose communication realizes the functionality of the whole system. Objects are called instances or instances of a class. In this way the

class represents a logical construction; the object represents physical reality. Each object has its own characteristics that are defined by the class. Based on the data defined by the class, it is possible to create a practically infinite number of objects [2].

A. *Basic principles of object-oriented programming*

All object-oriented programming languages use basic principles to implement an object-oriented programming model. The principles include [2]:

- **Abstraction** - Abstraction involves simplifying the characteristics of a class to emphasize important features while ignoring irrelevant ones. On that occasion, the details are ignored and only the common characteristics of the class are taken, depending on the needs of the program. The essence of abstraction consists in noticing the essential characteristics of the object being observed and distinguishing it from other objects on the basis of the observed properties. It focuses on the external appearance of the object, completely neglecting its interior, ie. implementation.
- **Encapsulation** - is one of the basic concepts of object orientation. It is a process where class information is protected from direct access. In that case, the only way to access it is through defined methods. This way, the details are hidden, so the user only knows what he can do with a certain object. It is also called closedness or encapsulation and is a concept completely complementary to abstraction. Encapsulation is achieved by dividing class members into public and private. Public members are free to use in any part of the program (outside the body of the class itself), while private members are available only within the class in which they are defined. Fields are usually private, while methods are mostly public.
- **Inheritance** - is the most important concept of object-oriented programming. According to him, a new one can be reported from one defined class. It inherits all members of the class and introduces its specific fields and methods. The derived class is a subclass (descendant), and the more general is the superclass (ancestor). In this way, a hierarchical hereditary line is created. Inheritance involves identifying common properties of different classes and greatly facilitates programming, because we lose

the need to write the same attributes several times.

- **Polymorphism** - is a property that the same method works differently, depending on the type or number of parameters that are passed to it. Polymorphism allows the base class to define functions that will be common to all derived classes, provided that those derived classes can implement those functions in their own way. This means that objects of a specific type can be considered as objects of the basic type. However, the polymorphic behavior of the call allows the derived object to express its diversity. Polymorphism helps reduce complexity, allowing the general class of actions to be approached in the same way. It is up to the translator to choose a specific action (ie method) according to the situation. The programmer does not have to choose manually. He just needs to remember and use the general approach.

B. *Object oriented programming languages*

Simula from 1967 is considered to be the first object-oriented programming language. It was created to simulate programs, where objects were the most important part of presenting information. Today, several programming languages are used that fully or partially use object-oriented programming principles [3].

- **Java** - is an object-oriented programming language based on classes, officially introduced in 1995. It is designed predominantly for object-oriented programming, using some procedural elements. This language allows developers to use once written code on multiple platforms that support Java. Due to its universality, it is one of the most popular programming languages in the world. This is especially true of working within web applications that deal with the client-server relationship. Interestingly, Java introduced the concept of classes into object-oriented programming, which was later adopted by other programming languages. Java has its modern application mostly in creating applications for mobile devices with the Android operating system.
- **JavaScript** - is a scripting language, which has certain object-oriented characteristics. This language is based on prototypes with first-order functions, which makes it a

language that supports object-oriented programming. However, JavaScript has certain differences, so there are no classes in this language, but prototypes are used. With newer versions of this language, the syntactic replacement "class" has been introduced, which does not represent the introduction of classes, but makes it easier for programmers who are used to them.

- C ++ - It is a general-purpose programming language that includes support for object-oriented programming. This programming language was created during the eighties of the last century as an upgrade of the original C language. And while it was originally called "C with classes", since 1983 it has received the current name C ++. Despite the criticism of some experts that this language is slow in some segments, it is one of the most popular programming languages.
- C # - was created as an improved version of the Java, C, and C ++ programming languages. The biggest advantage of programming in C # over the languages it came from is much easier to use. All it takes to write a single program in C # is a plain text editor like Notepad, as well as a .NET Framework program installed on your computer. This program is a large library of tools that can be used with the help of over 20 different programming languages. Because the .NET Framework is customized for many operating systems, writing code in C # allows you to create software for Windows, Linux, iOS, OSX, Android, and BSD environments. It is also important to note that C # is one of the case sensitive languages, which distinguishes between lowercase and uppercase letters. In addition, this programming language belongs to the group of so-called strongly typed languages, which require explicitly identified types in the code.
- Python - is a very powerful and flexible open-source programming language that can be used for Web and API development, Data Science, system automation, Machine Learning, robotics, artificial intelligence, game creation and much more. Python is also known as a "hacking programming language" because it is used by those who deal with Cyber security or testing systems and networks. Python programming can be

used in countless ways in everyday life. Anyone can use the Python programming language for free, either for commercial or other purposes. The ease with which it is learned and used, as well as its great practical application, have led to Python's continuous growth in the market both in the world and in our country. Its popularity is confirmed by the highest ranking in Stack Overflow and TIOBE Index surveys, a huge number of GitHub projects that use it, as well as the fact that for years this is the most wanted language that developers want to master in future [11] [12].

### III. PROGRAMMING IN PRIMARY SCHOOLS

According to the curriculum, there is no subject called programming in primary school. However, in the content of the subject Informatics and Computing, there is a teaching topic (area) Computing within which programming languages and programming are studied. Fifth grade students learn the Scratch programming language, and sixth, seventh and eighth grade students work in the Python programming language. The mentioned programming languages are presented more detailed in the following subsections.

#### A. Scratch programming language

Scratch is a high-level programming language. It is a visual programming language that contains elements of object-oriented programming. It allows easy creation of sequences, synchronization of their work and mutual communication. It is intended primarily for children and students, but also for others who want to use programming as a way of creative expression. It is applied in education in the field of multimedia and programming [4].

One of the main advantages of Scratch is reflected in the fact that it is a visual programming language, which is formed from blocks of commands, so it is almost impossible to make a syntax error when programming. The sets of block commands differ in color, and the blocks themselves within the same set of commands differ in their shape. A significant obstacle to learning programming at an early age has been removed by the fact that there is a small level of textual program syntax in Scratch, which is intuitively understandable to a school-age child, unlike classical programming languages. All this enables active learning of programming already in the fifth grade of primary school, and getting acquainted with it even earlier.

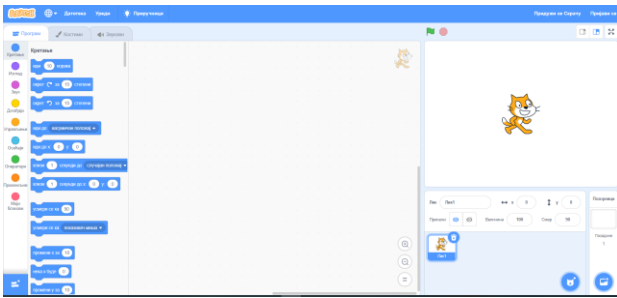

[5] Figure 1 - Online Scratch Editor layout

In Scratch, it can be programmed via an online or offline editor. The online editor is located at <https://scratch.mit.edu/>. It is desirable to create an account on it, so that the user has the ability to save projects. The offline editor can be downloaded at <https://scratch.mit.edu/download> and then installed on your computer. This version allows you to work without an internet connection, as well as save projects on a personal computer, without having user accounts.

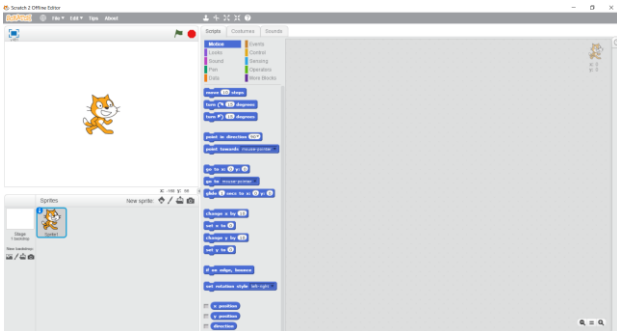

Figure 2 - Offline view of Scratch Editor 2.0

### B. Python programming language

The Python programming language has been around for more than three decades, and during that time it has slowly but surely gained more and more popularity. It originated in the Netherlands in the late 1980s and has been an open source language ever since. The syntax of this language is unique. Namely, unlike the vast majority of other programming languages, this language does not use curly braces to separate blocks of code, nor does it require the user to put a semicolon at the end of the command so that the language interpreter knows when the command is over. Python simply uses the indentation or tab button of your keyboard for this. Because of this, as well as many other features, such as how to write loops and conditions, this language very often serves as an introduction to programming for many young people around the planet. A huge number of countries that have programming in school curricula use Python for this purpose, so Serbia does not deviate from this rule either. Python has proven to be a very useful language for this use, as an introduction to programming [6].

Students use the Python interpreter environment and the Idle development environment. Both of these environments are available on your computer after installation, which can be downloaded from the link <https://www.python.org/downloads/>.

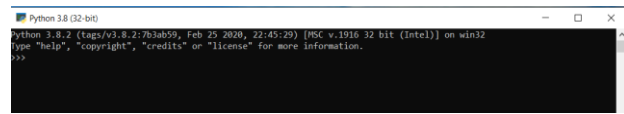

Figure 3 - Appearance of the Python interpreter window

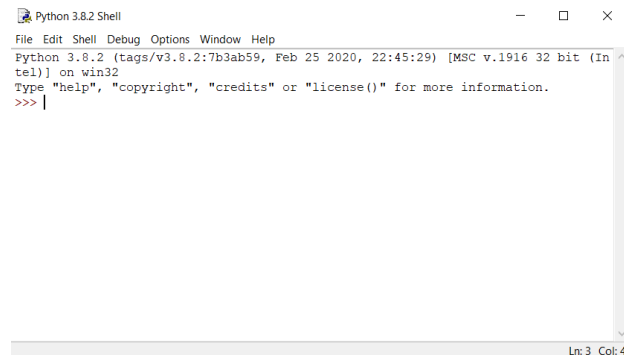

Figure 4 - Appearance of the Python IDLE development environment

A simple program is written in the Python interpreter, where feedback on the execution of the code line is immediately obtained. IDLE (Integrated Development and Learning Environment), is used to create, store and execute more complex program structures.

#### 1) PyGame library

A very interesting domain of programming application is the creation of programs that use the graphical capabilities of computers, ie. the ability to draw shapes, display images, create animations and simulations and ect. Such are, for example, computer games, which usually involve the user using a mouse or keyboard to control a character that is displayed on the screen and walks through the virtual world, overcoming obstacles and fighting against enemies. The Python programming language offers some graphics capabilities as part of its standard library (e.g. Turtle Graphics). However, a more advanced library is usually used for more advanced features and game programming. One such, suitable for learning computer graphics programming is the PyGame library.

PyGame allows you to draw different shapes (longer, rectangles, circles, ellipses, etc.). They can all be painted in different colors. In addition, it is possible to display images (.png, .jpg) on the screens, as well as print text in different fonts [7]. Pygame uses the Simple DirectMedia Layer (SDL) library,[a] with the intention of allowing real-time

computer game development without the low-level mechanics of the C programming language and its derivatives [13].

<sup>[7]</sup> Table 1 - Basic commands for working with the PyGame library

CODE LINE	MEANING
<code>py -m pip install pygame</code>	Installing the PyGame library
<code>import pzgame as pg</code>	The use of the PyGame library is enabled and given an abbreviated name <code>pg</code>
<code>pg.init()</code>	Initialize the PyGame library
<code>pg.quit()</code>	Turn off the PyGame library

#### IV. ANALYSIS OF THE CURRICULUM OF THE INFORMATICS AND COMPUTING

This chapter provides an analysis of the curriculum for the subject of Informatics and Computing in primary school. All grades 5 to 8 are included. The emphasis of the analysis is placed on the representation of programming in the total number of classes, as well as on the defined outcomes related to programming. Common to all grades, except the eighth, is that the total annual fund is 36 hours. The curriculum contains 3 areas:

- Information and communication technologies (ICT)
- Digital literacy
- Computing

In the following subchapters, the above-mentioned analysis is systematized by grades.

##### A. Fifth grade

As previously mentioned, in the fifth grade, the programming language Scratch is studied within the teaching area of Computing. The tables below show the distribution of classes by teaching areas, as well as the outcomes that students are expected to achieve within the area of Computing.

<sup>[8]</sup> Table 2 - Curriculum structure in 5th grade

AREA	NUMBER OF CLASSES	PERCENTAGE
ICT	11	30%
Digital literacy	7	20%
Computing	18	50%

<sup>[8]</sup> Table 3 - Expected outcomes

No	Outcome - the student will be able to:
1.	List the sequence of steps in solving a simple logical problem;
2.	Creates a simple computer program in a visual environment;

3.	Purposefully implements program structures and command blocks;
4.	Uses mathematical operators to calculate;
5.	Explain the project scenario and algorithm;
6.	Analyzes and discusses the program;
7.	Finds and fixes bugs in the program;

From tables 2 and 3, it is noticeable that the area of Computing includes 18 hours of teaching in the fifth grade, ie 50% of the total fund. Of those 18 hours, 6 are planned for practical work on projects in the field of programming, while the remaining 12 hours are planned for students to acquire basic programming skills and master a total of 7 outcomes. The outcomes are graded according to the Bloom's taxonomy scale, where students are initially expected to specify the sequence of steps in solving the problem (algorithm), then to create a simple computer program with a block programming system. After that comes the application of program structures, command blocks and mathematical operators. At higher levels, students are asked to explain, analyze and discuss important elements within the project task from visual block programming, while at the level of evaluation it finds and eliminates errors in the program.

##### B. Sixth grade

As previously mentioned, in the sixth grade, the Python programming language is studied within the Computer Science curriculum. The tables below show the distribution of classes by teaching areas, as well as the outcomes that students are expected to achieve in the field of programming.

<sup>[8]</sup> Table 4 - Curriculum structure in 6th grade

AREA	NUMBER OF CLASSES	PERCENTAGE
ICT	10	28%
Digital literacy	5	14%
Computing	21	58%

<sup>[8]</sup> Table 5 - Expected outcomes

No	Outcome - the student will be able to:
1.	Creates a simple program in a text programming language;
2.	Uses mathematical expressions for calculations in simple programs;
3.	Explain and apply the appropriate program structure (assignment commands, branches, loops);
4.	Uses numerical, textual and one-dimensional array values within the program;
5.	Explain the complex problem into simpler functional units (subroutines);
6.	Finds and fixes bugs in the program;

Table 4 shows that the topic of Computing in the sixth grade occupies 58% of the total annual fund of classes. Out of a total of 21 hours, 6 are planned for work on project activities, and the remaining 15 for achieving 6 outcomes from Table 5. Outcomes are similar in formulation to outcomes for the fifth grade, but the important difference is that this is the domain of text programming, for unlike the fifth grade where the programming is of the visual-block type.

### C. Seventh grade

The seventh grade is a kind of continuation of programming from the sixth grade, because the Python programming language is also processed. The difference is that the emphasis is on the functionality of the PyGame library.

[8] Table 6 - Curriculum structure in 7th grade

AREA	NUMBER OF CLASSES	PERCENTAGE
ICT	10	28%
Digital literacy	6	16,5%
Computing	20	55,5%

[8] Table 7 - Expected outcomes

No	Outcome - the student will be able to:
1.	It draws elements of 2D graphics with the help of a text library of a text programming language;
2.	Uses loops and a random number generator to draw more complex shapes;
3.	Plans, describes and implements a solution to a simple problem;
4.	Uses mathematical expressions for calculations in simple programs;
5.	Explain the complex problem into simpler functional units (subroutines);
6.	Explain and apply the appropriate program structure (assignment commands, branches, loops);
7.	Uses numerical, textual and one-dimensional array values within the program;
8.	Finds and fixes bugs in the program;

Compared to the sixth grade, in the seventh grade, according to the plan, one hour less is realized from the teaching area of Computing, ie 20 hours. From 8 pm, 6 were allocated for project activities, and the remaining 14 for the realization of 8 outcomes listed in Table 7. The expected outcomes correspond to the functions of the PyGame library.

### D. Eighth grade

The teaching area of computer science in the eighth grade took on a completely different dimension. In it, the Python programming language is used within the Jupiter interactive workbook. The

Jupyter interactive workbook allows you to enter text, perform calculations, process and display data, as well as run simpler Python programs. Each Jupiter workbook consists of a series of cells, and each cell can contain text, a mathematical expression, or a series of Python commands.

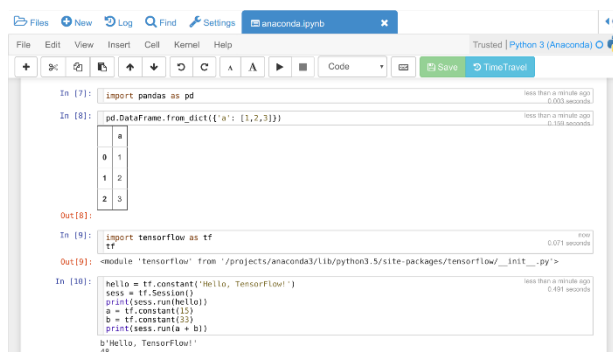

[9] Figure 4 - Appearance of the Jupiter workbook window

[8] Table 8 - Curriculum structure in 8th grade

AREA	NUMBER OF CLASSES	PERCENTAGE
ICT	8	23,5%
Digital literacy	5	15%
Computing	21	61,5%

[8] Table 9 - Expected outcomes

No	Outcome - the student will be able to:
1.	Using the appropriate programming language and accompanying tools, they solve the types of problems known from the materials of other subjects in which the formula is first expressed in general numbers and then replace specific values, where the task is formulated so that the program should solve it in the general case, in a case that assumes a larger number of input variables, ie differentiation of several possible scenarios and the like;
2.	Using appropriate tools and expressing the processing procedure in the program code, plan and implement the processing of a given set of data, as well as tabular and graphical presentation of the processed data;

Table 8 shows that the number of classes within the teaching topic Computing is almost the same as in the previous three grades. However, since the total annual fund of classes in the eighth grade is 34, and in the others 36, that makes the largest share as much as 61.5% per year. At first glance, only two outcomes are defined, but they are complex outcomes. Students are expected to have a multidisciplinary approach to problem solving, using the Python programming language, with an emphasis on processing and presenting data from the Jupiter workbook.



## V. CONCLUSION

Object-oriented programming languages undoubtedly represent the foundation when it comes to education in the field of programming. For people who plan to engage in programming work in life, it is necessary to continuously improve knowledge, skills and develop competencies in this area during all three cycles of education (primary, secondary and higher). Only in that way can one get a quality and educated programmer with adequately acquired fundamental knowledge, which was later methodically upgraded through lifelong learning and practice.

The analysis presented in the fourth chapter showed that students acquire basic programming skills in the fifth grade within the visually block way of programming. In the sixth grade, based on the achieved outcomes in terms of algorithmic problem solving, use of commands and mathematical operators, we move to the domain of text programming in the Python programming language. Knowledge and skills within Python are upgraded and expanded through seventh and eighth grade.

Also, from the analysis, it can be seen that the representation of classes in which programming is taught within the subject Informatics and Computing is very large, ie from 50% in the fifth to as much as 61.5% in the eighth grade. The outcomes are clearly and precisely set, so that students achieve an enviable level of competencies in the field of object-oriented programming. Introducing the study of another programming language in primary school, e.g. C ++, C # or Java, would undoubtedly contribute to diversity and a greater chance for students to choose specialized IT directions in their choice of further education. However, with programming integrated into another subject (Informatics and Computing), which has a fund of only one hour per week, or 36 hours per year, this is simply not possible. An optimal solution would be to increase the fund to two hours a week, ie 72 hours a year, at least in the seventh and eighth grade, which would create space for such a thing.

The Ministry of Education, Science and Technological Development of the Republic of

Serbia (MPNTR) has launched an initiative to develop a Strategy for the Development of Education in the Republic of Serbia until 2030 (SROVRS 2030), ie a new public policy document for the next ten years. The main reasons for launching the initiative for drafting SROVRS 2030 are that the current strategy expires at the end of 2020, and it is necessary to draft a new strategic document as a comprehensive public policy document in the field of education development in the Republic of Serbia (RS) that respects and evaluates achieved results. , changes in context from 2012 to the present [10]. It is within this strategy that it is possible to recognize the importance of acquiring broad knowledge and skills in the field of object - oriented programming for primary school students and increase the annual fund of classes in Informatics and Computing, as a strategic interest in education in this decade.

## REFERENCES

- [1] <https://www.helloworld.rs/blog/>, accessed March 2021.
- [2] Nenad Jovanović, Object Oriented Programming, Business School 2012, ISBN 978-86-7544-089-5.
- [3] <https://www.it-akademija.com/objektno-orijentisano-programiranje>, accessed March 2021.
- [4] Olga Ristić, Danijela Milošević and Vlade Urošević, The importance of programming languages in education, TECHNICS AND INFORMATICS IN EDUCATION 6th International Conference, Faculty of Technical Sciences, Čačak, Serbia, 28–29th May 2016.
- [5] <https://scratch.mit.edu/projects/editor/>, accessed March 2021..
- [6] K. R. Srinath, Python – The Fastest Growing Programming Language, International Research Journal of Engineering and Technology (IRJET), Volume: 04 Issue: 12 | Dec-2017.
- [7] <https://www.eucionica.rs/>, accessed March 2021.
- [8] <http://logosedu.rs/stranica/55345/nastavni-planovi-i-pripreme-za-osnovnu-skolu-predmetna-nastava>, accessed March 2021.
- [9] <https://cocalc.com/doc/jupyter-notebook.html>, accessed March 2021.
- [10] Proposed strategy for the development of education and upbringing in the Republic of Serbia until 2030, MPNTR R: Srbije, 2021.
- [11] <https://insights.stackoverflow.com/survey/2020#technology-most-loved-dreaded-and-wanted-languages>, accessed April 2021.
- [12] <https://www.tiobe.com/tiobe-index/>, accessed April 2021.
- [13] Rakshit Tyagi, Prof. Shreya Kapoor, Comparing 2D game in Lua with game engine of love and in python with pygame, International Journal for Modern Trends in Science and Technology, 6(12): 370-372, 2020

# Data Processing Using Analytical Hierarchical Process in Real Circumstances

D. Krstev\*, A. Krstev\*\*, S. Dimitrov\*,

\*Faculty of Mechanical Engineering, University of Stip, Republic of N. Macedonia,

\*\*Faculty of Computer Science, University of Stip, Republic of N. Macedonia,  
dejan.krstev@ugd.edu.mk, aleksandar.krstev@ugd.edu.mk, sasko.dimitrov@ugd.edu.mk

**Abstract.** In the development of the industry of small and medium enterprises that are involved in one of the most specific activities such as working with products, materials it gives and seeks opportunities for optimizing the basic management activities in the work of a company. Today, many data are constantly generated that require proper processing and access to them, especially when it comes to supply chain management and business logistics. Standard processing techniques may not meet these requirements. The development of information technology and decision theory has contributed to the emergence of the application of modern-applicable methods and approaches to data processing and analysis. The way of processing data from traditional data processing tools are adapted for data processing and with the help of tools and mathematical methods that enable processing and analysis of big data that depend on several criteria such as time, resources, quality, and distance when it is about delivering work material. The identification and analysis of the problem to be solved, the determination of the possible solutions to the problem, the criteria according to which the possible solutions are evaluated, i.e., the alternatives and the choice of the best possible solution is a decision-making process. It is the choice of the best, from the most possible alternative solutions to the problem such as the problem of delivery of specific material such as leather considering the quality and price.

**Keywords:** data processing, supply chains, data, decision making, analysis, mathematical methods.

## I. INTRODUCTION

Logistics in the modern world is becoming a current issue to which more attention is paid. In many countries with developed market economies, the share of logistics activities in the formation of gross national product exceeds 20%, which directly affects all aspects of the economy (inflation, productivity, interest rates, etc.). This is one of the main reasons for the increased interest in this issue. In the field of logistics, you can find several terms such as: materials management, physical distribution, business logistics, logistics management (synonymous with business logistics), supply chain management and others. All these terms explain the same area - logistics. This fact is positive, because it provides great flexibility to companies in terms of changing the product range,

production of small batches and short delivery time of the final product. This is a key factor for successful cooperation with foreign partners and for the survival of this branch which is under constant pressure from competition and market laws. [1,2,4]

## II. RESEARCH METHODOLOGY

Multi-criterion optimization is an area where a mathematical model is formed for a particular mathematical problem, considering multiple goals at the same time. It is essential that the most favourable alternative solution be found according to all the criteria considered, which can be expressed in different units of measure, different currencies, different probabilities of occurrence or subjective estimates. The task of multi-criteria decision optimization is in cases where important decisions are considered and made, such as capital investment decisions, which are characterized by a relatively large number of criteria. For effective analysis of decisions and finding an appropriate solution, the criteria are selected and grouped into economic, technical, technological, social, and environmental criteria. Models that form a mathematical model for a real problem from the beginning consider multiple criteria simultaneously and develop in the field of multi-criteria optimization. Many criteria in the models of multi-criterion optimization mean not only the realization of modelling, but also increasing the reliability of the obtained results. The disadvantages of multi-criteria optimization are the consideration of several criteria and the way they define weights in the model, which in turn makes this process of mathematical modelling complex. The development of multi-criteria optimization methods started with problem solving step by step, i.e., methods for specific problems were developed. Defining the effects of weights in the model of this process with mathematical modelling makes it complex in today's conditions of development of mathematics as a science. There are a few optimization methods and other quantitative mathematical methods that can be applied to

problem solving and decision making in the planning and design processes in industry. [3]

### III. METHODS OF DECISION MAKING AND THEIR APPLICATION

Mathematical-model optimization methods have been developed for solving problems in planning and design in the different fields, which consists of preparatory work for defining and developing the mathematical model. From this set of modelling methods, from the position of application, the following groups can be distinguished:

- Models of one-criteria optimization are: linear programming, nonlinear programming, dynamic programming, etc.
- Models of multi-criterion optimization are: AHP method, ELECTRA method, PROMETHEE method, VIKOR method and others. These methods belong to the group of multi-attribute decision making methods. Working with them is different depending on how the models are calculated and the input data (alternatives and criteria).
- AHP Method - The Analytical Hierarchical Process (AHP) method was developed by Thomass Saaty (1980), who is the founder of the method as a professor at the Wharton Business School in Philadelphia and is a tool in decision analysis. The method of analytical hierarchical processes is one of the classic methods of multi-criteria optimization, which solves complex decision-making problems. Based on defined decision criteria, it helps researchers in choosing the most favourable alternative. This method is suitable for use in cases when there is not enough information from the observed alternatives in the decision-making process. [1]

### IV. MATERIAL AND METHOD OF OPERATION

Analytical hierarchical process (AHP) is based on the concept of balance used to determine the overall relative importance of a set of attributes, activities or criteria and refers to the analysed problem with the decision. This can be achieved by structuring any complex decision-making problem, involving multiple individuals, multiple criteria, and multiple periods at several hierarchical levels, assigning weights in the form of a series of double-piece matrices, and then using Expert decision support system to determine normalized weight.

These weights are used to estimate the attributes at the lowest level of the entire hierarchy. The thus understood process of modelling includes four stages: Problem structuring, Data collection, Relative weight assessment and determining the solution to the problem. The problem structuring stage consists of breaking down a complex problem of decision-making into a series of hierarchies where each level represents a smaller number of managed attributes. Then, they break down into another set of elements that correspond to the next level and in the same order as *Figure 1*. This hierarchical structuring of any problem-solving problem in this way is an effective way to deal with the complexity of real problems and identify significant one's attributes to achieve the overall goal of the problem. The method (AHP) allows the realization of independence - independence between attributes to disintegrate at different hierarchical levels. [1]

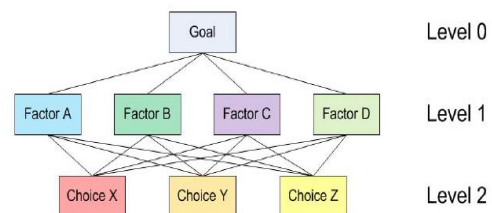

Figure 1. Structuring the problem

The second stage of the method (AHP) begins with data collection and measurement. It is then necessary to assign a relative estimate of pairs of attributes to one hierarchical level, then to the next level, and so on, to the last level. A nine-point scale for weight distribution in *Table 1*, has proven to be extremely reliable in solving real-world problems.

Table 1. Nine-point scale according to saaty

AHP Scale of Importance for comparison pair ( $a_{ij}$ )	Numeric Rating	Reciprocal (decimal)
Extreme Importance	9	1/9 (0.111)
Very strong to extremely	8	1/8 (0.125)
Very strong Importance	7	1/7 (0.143)
Strongly to very strong	6	1/6 (0.167)
Strong Importance	5	1/5 (0.200)
Moderately to Strong	4	1/4 (0.250)
Moderate Importance	3	1/3 (0.333)
Equally to Moderately	2	1/2 (0.500)
Equal Importance	1	1 (1.000)

The third stage of the method (AHP) involves the assessment of relative weights. Pair comparison matrices will turn into problems with important values to obtain normalized and unique weight agitators for all attributes at each level of the hierarchy. The assumption is that there are n levels

of the hierarchy of attributes  $A_1, A_2, \dots, A_n$  with vector weight  $t = (t_1, t_2, \dots, t_n)$ . It is necessary to find  $t$  to determine the relative importance of  $A_1, A_2, \dots, A_n$ . Approaching the comparison of pairs  $A_i$  and  $A_j$  of all attributes, as the degree to which  $A_i$  dominates over  $A_j$ , i.e. we are, i.e., to be able to form a matrix for comparing pairs.

$$A = (a_{ij}) = \begin{pmatrix} t_1/t_1 & t_1/t_2 & \dots & t_1/t_n \\ \vdots & \vdots & \vdots & \vdots \\ t_n/t_1 & t_n/t_2 & \dots & t_n/t_n \end{pmatrix}$$

The last stage of the method (AHP) involves finding a composite normalized vector. Because successive hierarchical levels are interconnected, the single composite vector of unique and normalized weight vectors for the entire hierarchy will be determined by multiplying the weight vectors by all subsequent levels. This composite vector will then be used to find the relative priorities of all subjects at the lowest hierarchical level, which allows to achieve the set goals of the overall problem.

#### V. RESEARCH STUDY USING THE METHOD OF ANALYTICAL HIERARCHICAL PROCESS (AHP)

The main purpose of this paper is to propose a modern scientific methodology such as (AHP) that will be used in selecting the most favourable producers and suppliers of different materials for a company, using the methods for multicriteria decision making as a modern approach uses analyse the problem. to identify alternatives (variant solutions). selection of criteria and definition of their weights. to transform the qualities of the attributes (criteria). making a multi-criteria model. solving the model and determining the optimal solution.

To solve the problem, it is necessary to analyse the technical-economic parameters by making a model for selection of an appropriate manufacturer and supplier of material, according to a multi-criteria decision-making method. In our case, four alternative hypothetical models of material manufacturers and suppliers are given, which should be used for an industrial process in which chemical preparations with their basic characteristics are used:

Table 2. Nine-point scale according to saaty

No.	Alternative	Mark
1	Istanbul - manufacturer and supplier	A1
2	Thessaloniki - manufacturer and supplier	A2
3	Belgrade - manufacturer and supplier	A3
4	Durres - manufacturer and supplier	A4

Defining criteria for multi-criteria decision making: **Criteria 1** - Price of material by appropriate quantity, **Criteria 2** - Material performance ("positive" properties),

**Criteria 3** - Delivery time, (*hours*),

**Criteria 4** - Location (distance from production site to industrial plant) (*km*),

**Criteria 5** - "Material quality" according to the method (appearance/tones).

#### VI. SOLVING A MULTI-CRITERIA MODEL IN SELECTING THE BEST MANUFACTURER AND BIDDER ACCORDING TO THE REQUIREMENTS OF A COMPANY

The calculation methodology uses the AHP method for multi-criteria decision making described in the previous chapters. The data used for this illustration of problem solving are hypothetical. At the beginning, a decision matrix is formed with quantitative and qualitative assessments of the criteria that were considered as input data of the model, during processing the following matrix is obtained.

Table 3. Real data from the bidders

Alternatives	Criteria				
	K1	K2	K3	K4	K5
Goal	min	max	min	min	max
A1	3100	1,5	9,10	814	Very High
A2	6250	1,4	2,53	237	High
A3	5910	1,2	4,40	432	Average
A4	4560	1,1	3,45	242	Average

The transformation of qualitative attributes, i.e. in numerical values and they are ranked for each alternative in numerical scale that are presented in the matrix form of the AHP algorithm method that provides means for decomposing parts of the problem in a hierarchy of subproblems that can be more easily understood and subjectively evaluated.:

Table 4. Nine-point scale according to saaty with numerical values

Qualitative assessment	Very low	Low	Average	High	Very High	Type of criteria
Quantitative assessment	1	3	5	7	9	max
	9	7	5	3	1	min

Table 5. Nine-point scale according to saaty with numerical values presented in the real data from the bidders

Alternatives	Criteria				
	K1	K2	K3	K4	K5
Goal	min	max	min	min	max
A1	3100	1,5	9,10	814	9
A2	6250	1,4	2,53	237	7
A3	5910	1,2	4,40	432	5
A4	4560	1,1	3,45	242	5

The development of a multi-criteria model with the AHP method is structured in four stages and is processed as follows: Stage 1. Structuring the

problem, Stage 2. Data collection, Stage 3. Assessment of relative weights, Stage 4. Determining the solution to the problem.

**Table 6. Data before interaction and criteria weight**

Criteria	Criteria weight	A1	KxA1	A2	KxA2	A3	KxA3	A4	KxA4
K1	0,336	0,490		0,338		0,097		0,074	
K2	0,378	0,418		0,383		0,116		0,083	
K3	0,145	0,442		0,392		0,096		0,070	
K4	0,056	0,370		0,455		0,097		0,078	
K5	0,084	0,381		0,459		0,094		0,065	

**Table 7. Data interaction and criteria weight**

Criteria	Criteria weight	A1	KxA1	A2	KxA2	A3	KxA3	A4	KxA4
K1	0,336	0,490	0,165	0,338	0,114	0,097	0,033	0,074	0,025
K2	0,378	0,418	0,158	0,383	0,144	0,116	0,044	0,083	0,031
K3	0,145	0,442	0,064	0,392	0,057	0,096	0,014	0,070	0,010
K4	0,056	0,370	0,021	0,455	0,026	0,097	0,005	0,078	0,004
K5	0,084	0,381	0,032	0,459	0,039	0,094	0,008	0,065	0,006
Total			0,440		0,380		0,104		0,077

**Table 8. Final ranking of the alternatives**

	Total	Rank
A1	0,440	1
A2	0,380	2
A3	0,104	3
A4	0,077	4

## VII. CONCLUSION

This paper presents a process of optimal selection of procurement of materials for the needs of a small and medium enterprise dealing. The AHP method as a method for multi-criteria evaluation and selection has been used for the research conducted in this paper. The method is first explained theoretically, all the procedures by which it is used in everyday decision-making in the logistics process. The main problem with the application of this method is the definition of decision-making attributes in the second level of the hierarchical structure for the selection of criteria and the assessment of their relative weights. The definition of alternatives is based on the budget and the basic requirements of the end user that would meet the basic criteria for production considered when choosing a suitable supplier of suitable material.

After the assessment it is shown that the best supplier is the Istanbul supplier even, although it is the furthest place based on its location, but it is more financial and quality suitable for the enterprise. Final ranking of the alternatives are showing the advantage of Istanbul as most adequate alternative for enterprise dealing.

## REFERENCES

- [ 1.] Saaty, T., *Fundamentals of Decision Making and Priority Theory with Analytic Hierarchy Process*, RWS Publications, Pittsburgh, 1994.
- [ 2.] Blanchard, Benjamin S., & John E. Blyler (2016). *System engineering management*. John Wiley & Sons.
- [ 3.] Bassham, G., Irwin, W., Nardone, H., & Wallace, J. M. (2002). *Critical thinking*. Boston: McGraw Hill.
- [ 4.] Raihan, Ahmed & Islam, Farzana & Ali, Syed Mithun. (2019). *Modelling of Supply Chain Risks in the Leather Industry*

# Comparison of C ++ and Python programming languages in teaching

S.Mrđen\*, E. Brtko\*, V. Makitan\*

\* University of Novi Sad/Technical Faculty “Mihajlo Pupin”, Zrenjanin, Republic of Serbia  
mrdjen.simo@gmail.com, eleonorabrtka@gmail.com, vesna@tfzr.uns.ac.rs

**Abstract** - In paper, we consider the differences between Python and C ++ programming languages, specifically in relation to their characteristics that make a difference when learning one or another programming language. We did not process the many remaining differences, although, of course, they do exist. The focus was on the differences that would show which language is more beginner-friendly in teaching.

## I. INTRODUCTION

You may still wonder why Python? Or why teach programming with Python? The debate of Python vs C++ is an intriguing topic since both programming languages are very different in terms of their syntax, simplicity, use, and overall approach to programming. Therefore, people find it difficult when choosing which programming language to learn. C++ is a general-purpose programming language with its roots in the C language. Even though Python is also a general-purpose, it is a high-level language, meaning that Python code is easy-to-read and understand. Python is much more beginner-friendly, while C++ is a more complicated, low-level language. C++ has more syntax rules and other programming conventions, while Python aims to imitate the regular English language. When it comes to their use cases, Python is the leading language for machine learning and data analysis, and C++ is the best option for game development and large systems. However, authors think the most direct answer is that programming in Python is simply a lot of fun and more productive.

When teacher teaches computer science courses, he wants to cover important concepts in addition to making the material interesting and engaging to students. Unfortunately, there is a tendency for introductory programming courses to focus far too much attention on mathematical abstraction and for students to become frustrated with annoying problems related to low-level details of syntax, compilation, and the enforcement of seemingly arcane rules.

Although such abstraction and formalism is important to professional software engineers and

students who plan to continue their study of computer science, taking such an approach in an introductory course mostly succeeds in making computer science boring. When he teaches a course, he doesn't want to have a room of uninspired students. He would much rather see them trying to solve interesting problems by exploring different ideas, taking unconventional approaches, breaking the rules, and learning from their mistakes. In doing so, he doesn't want to waste half of the semester trying to sort out obscure syntax problems, unintelligible compiler error messages, or the several hundred ways that a program might generate a general protection fault [1].

The opinion of the authors and it seems that a large part of the community dealing with this issue is that Python is a very good choice as a language to start learning an object-oriented paradigm.

It is often said that the measure of the simplicity of a programming language is the way in which the program "Hello World!" is written. Obviously, the Python syntax (Fig. 1) is much simpler than the Java syntax (Fig. 2) or syntax in C++ (Fig. 3).

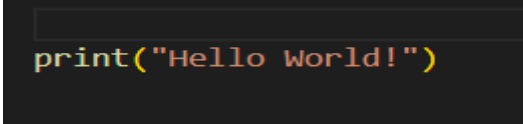

```
print("Hello World!")
```

Figure 1. Program "Hello World!" in Python

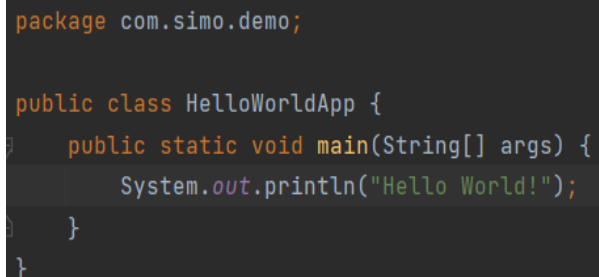

```
package com.simo.demo;  
  
public class HelloWorldApp {  
    public static void main(String[] args) {  
        System.out.println("Hello World!");  
    }  
}
```

Figure 2. Program "Hello World!" in Java

```
// Your first C++ Program
#include <iostream>

int main() {
    std::cout << "Hello World!";
    return 0;
}
```

Figure 3. Program "Hello World!" in C++

## II. ABOUT PYTHON AND DIFFERENCES IN RELATION TO C++

Python as well as C ++ are examples of high-level languages; other high level languages are PHP, C #, and Java ... Python is an interpreted language which means it does not need to be compiled into machine language instructions before execution and the programmer can use it directly to run the program.

This makes it comprehensive enough that language can interpret an emulator or virtual machine on top of the machine's natural language, which is what hardware understands. Python is a high-level programming language and can be used for complex scenarios. High-level languages deal with variables, arrays, objects, complex arithmetic or logical expressions and other abstract concepts of informatics in order to make it more comprehensive and thus exponentially increase its usability. Python is also a general-purpose programming language, meaning it can be used in all domains and technologies. Python also features a dynamic-type system and automatic memory management that supports a wide range of programming paradigms, including object-oriented, imperative, functional, and procedural [2].

### A. Simple syntax and less coding

Python has a simple syntax, also requires the least amount of code among other languages, and in fact the amount of coding is only 1/5 compared to other OOP languages. Python has built-in libraries (modules) such as Numpy for scientific calculations, Scipy for advanced computing and Pybrain for machine learning (Python Machine Learning), making it one of the most popular programming languages for artificial intelligence .

Python developers around the world provide comprehensive support and help through forums and tutorials which greatly simplifies the job, and makes coding easier than in any other popular language. Python is an independent platform and is therefore one of the most flexible and popular choices for use on a variety of platforms and technologies, and with the least setup in basic coding.

There are no primitive types in Python, all types are objects.

### B. Dynamic Typing

Unlike C ++, Python uses dynamic typing, which means you can assign variables to different types of data (Fig. 4). This makes Python very flexible in assigning data types; differs from other languages where variables must be explicitly declared when they are of the data type [3].

```
In [1]: my_dogs = 2
In [2]: my_dogs
Out[2]: 2
In [3]: my_dogs = ['Sammy', 'Frankie']
In [4]: my_dogs
Out[4]: ['Sammy', 'Frankie']
```

Figure 4. Example of dynamic typing in Python

### C. String type differences between C ++ and Python

Strings in Python are actually sequences, which basically means that Python follows each element in a string as a sequence. For example, Python understands that the string "Hello" is a string of letters in a certain order. This means that we will be able to use indexing to capture certain letters (such as the first or last letter)[4].

In Python, square brackets [] are used to call an object with an index element. (Fig. 5). Indexing starts from 0.

```
# Assign s as a string
s = 'Hello World'

#Check
s
'Hello World'

# Print the object
print(s)
Hello World

Let's start indexing!

# Show first element (in this case a letter)
s[0]
'H'

s[1]
'e'

s[2]
'l'
```

Figure 5. Example of indexing String

It is important to note that strings have an important property known as immutability, as well as the C ++ and Java programming languages. This

means that once a string is created, the elements within it cannot be changed. But strings can be joined! (Fig. 6).

```
s
'Hello World'

# Concatenate strings!
s + ' concatenate me!'

'Hello World concatenate me!'

# We can reassign s completely though!
s = s + ' concatenate me!'

print(s)

Hello World concatenate me!

s
'Hello World concatenate me!'
```

Figure 6. Example of joining Strings

#### D. Lists in Python

Lists can refer to the most general version of the sequence in Python. Unlike strings, they are mutable, which means that elements within a list can change. Lists are defined by square brackets [] and commas that separate each element [5] in the list (Fig. 7).

```
# Assign a list to an variable named my_list
my_list = [1,2,3]
```

Figure 7. Example of list of integers

This is an example of a list of integers, but lists can contain different types of objects (Fig. 8).

```
my_list = ['A string',23,100.232,'o']
```

Figure 8. Example of list of different types of objects

#### E. Dictionaries in Python

Dictionaries are a collection of objects that are stored with a key, while in the C ++ programming language this collection is called a map. Unlike a list or string that places objects in their relative position. This is an important difference, dictionaries will not keep order because they have key-defined objects. Python's dictionary consists of key and value pairs (Fig. 9). This value can be almost any Python object.

```
# Make a dictionary with {} and : to signify a key and a value
my_dict = {'key1':'value1','key2':'value2'}

# Call values by their key
my_dict['key2']

'value2'
```

Figure 9. Example of creating dictionary in Python

It is important to note that dictionaries, unlike C ++, are very flexible in the types of data they can contain (Fig. 10).

```
my_dict = {'key1':123,'key2':[12,23,33],'key3':['item0','item1','item2']}

# Let's call items from the dictionary
my_dict['key3']

['item0', 'item1', 'item2']

# Can call an index on that value
my_dict['key3'][0]

'item0'

# Can then even call methods on that value
my_dict['key3'][0].upper()

'ITEM0'
```

Figure 10. Example of dictionary with data of different types

Python is very powerful with the flexibility of nesting objects and calling methods on them.(Fig. 11).

```
# Dictionary nested inside a dictionary nested inside a dictionary
d = {'key1':{'nestkey':{'subnestkey':'value'}}}
```

Figure 11. Example of nesting dictionaries in Python

#### F. Tuples in Python

In Python, tuples are very similar to lists, however, unlike lists, they are immutable, which means they cannot be changed [6]. This is another important difference in relation to the C ++ programming language, where there is no similar collection. The most similar would be the enum type.

Tuples are used to represent things that do not need to be changed, such as days of the week, or dates on a calendar.

The tuples construction uses a simple parenthesis () with comma-separated elements (Fig. 12).

```
# Create a tuple
t = (1,2,3)

# Check len just like a list
len(t)

3

# Can also mix object types
t = ('one',2)

# Show
t

('one', 2)

# Use indexing just like we did in lists
t[0]

'one'

# Slicing just like a list
t[-1]

2
```

Figure 12. Example of tuple in Python



*G. Differences in expressions between C++ and Python*

Let's make a simple expression that says, "If a is greater than b, give the variable a a value of 2 and the variable b 4."

Version C++:

```
if (a>b){  
    a = 2;  
    b = 4;  
}
```

Version Python:

```
if a>b:  
    a = 2  
    b = 4
```

Obviously, Python is less cramped and much more readable than the first version. How does Python manage this? We go through the main differences: Python is solved by `()` and `{ }` by including two main factors: a colon and whitespace. The expression ends with a colon, and whitespace is used (indentation) to describe what happens when the expression is executed.[7].

Another big difference is the lack of semicolons in Python. A semicolon is used to indicate the endings of an expression in many other languages, but in Python the end of a line is the same as the end of an expression.

### III. CONCLUSION

Obviously, Python as a programming language is the most suitable for learning for someone who is new to the concept of OOP. Its conciseness, simple syntax, clarity of the code itself, in the opinion of the

authors, makes it a perfect candidate for anyone who wants to enter the world of OOP. Unlike other most popular object-oriented programming languages, such as C++, Java, and C#, many concepts are simplified. For example, in Python encapsulation of objects is avoided, access modifiers are not declared, there is only a convention on marking objects that should not be accessed from other classes, but it is not mandatory. This approach makes it much easier for students to master Python. Also, avoiding declaring a variable type, as well as a type that returns a function, or a method, is less confusing to a beginner. Another important feature, the use of indentation instead of parentheses, makes it easier to understand the scope principle.

### ACKNOWLEDGMENT

This research is financially supported by Ministry of Education and Science of the Republic of Serbia under the project number TR32044 "The development of software tools for business process analysis and improvement", 2011-2021.

### REFERENCES

- [1] Allen B. Downey, Jeffrey Elkner, Peter Wentworth, and Chris Meyers, "How to Think Like a Computer Scientist: Learning with Python 3", Green Tea Press (January 4, 2002); ReadTheDocs.org (eBook, Feb 26, 2019)
- [2] Bill Lubanovic, "Uvod u Python - Moderno računarstvo u jednostavnim paketima", O'Reiley 2015, CET 2015
- [3] <https://www.udemy.com/course/complete-python-bootcamp>
- [4] [https://www.tutorialspoint.com/artificial\\_intelligence\\_with\\_python/artificial\\_intelligence\\_with\\_python\\_getting\\_started.htm](https://www.tutorialspoint.com/artificial_intelligence_with_python/artificial_intelligence_with_python_getting_started.htm)
- [5] <https://www.geeksforgeeks.org/object-oriented-programming-in-cpp/>
- [6] <https://www.udemy.com/course/complete-python-bootcamp>
- [7] <https://www.udemy.com/course/python-and-django-full-stack-web-developer-bootcamp/>

# The Virtual Physics Laboratory

I. Borjanovic\*

\* Technical College of Applied Sciences in Zrenjanin, Zrenjanin, Serbia  
iris@ipb.ac.rs

**Abstract** - Results of the project „The Virtual Physics Laboratory“ are presented in this paper which aim was to modernize physics course at Technical College of Applied Sciences in Zrenjanin. As it is not possible to perform all types of physics experiments at school laboratories, one of the novelties this project brought was the usage of interactive physics simulations, as a good way to provide better understanding of physics phenomena. Contemporary engineers should also be able to work with software for statistical data analysis and other programs which provide easier and faster problem solving. We incorporated a few new software packages and trainings for students on how to work with this software as part of our lesson and project tasks. This way students acquired all the necessary competences required for the profession of a contemporary engineer.

## I. INTRODUCTION

The project „Virtual Physics Laboratory“ [1], was cofinanced by the Provincial Secretary for Higher Education and Scientific Research and was created at the Technical College of Applied Sciences in Zrenjanin in 2021 and is still in the process of realization. The main idea of the project was to bring some improvements into education, with the primary focus on the Sector of Physics at our college. During the courses at Technical College of Applied Sciences in Zrenjanin, beside standard lessons and exercises, a few additional activities were performed:

- the use of interactive physics simulations,
- the use of different program packages like Excel for presenting and fitting experimental results, XLSTAT for statistical data analysis, GeoGebra for mathematical modeling in dynamical surrounding and WolframAlpha for all types of online computations and information in many different aspects of science.

More information about the project as well as instructions about the use of simulations and the above mentioned software packages are available at the college website [1], [2] and also in the project's Google Classroom [3] (classroom code: wgfx7r, classroom name: Virtuelna laboratorija fizike).

## II. INTERACTIVE SIMULATIONS

PHET interactive simulations are available online on the website of the University of Colorado Boulder [4]. These simulations can also be downloaded and used locally offline. There are 44 physics simulations in total, moreover, some additional simulations for mathematics, biology, chemistry and other sciences could be found there. These simulations are suitable for students of all ages from primary school to university. By opening account and signing in on the Colorado Boulder University website [4], instructions for teachers on how to use simulations could also become available. Translations of simulations into different languages exist there, too.

We also wrote instructions [5] for our students on how to use and work with simulations. During physics lessons and exercises students worked with 31 simulations which covers different physics topics like mechanics, elasticity, waves, fluids, thermodynamics, electrodynamics, optics, modern physics. Students find these simulations very interesting and instructive as they provide them the better understanding of Physics.

## III. EXCEL

As a part of physics laboratory exercises students learned to present experimental data on a graph and to fit these data with linear, exponential, logarithmic or polynomial functions in Excel, depending on the type of data. Instructions written for them are available at [6], [7]. Students used to compare the results obtained in Excel with results obtained by hand by plotting and fitting experimental data on paper which they found to be slower and less precise.

In order to introduce students into the field of statistics and probability in physics, first lectures on distributions were given to them. Then followed their usage of Data Analysis (DescriptiveStatistics) package in Excel with which students learned to obtain parameters of the Gaussian distribution (mean

value and standard deviation) from experimental data. Instructions and explanations for students could be found at [8]

Students think these analyses in Excel are very applicable to other areas of engineering, too.

#### IV. XLSTAT

XLSTAT [9] is a software add-on for Excel which provides professional statistical data analysis in many scientific areas (physics, mathematics, engineering, medicine, psychology, economy). It is a flexible program that allows users to study, adapt and share results in Excel. It has more than 240 statistical features at dispose. It is often used at universities and in businesses as it has many users all over the world. XLSTAT covers four sectors of statistical data analysis and they are:

- describing data,
- exploring and clustering data,
- statistical testing,
- statistical modeling.

Very useful webinars on how to use XLSTAT are available [10], too. XLSTAT contains a large base of algorithms for different types of data analysis.

Our students followed the online course on the use of XLSTAT, focusing on different statistical tests. We also provided them the opportunity to work with this program in our physics laboratory. This version of XLSTAT program can be found in the laboratory (Basic +) and contains also the possibility of supervised machine learning and prediction which is to be used for some future analysis in Data Science.

#### V. WOLFRAMALPHA

WolframAlpha [11] is used to be defined as a computational intelligence. It is a software which provides computations in many different areas like mathematics, physics, astronomy, chemistry, engineering, biology, medicine, economy and many others. It also contains huge database of information in natural and social sciences, sport, culture. By opening account on WolframAlpha website all these facilities can be used for free just by logging in, nothing else is needed to be installed. If we want more detailed step by step solutions, in mathematics for example, then commercial professional versions are also available.

We provide training for our students how to use WolframAlpha. Instructions for them were written,

too [12]. Beside the free versions, students can also use professional versions of the program in our physics laboratory. They found this program very useful, especially for mathematical and physical computations.

#### VI. GEOGEBRA

GeoGebra [13] is a free software for class activities, graphing, geometry, collaborative whiteboard. It contains graphing calculator for functions, geometry, algebra, calculus, statistics and 3-dimensional mathematics. It has large application in technical sciences and enables users to perform mathematical modeling in dynamical environment. It can be installed locally or used on cloud. Geogebra is beneficiary for using for both professors and students.

Professors use it because it enables users to plan and present lessons better. Geogebra allows professor to be innovative and to make lessons that students will find intriguing and amusing. There is also a database of already made materials which other professors create that can be shared and used, too. Among them are for example the problem of motion (physics), problem of mixtures (chemistry), Pythagoras theorem (mathematics) and many others.

Students generally find mathematics more real with GeoGebra as it makes a link between geometry and algebra in a new visual way. In this manner students can see and experience mathematics in the end. Students who use GeoGebra are found to be very motivated.

Slides from our students' course are available at [2],[3].

#### VII. CONCLUSION

As science and information technology moves forward, education also needs updates. Students, future engineers, should know how to work with modern software tools in order to be able to face problems and challenges as they arise in their future profession.

As part of the project's ("The Virtual Physics Laboratory") activities, students at Technical College of Applied Sciences in Zrenjanin, learned to work with modern software packages that provided them extra knowledge for fast and accurate problem solving. Simulations helped them with better understanding of the world around them. Moreover, students find these novelties in presenting practical knowledge amusing and useful.

We plan to include these project activities in the courses in coming years, too. We also want to include students into some detailed questionnaires in order to get even more profound understanding of the project's impacts and benefits.

#### REFERENCES

- [1] [http://www.vts-zr.edu.rs/images/stories/Projekti/virtuelna\\_laboratorija\\_fizike/virtuelna\\_lab\\_fizike\\_projekat\\_vtsszr\\_22092021.pdf](http://www.vts-zr.edu.rs/images/stories/Projekti/virtuelna_laboratorija_fizike/virtuelna_lab_fizike_projekat_vtsszr_22092021.pdf)
- [2] <http://www.vts-zr.edu.rs/index.php/16-nastava/sednice4/79-fizika>
- [3] <https://classroom.google.com/w/NDAXMjEyNjcxNTMw/t/all>
- [4] <https://phet.colorado.edu/en/simulations/filter?subjects=physics&type=html&sort=alpha&view=grid>
- [5] [http://www.vts-zr.edu.rs/images/stories/Predmeti/Fizika/virt\\_lab\\_fizike\\_01102021/virt\\_lab\\_fizike\\_uputstva\\_simulacije\\_01102021.pdf](http://www.vts-zr.edu.rs/images/stories/Predmeti/Fizika/virt_lab_fizike_01102021/virt_lab_fizike_uputstva_simulacije_01102021.pdf)
- [6] [http://www.vts-zr.edu.rs/images/stories/Predmeti/Fizika/virt\\_lab\\_fizike\\_01102021/virt\\_lab\\_fizike\\_uputstva\\_za\\_izradu\\_grafika\\_fit\\_linear\\_exp\\_log\\_polynom\\_funkcije\\_01102021.pdf](http://www.vts-zr.edu.rs/images/stories/Predmeti/Fizika/virt_lab_fizike_01102021/virt_lab_fizike_uputstva_za_izradu_grafika_fit_linear_exp_log_polynom_funkcije_01102021.pdf)
- [7] [http://www.vts-zr.edu.rs/images/stories/Predmeti/Fizika/virt\\_lab\\_fizike\\_01102021/virt\\_lab\\_fizike\\_zadaci\\_fit\\_lin\\_exp\\_log\\_polynom\\_funkcije\\_01102021.pdf](http://www.vts-zr.edu.rs/images/stories/Predmeti/Fizika/virt_lab_fizike_01102021/virt_lab_fizike_zadaci_fit_lin_exp_log_polynom_funkcije_01102021.pdf)
- [8] [http://www.vts-zr.edu.rs/images/stories/Predmeti/Fizika/virt\\_lab\\_fizike\\_01102021/virt\\_lab\\_fizike\\_data\\_analysis\\_excel\\_01102021.pdf](http://www.vts-zr.edu.rs/images/stories/Predmeti/Fizika/virt_lab_fizike_01102021/virt_lab_fizike_data_analysis_excel_01102021.pdf)
- [9] <https://www.xlstat.com/en/>
- [10] [https://help.xlstat.com/s/article/statistics-webinar-recordings?language=en\\_US](https://help.xlstat.com/s/article/statistics-webinar-recordings?language=en_US)
- [11] <https://www.wolframalpha.com/>
- [12] [http://www.vts-zr.edu.rs/images/stories/Predmeti/Fizika/virt\\_lab\\_fizike\\_01102021/virt\\_lab\\_fizike\\_uputstvo\\_za\\_rad\\_sa\\_programom\\_wolframalpha\\_01102021.pdf](http://www.vts-zr.edu.rs/images/stories/Predmeti/Fizika/virt_lab_fizike_01102021/virt_lab_fizike_uputstvo_za_rad_sa_programom_wolframalpha_01102021.pdf)
- [13] <https://www.geogebra.org/>

# Methodological Approach to Electricity Production within the Field 'resources and Production' in 8<sup>th</sup> Grade of Primary School

S. Jokic\*, A. Ilic\*\*, M. Hadzic\*\*\*, V. Srdić \*\*\*\*

\*Technical Faculty 'Mihajlo Pupin', Zrenjanin, Serbia

\*\* Primary school 'Miroslav Antic, Belgrade, Serbia

\*\*\* Primary school 'Vasa Carapic', Belgrade, Serbia

\*\*\*\* International univerziti in Novi Pazar  
aleksandra.ilic79@gmail.com

**Abstract** - The aim of this paper is to present the selected modern methods and new methodological approaches in teaching the subject of Technics and Technology. The paper presents the organization of a lesson on the topic of Electricity generation using various modern teaching methods: project learning, problem - based learning, teamwork, flipped classroom, cooperative learning, teaching based on competencies, in conjunction with simulation and animation. The current moment in teaching implies the mandatory use of ICT, which means that teachers are continuously being trained to apply a large number of ICT tools. The paper shows how the teacher effectively uses ICT in each phase of the lesson, in order to achieve outcomes and improve students' competencies.

## I. MODERN METHODOLOGICAL APPROACH TO TEACHING

The current moment in teaching implies the mandatory use of ICT. This means that teachers are continuously trained to apply a large number of ICT tools. The complementary approach involves the use of ICT as an aid and active support to students' efforts in accepting teaching content. By applying these approaches, students are enabled to download the content of the lecture from the computer, use e-mail at home and at school, search various sources online and fulfill the required tasks. The application of ICT in technical education of students implies the application of ICT in conducting lectures, demonstrations, laboratory experiments, multimedia, simulations, diagrams, application software, etc. A digital classroom is used, with a sufficient number of computers, a smart board, a projector and other adequate teaching aids.

Classic textbooks, e-learning contents, e-books, e-applications for simulation and games, e-learning, and everything else that contributes to a successful class are used. E-learning increases students' technical education by using a variety of e-

resources, online courses, blended learning, the use of lecture management systems, and other communication and collaboration tools. Lecture management systems have the possibility to deliver content, email, assignments, manage forums, mailing lists, surveys, self-assessments, chats, calendar, frequently asked questions and answers, design blogs, manage video conferences, various glossaries, lead student portfolio, student tracking podcast, etc. If there is no management system, Team viewer, can be used, or MS Lync, or some other similar tool. Other web tools such as SkyDrive, MS Office 365 for education, Google Docs, can be used for other forms of work such as seminar work, reports, etc. Social networking tools and sites such as Facebook, Google Talk, Skype, etc. can also be used. The impact of these tools has been shown to be positive on student learning outcomes through online teaching [1]. The complexity of introducing new methods and approaches requires previously well-mastered IT skills that allow for less effort in embracing innovation in education.

## II. MEANINGFUL LEARNING WITH TECHNOLOGY

Technology has entered education and contributed to a change in the approach to teaching. In order for students to be involved in meaningful learning, they must be involved in a task that requires them to think and find possible solutions, with appropriate argumentation. Technology can be used to encourage meaningful learning, rather than as a simple medium for transmitting information. It is needed for the purpose of comprehensive, engaged and easy thinking. The role of technologies that support meaningful learning in the lesson

presented here is multiple: as a tool to support knowledge building; to present students' ideas, understandings and beliefs; to access the necessary information; to compare perspectives, beliefs and worldviews; to present and simulate significant problems, situations and contexts in the real world; to help students articulate and present what they know.

### III. METHODOLOGICAL APPROACH TO ELECTRICITY GENERATION WITHIN THE FIELD 'RESOURCES AND PRODUCTION'

Within the subject TECHNICS AND TECHNOLOGY, which is taught in the 8th grade, the introduction of the teaching contents of the chapter RESOURCES AND PRODUCTION is planned, with 20 lessons in total.

This chapter provides 6 lessons for the topics: Power system; Electricity production, transformation and transmission; Renewable electricity sources. The teacher preparation would initially consist of determining outcomes, content, and gathering the necessary materials and information related to the topics covered. Not all outcomes are of the same weight, they differ, so it is necessary to determine the time needed for their implementation. After sorting the material, the teacher would determine which method is most suitable for processing the topics. It would take into account the complexity of each method. Students' prior knowledge can be crucial in choosing a method of work. This means that he must know what each method brings, how to approach the topic, determine key issues, determine the starting platform for starting conversations with students, determine the initial content to introduce students to the situation, determine the way of verbal communication with students.

### IV. IMPORTANCE OF NEW TEACHING METHODS

Student success in education is directly related to the methods used by teachers and students. Many of the methods used are under scrutiny and are constantly being reviewed. Through the application of methods, teachers guide, lead, help and support the research and cognitive activity of students. This includes encouraging students to ask questions, responding appropriately to their answers, encouraging them to accept challenges and disagreements, discussing through contradictions, and offering creative solutions.

During this lesson, the teacher opted for the following teaching methods: flipped classroom; project learning; cooperative learning; problem teaching; competency-based learning; learning through play and simulation; challenge-based learning.

### V. METHODOLOGICAL APPROACH TO ELECTRICITY PRODUCTION IN THERMAL POWER PLANTS

This way of electricity production is introduced through presentation, i.e. the flipped classroom is used. A simple definition of a reverse approach to the classroom is given by the sentence *What is done at school is done at home, and homework at home is done at school* [2]. Before the lecture, students watch the theoretical part of the class through a presentation, online video, learning management system, and prepare questions so that they could clarify what they do not understand. During the lessons, accompanying activities are solved in the form of jointly finding answers to questions prepared before class. This method requires a longer period of preparation of certain teaching contents. It requires knowledge of working in multimedia resources and working in an LMS environment. The teacher must be perfectly acquainted with the work in the technique Screencasts (Screencasts are recordings that record audio narration together with images from the computer screen), in order to have more time for other necessary activities in the preparation of lessons. The teacher records her video presentation or transfers the recorded video or simulations of the operation of thermal power plants from the website. Continuous dynamic simulations are used in game simulation (flight simulators). Computer graphics and simulation are an ideal combination for graphical display and visualization. The simulation provides information, can demonstrate the phenomenon through a model, and allows practice in learning, examination and testing of knowledge with feedback on the result.

It is recommended that the presentations last a maximum of 10-12 minutes, because with longer duration, the concentration of attention in students decreases sharply. During the presentation, the teacher asks one leading or motivational question: How to improve the operation of coal-fired power plants to emit smaller amounts of harmful gases?

After being asked this or more similar questions, students' attention to the presentation is activated, so they more readily engage in watching and listening with the task to find the most important information and recognize the concept of coal-fired

power plant, and to find places and details that are not clear. If she wants to know more about what the students remembered by watching and listening to the presentation, the teacher can sequentially ask interpolated questions which retrieve memory. They contain a few short but essential questions about a coal-fired power plant. Student group activities are one of the goals of a flipped classroom. Each student comes to class with their own concept of understanding the content of the thermal power plant. Through joint discussion, mutual knowledge and understanding of materials, a new, more complete and meaningful understanding of electricity production in coal-fired power plants is reached.

Mini-test with questions:

- Why are thermal power plants built next to larger rivers?
- What is the difference in the construction of the boiler in the bathroom from the large boiler in the thermal power plant?
- Explain the operation of a turbine in a coal-fired power plant.
- How is the electricity produced from the coal-fired power plant transferred to the transmission system?

In this way, the teacher finds out how much new knowledge each student has acquired.

The combination of different approaches in evaluation does not always have to be given through a numerical value, but also appreciates the effort and effort invested in understanding the concept of operation of a coal-fired power plant. It is important to note that students have always been active in class work, and that the teacher with her questions and sub-questions directed the course of discussion to the desired outcomes.

## VI. METHODOLOGICAL APPROACH TO ELECTRICITY PRODUCTION IN NUCLEAR POWER PLANTS

The teacher explains to the class that she will form several groups of students, usually three to five students in a group, and explain to each group the further procedure in the work. She gave one of the groups the task to explain the way of electricity production in nuclear power plants, through the method of cooperative learning. Cooperative learning is a type of teaching practice that allows students to learn together in small groups. Groups are formed in such a way that the members of the group must cooperate with each other in order to succeed. Each participant in the group is responsible

for their own learning as well as for the learning of the other members of the group.

When she has finished forming the groups, the teacher addresses the group that has been given the task to explain how electricity is obtained in nuclear power plants. It begins with a short introductory lecture, what is nuclear energy, when it was first applied.

At the end of the introductory lecture, she explains the goals that are to be achieved by learning certain material. Objectives are formulated as learning outcomes or learning results: at the end of this unit the students will be able to explain how electricity is produced in nuclear power plants.

In order to better understand the material, the teacher explains the basic concepts and new concepts, gives instructions on how to work. They are given in written form, not too complex, so that the students have as much space as possible for mutual discussion.

Since in the era of the digital revolution access to information is easy, the teacher suggests to students how to find certain information on the Internet. It is important to note that the teacher contacts only the elected group leader or the informal one who stands out in the group representing the interests of the group with the teacher.

Each member of the group was given their own task. The first member has the task of explaining the basic principles of nuclear energy, and the second one the way the nuclear reactor works. The third member of the group has the task to explain the principle of operation of the turbine and generator. The fourth member of the group was tasked with clarifying ways to protect the environment and handle nuclear waste.

The teacher periodically checks how the work process is going, intervenes if there are any disagreements. The goal is not only for students to get the highest grade, but to feel like a team member who contributes to the success of the whole team, to gain social skills and respect the opinion of each group member, to jump in and help a team member if he has any difficulties.

Finally, when the group completes the work, the teacher selects one member of the group to present the work in front of the whole class; the other students lavish the student with questions and give their grade for the work. The teacher concludes with an assessment of the work of the group, their behavior within the group, assesses how much they

have accepted social skills, points out some misconceptions and gives a way to correct them, praises students for their efforts as a contribution to further work.

#### VII. METHODOLOGICAL APPROACH TO ELECTRICITY PRODUCTION IN SOLAR POWER PLANTS

One of the teams of students was given the task to solve one specific problem through the method of problem-based teaching. In problem-based teaching, students are asked to solve a real-life problem. Learning takes place while solving the problem together. This process includes three basic functions: searching for information, generating new knowledge, and making decisions.

The team is composed of three students. The teacher told them that there are many problems in society that can be solved by applying solar energy. Their task is to discuss and find a certain problem from their environment that can be solved by applying solar energy. The students gave numerous ideas and finally agreed that they could give a solution to the problem of the electricity needed to operate the large lawn watering system in front of their school. The teacher agreed with the idea and referred them to possible problems. The first problem is whether they fully understand the nature of the problem and what the goals are to be achieved. It is necessary for all students to have a work diary in which they would write down all activities that would be a reminder for further work.

In their notebooks, they wrote down the obstacles that need to be overcome in order for the problem to be solved. One student took on the task of informing the rest of the team on the principle of the systems for obtaining electricity in solar power plants, i.e. converting solar energy into electricity. The teacher directed him to the necessary literature and information on the Internet.

From the possible solutions, they chose a home solar system, and the panels would be installed on the roof of the school. The students chose the network solar system, because the school works in one shift and only during the day. Since there is no need to consume electricity during the night, the excess electricity is sent to the network. The panels on the roof are at an angle in order to make the best use of the possibilities provided by the sun.

The second student is in charge of finding on the market all the necessary products for solar systems connected to the network. Due to the diversity of the market, the student consults with the teacher what

are the best requirements to select certain elements. The third student is in charge of explaining the advantages and disadvantages of using solar energy as well as the impact on environmental protection.

When the students have collected and sorted the information, they reconsidered whether there were any other solutions. If not, they access the final report. The report is read in front of other students and additional questions from students are expected. The teacher evaluates the effort and analyzes the approach to the students' work, and if there are any doubts, she tells them in good faith how to avoid them in the following tasks.

#### VIII. METHODOLOGICAL APPROACH TO ELECTRICITY PRODUCTION FROM WIND ENERGY

The teacher gave one of the teams the task to write a paper on obtaining electricity from wind energy using a competency-based teaching method. This method makes it possible to imitate the way people learn and work. Here, the focus is on competencies and learning outcomes, which help teachers to create content and assessment methods, and help students understand what they are working on and how to progress. It is important to point out that with this method students make their own decisions about what, when, where and how to learn

Before the students started working, the teacher had to prepare the basic elements for this method. Since the method is based on the acquisition of knowledge at certain levels, the teacher prepared the initial literature for the team and gave them the freedom to choose other literature of their choice. She explained to them that they will have to cooperate as a team and follow each other in the acquisition of knowledge for a certain level. After checking the acquired knowledge through a discussion or a short test, the next level is approached, which is more difficult than the previous one. When students assess that they have met all the requirements that exist at the given levels, they start writing the final report for the given task. This can be a combination of a competency-based method and teamwork method, with a focus on competencies. With this more complex approach, students have great independence in choosing their pace of learning, but they also learn to work in a team. Students determine the pace of work and the moment when they think they have acquired new knowledge. The teacher re-checks the student's knowledge orally by asking short questions, or by taking a short test.



After being allowed to write the paper, students form the final version of the paper, defending the paper in front of the whole class. Taking into account the opinion of the rest of the class, the teacher gives the final grade to the work, noting that the final grade is determined by the effort and work and a systematic approach to work.

### IX. METHODOLOGICAL APPROACH TO ELECTRICITY PRODUCTION IN HYDROPOWER PLANTS

This type of electricity production is introduced by the method of project learning. Here, students work individually or in small groups, analyze and develop a real-life problem or deal with a current topic within a predetermined deadline, working independently and with a clearly defined division of tasks [3]. The main focus is the socialization of students and the development of problem-solving skills.

Here it is necessary to implement six steps that will determine further work in the classroom. Before starting the first step, the teacher makes an introductory scenario to suggest to the students the topic of the work. Students are reminded that energy was discussed in the fifth grade, about renewable and non-renewable energy sources. The introductory presentation on electricity follows and the types of sources from which electricity can be obtained. Which scientist is responsible for the progress of civilization in this field? Nikola Tesla's merits for the development of science and technology. Which of his inventions are the basis of today's way of life? Finally, the teacher explains to the students what an electric power system is, what its subsystems are. All the time the conversation takes place in the form of teacher asking questions and students giving answers. The first step is to create a situation from which the other steps follow. Creating a situation: From talking to students and their answers, the teacher already has in mind what the title of the project would be for a given team of students. It is important that the students themselves get the impression that they have created the title of the project and that they are proud of it. Student guidance takes place through a series of questions to which students give answers that would match the expected answers.

The title of the project is a summary of these answers and the created situation, which is also step 2: The impact of the regulation of river watercourses on the production of electricity in hydroelectric power plants.

The third step is planning: In this phase of work, students lead discussions in a team, plan how to start work, draw conclusions. The teacher suggests to them what problems may arise in the work, about the limitations of information resources, which sources of information to use ... Finally, in their workbooks they write down what was agreed, how to start work, and describe in detail the further work plan.

The next, step four, is the implementation of the project: A schedule of work and tasks is made according to the abilities of each team member. All information relevant to the project is collected and sorted. Answers to the question of river flow regulation are sought. Particular attention is paid to the choice of turbines in generators and how to increase their efficiency, the impact of a large amount of water on the operation of turbines, the impact of a small amount of water on the operation of turbines.

The fifth step is evaluation: The students in the team gathered and found answers to all questions related to the project. The content has been systematized, reviewed, language corrections have been made and it is ready for publication. Each student evaluates their performance and writes it in the project book.

The sixth step is the project report, i.e. recording: The teacher receives a report on the completed project, compares her observations with the students' observations from the project book and gives her final grade about the project. The project can be exhibited and a public debate conducted in the local government, because it concerns the local government itself, or in the school in front of the school auditorium. The students from the team are publicly praised for their effort.

### X. CONCLUSION

The aim of this paper is to present selected modern methods and new methodological approaches in teaching Technics and Technology. The paper presents the organization of a lesson on the topic of electricity production using various modern methods. A common feature of all the methods used here is challenge-based learning. The framework is collaborative and practical, and requires all participants to identify great ideas, ask good questions, discover and solve challenges, gain detailed knowledge in the teaching area.

It is difficult to implement all this with traditional learning methods. They still have their place in the work of teachers, but progress inevitably imposes the acceptance of new

approaches to the organization of teaching. The emergence of many new methods and methodological approaches suggests that a large number of teachers and researchers have become involved in the process of improving teaching processes. Teaching practice has given rise to several modern methods that have become established in the educational process. In the 8th grade, the educational contents of electricity production in the field of resources and production showed that several methods can successfully involve students in active learning and increase their interest in learning.

Since these methods require students to be more engaged in class, which results in the development of cognitive abilities, it is therefore recommended to use them in teaching. The role of the teacher is changing. Now she organizes, directs, supports, helps students' research activity. The student is at the center of the educational process. In order for a student to acquire knowledge successfully, he must meet certain requirements such as a versatile approach to cognitive tasks, curiosity, tolerance, studiousness, a realistic attitude towards his own

and others' abilities, and self-criticism. The student must develop powerful habits of the mind, because only then can he think critically, and exercise creative thinking.

The teaching content of the subject Technics and Technology is very diverse and provides great opportunities for the application of ICT, which can lead to the improvement of the educational process and easier achievement of the outcomes of teaching TT.

#### REFERENCES

- [1] Pallavi S. ( n d). Project Method.
- [2] Ozdamli F, Aşiksoy G. (.2016) Flipped Classroom Approach
- [3] Banday, M,T, ( 2012). e-Learning in Web 2.0 World: A Case Study
- [4] Tasić I, Glušac D, ( 2019). Metodika nastave tehničkog i informatičkog obrazovanja,TFZR Mihajlo Pupin, Zrenjanin
- [5] Bloom S.B. ( 1070).Taksonomija i kalsifikacija obrazvonih i odgojnih ciljeva , Beograd
- [6] Popov S:, Soro M. , ( 2015).Metodika tehni;kog i informati;kog obrayovanja, Zavod za udžbenike, Beograd.
- [7] Ivanović B. ( 2018). Izekrenuta učionica- pedagoški model koji menja koncept tradicionalne nastave, Ekonomski signali 13(1)

# Modernization of Mathematics Education by Using Educational E-platforms

L.K. Lazarova\*, M.Miteva\*, A.Stojanova\*

\* University “Goce Delcev”/Faculty of computer sciences, Stip, Macedonia  
e-mail address: limonka.lazarova@ugd.edu.mk, marija.miteva@ugd.edu.mk,  
aleksandra.stojanova@ugd.edu.mk

**Abstract - Mathematics is not popular subject among students because in the most of cases the teachers use traditional methods and complex approach in the presentation of the content. On the other side, we are living in digital era when the computers and smart phones are included in all spheres in the life. The challenge of the modern educational process is to include the multimedia and interactive materials. The educational e-platforms for studying mathematics are helping teachers and students at the same time. The teachers can analyze the students’ success after every lesson and can adapt the materials for their needs, students can communicate with the other students and teacher. However, there is a lack of such materials especially in our and the neighbor countries. The main aim of this paper is to analyze the situation about such educational e-platforms for studying mathematics in Macedonia and neighbored region.**

## I. INTRODUCTION

Well-known fact is that mathematics is essential subject in the students’ educational process, meaning that achieving math knowledge is crucial for correct and easy studying of the other subjects, and more of that, it is crucial for dealing with different everyday situations. However, also well-known fact is that students usually do not find math easy for studying and understanding. The number of students that need help in achieving math knowledge and doing math tasks is significant bigger than the number of talented students and those who can do math without help. We believe that each math teacher makes efforts to introduce math material in a way convenient for the students’ age and gives all to contribute in overcoming students’ difficulties in the process of learning math. We can face-up with different new methods regarding math-teaching methodology developed in order to improve the above-mentioned situation with the students’ attitude toward mathematics. Different papers for presentations and different ways and tools for visualization in the classroom used before the digital era are changing and nowadays we can see

different e-technologies in the classrooms, in order students to understand math easily (for example, see [1]). However, the implementation of these e-tools in the process of school learning, in Macedonia and neighborhood is not going so fast.

The development of the technologies nowadays could change the habits of the students and the teachers in the schools. The digital era is emerging so the books and handbooks in the schools could be substitute with new modern materials in electronic form: videos, quizzes, tutorials, interactive tools etc. Can the learning platforms be a started point to do revolution in the education and learning process? Obviously, yes. The learning platforms can change the traditional meaning of the words “study” and “learning”. Such e-learning platforms have more consequences that are positive [2]:

- Increased motivation because the e-learning platforms offer more visible and dynamic contents;
- Socialization because the students communicate with other students by using the tools in the e-platform like forums, chats, virtual classrooms.
- Students develop more technological skills, which is essential in these days of digital era.
- Students learn how to manage all the information and time needed for some activities.
- Students learn how to be more responsible and how to estimate their own knowledge by using of the electronic test, quizzes, contextualized problems.

There are many examples of e-platforms for e-learning mathematics in the USA and Europe, but most of them are not open sources. There are some mathematical platforms for e-learning of the specific contents especially in the higher education, [3]. In this paper is concluded that

the e-platforms are making mathematical learning more interesting, meaningful and applicable to the learners beyond the classroom knowledge. Also, in [4] is consider the Genie 3 platform. After researching, the authors concluded that the use of such kind of platforms increased the students' engagement and personalization, capturing students' attention, fostering deep learning, and minimizing cognitive load, which leads to improved engagement, and ultimately better educational outcomes.

## II. SITUATION IN MACEDONIA AND THE NEIGHBOUR COUNTRIES

Besides all these positive aspects for using of the electronic platforms for e-learning, the situation in Macedonia is not satisfactory. The conducted research in 2011, [5] and [6], shows that there are few e-platforms such [7] which offer e-learning of mathematics, but most of them are not active now. Other e-platforms active at the moment in Macedonia like [8], [9], [10] and [11] offer mathematical lessons in electronic version, tests and lesson plans for the teachers, but they don't offer videos, tutorials, interactive contents which will enable possibilities for communication, explanation and finding solutions of the problems through debates and forums. In [12] we can see only few videos (about 15 until now, available via the YouTube channel [13]), for certain math problems, with explanations, some of them for secondary school students and the other for university students. These videos cover very little percentage from the math material and problems that students are facing-up. Furthermore, there are no videos for students in primary school. On [14] we can see few video explanations for the problems regarding operations with numbers and power calculations, which is also very little percentage of the math material in primary school. In [15] is shown the impact of the video lectures in increasing the students' interest in the process of learning mathematics, but there are no available video lectures.

Moodle Platform is used by some universities in Macedonia, but this e-platform has not been made adaptive for primary or secondary schools in Macedonia. It is necessary to find and construct e-platform, which will be in some way substitution of the math teachers when the students are not at schools. This e-platform will enable students to do their homework and projects without asking help from their parents or taking tutoring.

In Serbia the situation about mathematical e-platforms is better than in Macedonia. In [16] it is shown that the level of available e-materials for mathematics education in Serbian language, designed by GeoGebra Centre Belgrade are different and it depends from the age of the students. In Serbia, the level of such materials for kindergartens is low, the materials for primary schools are at satisfying level, but materials for high school, undergraduate and applications of mathematics are large-scaled. The Moodle platform is used in Serbia also at higher levels of the education. There is many e- platforms in Serbia, which are not free for using such [17], some of them offer private classes like [18] and [19]. The most of e-platforms contain only materials such lessons, tests and plans [20], but some of them have video tutorials [21], [22] and [23].

In Croatia, the situation related to the electronic educational platforms is similar as the situation in Serbia and much better than the situation in Macedonia. In the last few years in Croatia has started a project Skole 2.0 which was funded in high percent by the European Union. This project is implemented in collaboration with CARNet together with its partners Samsung, HP, Microsoft. The main goal of this project is to make the classroom in Croatian' schools as "future classrooms". That means that the students in a close future can go to the schools without heavy bags full of books and other printed materials. The tablet or computer will be enough to satisfy all their needs, because everything will be in electronic version. The project covers many school subjects, but the teachers have many remarks about not enough innovative approach for mathematical materials.

There are many e-platforms which offer mathematical materials in electronic form for the students in primary and secondary schools and the lesson plans for their teacher, but without videos, forums and quizzes. In [25] which is developed for Android, iOS and Windows and in [26], [27] are presented such kind of materials.

[28] is an educational e-platform for mathematics developed in Croatia in English language aimed to the students in primary schools. This e-platform offers videos and classification of the materials depending of the mathematical area (algebra, geometry) and the grade.

Also, there are many other applications developed in Croatia which are many popular among the students all over the world such as [29], which help the students to solve the mathematical

problems when they must do their homework alone, without teacher's help. But this application is only solver of the mathematical problems. It does not contain more possibilities like the educational platforms. However, it can be concluded that the situation in Croatia is much better than in the other neighbor countries. They have much support of the EU in the part of education, especially for its modernization by including of computers and other digital technologies.

In Slovenia, also there are many educational mathematical platforms. Slovenia like EU member disposes with financial support for this kind of activities. [30], [31], [32], [33], [34] and many others offer videos, instructions, games and tests for students in primary and secondary schools. [35], [36] are only web sites for private lessons and instructions. [37] is Android application with video instructions and exercises in mathematics for young students in primary school. Slovenia disposes with plenty of this kind of educational mathematical platforms for students in primary and secondary schools, but not for the students at the faculty level.

Macedonian Students' needs and opinions about educational platforms

In order to analyze the real situation in our country, we have proceeded a questionnaire for the students in our University who studied mathematics as a course at the faculty. The questionnaire consists of ten questions, which refer to the use of educational e-platforms in the process of teaching mathematics. 89 students from different faculties (58,4% from Faculty of computer sciences 28,5% from Faculty of technology and 13,1% from Faculty of Educational Sciences) at our University responded the questionnaire. The sample was chosen arbitrary but taking into account that the students at the Faculty of computer sciences studying the most mathematics in their studies, after that the students at the Faculty of technology who studying mathematics in only two subjects in the first year and the students of Faculty of educational sciences who studied mathematics least, only in one subject in the first year of the faculty.

At the first question: How often do you need additional help to explain specific mathematical concepts?, the most of the students 52% said that very often they need additional help for studying mathematics and only 13% said that rarely used additional help after the classes at faculty. That shows that the lectures and exercises at the faculty are not enough for most of the students. Therefore, they need additional tutoring or some other

instructions in order to obtain the necessary knowledge to pass the exam and to apply in other sciences. Considering that nowadays we are living in digital era, we appoint the next question: Do you use computer technology for further explanation of mathematical concepts? On that question 40% responded that they use computer technology very often, 36% used it rarely. The next question in the questionnaire was: What do you usually use to get additional explanations for some mathematical concepts? The answers are given on the next pie graph and shows that most of the students do not use electronic platforms. They usually get to use Youtube tutorials where they are watching video instructions and classes and Mathematical forums where can communicate with other students and professors.

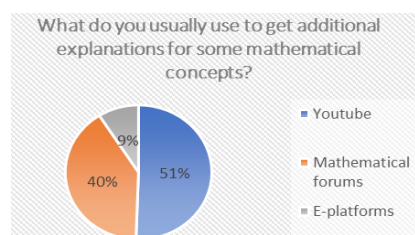

Figure 1. Pie of the answers

For the students, computer tools for geometrical drawings, constructions and graph plotting are unknown. Even 91% do not use the possibilities of these computer tools, which are very helpful during solving of the posted mathematical problems.

Also, they very rarely used online applications to check the acquired mathematical knowledge. Even 82% answered that rarely or never used online tests to assess their mathematical knowledge.

The last two questions in the questionnaire were:

- Do you think that in Macedonia there is a lack of material in Macedonian language in electronic form for studying mathematics?
- Do you think there is a need for creation of an electronic platform that will offer videos, images and texts for better explanation of the mathematical concepts?

The answers are given to the next two pies:

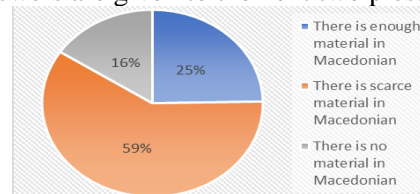

Figure 2: Answers of the question: Do you think that in Macedonia there is a lack of material in

Macedonian language in electronic form for studying mathematics?

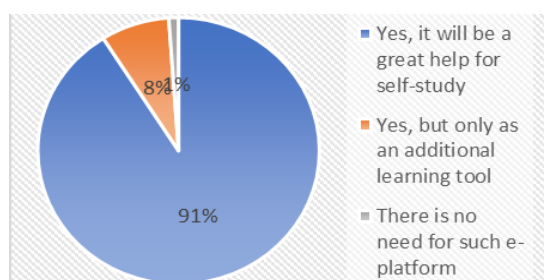

Figure 3: Answers of the question: Do you think there is a need for creation of an electronic platform that will offer videos, images and texts for better explanation of the mathematical concepts?

From graphical presentation in Figure 2 it can be seen that very high percent 75% of the students have answered that there is not enough material in Macedonian for studying mathematics, even 59% percent of them thought that the electronic mathematical material in Macedonian is poor. It is obvious that there is a need of development and preparation of mathematical material in electronic form in their native language. There is a great need to create an electronic platform. Although 91% of the students think that the existence of educational mathematical e-platform will be wonderful help for self-study. 8% said that it will be helpful as an additional tool.

Also, with ANOVA analysis (Table 1) we have concluded that the students' opinion about neediness of educational e-platform not depends of the faculty on which they study. Almost all of them would be grateful if they have possibility to study, discuss and communicate in such e-platform.

TABLE 1. ANOVA RESULTS

ANOVA						
Source of Variation	SS	df	MS	F	P-value	F crit
Between Groups	0.047	2	0.023	0.572	0.566	3.107
Within Groups	3.352	83	0.040			
Total	3.3983	85				

That shows that development of the educational e-platforms, especially for mathematics is necessary for students' requirements independently of the type of their studies. The specific and complex nature of the mathematics as a science look for such helpful tool for the students, who use the computer and digital technology in their everyday lives. On this way they can study mathematics at their homes after the classes without taking tutoring. The educational e-platforms will contain video tutorials for the

students who miss class for some reason. It will contain forums for debates, discussions and finding help for some problems. The quizzes and test will be included for checking of their knowledge. Also, it can be included some tool for geometric illustrations and constructions. In one sentence, the e-platform will be the place where everything which is necessary for studying of some mathematical material will be accessible for every student.

### III. CONCLUSION

From the conducted analysis it can be concluded that the situation with existence of educational e-platforms at the Balkan, especially in Macedonia is not on high level. The countries which are part of EU have many opportunities for developing of such educational platforms and on that way, they can extend the barriers in the educational process. The worst is the situation in Macedonia. The students have demands for increasing of the computer and mobile use for educational goals. They need such educational e-platforms, not only for mathematics, but for the other subjects because in nowadays when everything is available on internet, the students can study alone, but only if the material is prepared in proper form. The students say they do not have enough material in electronic form and that the existence of an electronic platform for studying mathematics is needed. The possibilities of that kind of platform are huge. Everything that is needed is to include our students at the Faculty of computer science to use their knowledge and to develop such software solution for all students' good. The neighbor countries are excellent examples for that how the things should be appointed.

### REFERENCES

- [1] <https://www.microsoft.com/en-us/microsoft-365/blog/2015/05/26/how-a-macedonian-teacher-incorporates-mobile-technologies-and-onenote-in-her-classroom/>
- [2] <https://www.cae.net/learning-platform-learning-habits/>
- [3] J. Y. Ahn and A. Edwin, An e-learning model for teaching mathematics on an open source learning platform, International Review of Research in Open and Distributed Learning, Volume 19, Number 5, 2018.
- [4] K. Mulqueeny, V. Kostyuk, R. S. Baker, J. Ocumpaugh, Incorporating effective e-learning principles to improve student engagement in middle-school mathematics, International Journal of STEM Education, 2015.
- [5] <http://metamorphosis.org.mk/wp-content/uploads/2014/09/Sostojbata-so-e-uchenjeto-vo-Makedonija.pdf>
- [6] <http://metamorphosis.org.mk/wp-content/uploads/2014/09/report-oer-en-2010-1.pdf>
- [7] <http://www.skool.mk/>
- [8] [www.matematirame.weebly.com](http://www.matematirame.weebly.com)
- [9] [www.veselaucilnica.ucoz.com](http://www.veselaucilnica.ucoz.com)
- [10] [www.sites.google.com/site/vezbajmatematika](http://www.sites.google.com/site/vezbajmatematika)
- [11] <http://matematika.mk/>
- [12] [www.e-matematika.mk](http://www.e-matematika.mk)

- [13] [https://www.youtube.com/channel/UC24OIpMc\\_iU\\_EdZXq6yYdAw/videos?disable\\_polymer=1](https://www.youtube.com/channel/UC24OIpMc_iU_EdZXq6yYdAw/videos?disable_polymer=1)
- [14] <http://lesnamatematika.com/matematika/>
- [15] <https://matematika-plus.weebly.com/zgolemuvanje-na-interesot-za-matematika-so-video-lekcii.html>
- [16] J. Jezdimirović, Computer based support for mathematics education in Serbia, International Journal of Technology and Inclusive Education (IJTIE), Volume 3, Issue 1, June 2014.
- [17] <http://matematika.edu.rs/>
- [18] <https://lammasi.com/>
- [19] <http://www.brzedoznanja.com/ser/>
- [20] <http://anicatr.weebly.com/srbija3.html>
- [21] <https://www.ucislobodno.com/>
- [22] <http://www.rajak.rs/sr/video-lekcije>
- [23] <https://matematikanac.com/>
- [24] <https://www.futureschool.com/turkey-curriculum/>
- [25] <https://edutorij.e-skole.hr/share/page/dos-enskole?school=osnovna&schoolClass=sedmi&subject=matematika>
- [26] <https://www.e-sfera.hr/>
- [27] <https://www.artrea.com.hr/matematika.html>
- [28] <http://www.eduvizija.hr/portal/>
- [29] <http://e-laboratorij.carnet.hr/photomath-alat-koji-matematiku-cini-jednostavnom/>
- [30] <https://astra.si/>
- [31] <https://moja-matematika.si/>
- [32] <https://interaktivne-vaje.si/>
- [33] <http://razrednipouk.weebly.com/matematika1.html>
- [34] <https://www.ucimse.com/>
- [35] <http://instrukcije-eva.si/>
- [36] [https://www.google.si/instrukcije/matematika?gclid=CjwKCAjw0N3nBRBvEiwAHMwvNj8buMmxmik72eW4MnO9Gbdkc2yoznTa\\_4vNosaHvRrYkxJBOSx4-hoCS18QAvD\\_BwE](https://www.google.si/instrukcije/matematika?gclid=CjwKCAjw0N3nBRBvEiwAHMwvNj8buMmxmik72eW4MnO9Gbdkc2yoznTa_4vNosaHvRrYkxJBOSx4-hoCS18QAvD_BwE)
- [37] <https://www.otroci.org/programi/poucniprogrami/ucni-listi-za-vse-razrede-o-s>

# Dynamic Social Network Analysis Visualization Software: A Comparative Review

I. Hamulić\*, G. Škondrić\*\*, E. Junuz\*

\* University “Džemal Bijedić”, Mostar, Bosnia and Herzegovina  
indra@fit.ba, goran@fit.ba, emina@fit.ba

**Abstract** - Dynamic network analysis can be used to assess socio-cultural systems from a network perspective. Dynamic view on the social network can be complex. Due to the complex nature of Dynamic network analysis visualization software plays a key role in understanding it. The focus of this paper is on the analysis and comparison of popular visualization software programs for dynamic network analysis. In this paper, we have addressed the various characteristics, functionalities, support comparison, strengths, and limitations of visualization software programs based on a literature survey. This will help researchers and practitioners to choose a suitable tool for social network visualization and analysis.

## I. INTRODUCTION

Social Network Analysis has been used for almost hundred years to represent complex connections within different social groups. From humble beginnings in the 1930s, the SNA has over the years developed an analytical approach and its own methods, theoretical settings, and software for analysis and visualization. The rapid development of information and communication technologies as well as the shift of focus from static to the study of dynamic social networks (DNA) has resulted in developing several tools for analysis and visualization of social networks that are present in today's market. Dynamic social networks are social networks that change over time. [1] The multitude of dynamic and multi-relational data collected from such networks is impossible to understand and even less possible to track the development and changes that occur in a social network over time without serious software for analysis and visualization [2].

In the sea of possibilities offered by software programs designed for DNA, researchers face a number of challenges such as: the ability to automatically import data from various sources, big data analytics, sub-network extraction, community detection, exploring networks and predicting connections, user-friendliness features to represent data, response time, open-source or propriety software, input / output data possibilities, algorithm support and computing centralities, network type

support including temporal networks (network changing over the time), focus on specific nodes and track their evolution, acyclic, multi-relational networks and platform dependency.[3]

In this paper, three software programs for dynamic analysis of social networks will be presented: GEPHI [4] [5], PAJEK [6], UCINET [7]. The choice to present these three tools is based on fact that there are several papers that used analysis and visualization software programs that were published in scientific databases such as Springer, IEEE and Science Direct.

## II. VISUALIZATION SOFTWARE

In this chapter, three software programs will be briefly presented: GEPHI, UCINET and PAJEK.

GEPHI is an open-source standalone software used for network analysis and visualization. [8] One of the most important features of this software is the ability to work with large networks and a large amount of data. GEPHI can read data from plain text files, spreadsheet files but also from databases. This software product creates a network graph relatively easily. GEPHI provides features in order to explore large, hierarchically structured graphs, social communities, biochemical pathways, or network traffic graphs. The software can also filter dynamic structures, such as social networks with the timeline component. But there are some drawbacks.



Figure 1. Network representation using GEPHI taken from [3]



Researchers mostly resent the software's slow response to some simple tasks, and the fact that the set of network analysis tools is very scarce.

TABLE II. STRENGTH AND WEAKNESS

Software	Strengths	Weakness
GEPHI	high quality visualization, knowledge of programming not required	take more time to perform specific task
UCINET	strong centrality metrics	requires windows
PAJEK	strong in analysis	weak in visualization

#### A. UCINET

UCINET is a standalone software for the analysis of social networks, but also for the analysis of cultural domains. [9] This software was developed by Steve Borgatti, Martin Everett, and Lynn Freeman in 2002. Although this software supports network management of two million nodes, in practice it gives the best results in networks of up to 5000 nodes. In UCINET 6.0 version, two types of input and two types of output are used. Input means parameter and input data sets, and output means output text and output data set. UCINET is suitable for the analysis of small social networks and accepts ASCII text files. It also allows multi-layered displays for visualization. It is the software most often used in academic circles.

#### B. PAJEK

PAJEK (Slovenian pajek / English spider) is a software product used for analysis and visualization of large social networks. The software was developed by Vladimir Batagelj and Andrej Mrvar. PAJEK uses six data structures to implement algorithms: network, permutations, vectors, enema, partitions, and hierarchy. This software supports several different network models: temporal networks (network changing over the time), acyclic, and multi-relational networks (multiple relations defined on the same vertices), signed networks (network with negative and positive lines). PAJEK also supports text mining algorithms of social network analysis. When it comes to input, it uses the GEDCOM standard format, and in terms of output, it supports 2D and 3D formats. The most common complaint about this software is its slightly weaker visualization compared to analytics.

### III COMPARATIVE ANALYSIS

In this chapter, a comparative analysis of software products for dynamic analysis of social networks will be presented. It will present its basic characteristics, representation, visualization. Table 1

TABLE I. TECHNICAL REQUIREMENTS

Software	Open-source	Standalone	Platform
GEPHI	yes	yes	Java 1.6 + above, OpenGL
UCINET	no (but free for non-commercial uses)	yes	Windows
PAJEK	no	yes	Windows, Linux, Mac OS

will present the advantages and disadvantages of each of the software products. All three software products can function independently, but only GEPHI is an open-source software. In terms of technical requirements, these three software programs are quite different, and this will be presented in Table 2.

UCINET cannot be installed on any platform other than Windows, while the other two software programs can. GEPHI offers 3D output, unlike the other two types of software. As for the types of visualization for all three software programs, they are presented in Table 3.

TABLE III. VISUALIZATION TYPE

Software	Visualization	Visualization type
GEPHI	yes	graphs, plots
UCINET	yes	graph, plots
PAJEK	yes	graphs

### IV CONCLUSION

Different visualization software programs have their own specific sets of features and tools. It depends on these possibilities and tools how they solve the problem of visualization of dynamic social networks. From a comparative analysis of PAJEK, GEPHI, and UCINET, it can be concluded that GEPHI is a better choice for visualization than for serious network analysis since its metrics are scarce. However, PAJEK is ideal for researching and identifying patterns on social media thanks to its several display algorithms. Both mentioned software programs support the analysis of ordinary social networks. As for UCINET, it is often used in academic environments because it has an extremely rich metrics but its dependence on Windows is a

significant drawback compared to the other two software programs.

#### REFERENCES

- [1] Carley, K. M. 2003. Dynamic networks analysis. In Summary of the NRC workshop on Social Network Modeling and Analysis.
- [2] B. Shneiderman and A. Aris, "Network Visualization by Semantic Substrates", *IEEE Transactions on Visualization and Computer Graphics*, vol. 12, no. 5, pp. 733-740, 2006.
- [3] S. Majeed, M. Uzair, U. Qamar and A. Farooq, "Social Network Analysis Visualization Tools: A Comparative Review," *2020 IEEE 23rd International Multitopic Conference (INMIC)*, 2020, pp. 1-6, doi: 10.1109/INMIC50486.2020.9318162.
- [4] A. Farooq, N. Ashfaq, S. Majeed and S. Ali, "Prediction of Top Trade Leading Countries Through Social Network Analysis Using Hybrid Classification Techniques", *2018 IEEE 21st International Multi-Topic Conference (INMIC)*, pp. 1-6, November 2018.
- [5] N. Aggrawal and A. Arora, "Visualization analysis and structural pattern infusion of DBLP co-authorship network using Gephi", *Next Generation Computing Technologies (NGCT) 2016 2nd International Conference on*, pp. 494-500, October 2016
- [6] D. Yanrui, Z. Zhen, W. Wenchao and C. Yujie, "Identifying the Communities in the Metabolic Network Using Component Definition and Girvan-Newman Algorithm", *Distributed Computing and Applications for Business Engineering and Science (DCABES) 2015 14th International Symposium on*, pp. 42-45, August 2015.
- [7] N. Zhang, Y. Yang and Y. Zheng, "A module partition method base on complex network theory", *Industrial Engineering and Engineering Management (IEEM) 2016 IEEE International Conference on*, pp. 424-428, December 2016.
- [8] M. Bastian and S. Heymann, "GEPHI: An Open Source Software for Exploring and Manipulating Networks", *Proceedings of the Third International ICWSM Conference (2009)*, 2009.
- [9] Y. Wu and Z. Duan, "Social network analysis of international scientific collaboration on psychiatry research", *International Journal of Mental Health Systems*, vol. 9, no. 1, pp. 2, 2015.
- [10] J. Clerk Maxwell, *A Treatise on Electricity and Magnetism*, 3rd ed., vol. 2. Oxford: Clarendon, 1892, pp.68–73.
- [11] I. S. Jacobs and C. P. Bean, "Fine particles, thin films and exchange anisotropy," in *Magnetism*, vol. III, G. T. Rado and H. Suhl, Eds. New York: Academic, 1963, pp. 271–350.
- [12] K. Elissa, "Title of paper if known," unpublished.
- [13] R. Nicole, "Title of paper with only first word capitalized," *J. Name Stand. Abbrev.*, in press.
- [14] Y. Yorozu, M. Hirano, K. Oka, and Y. Tagawa, "Electron spectroscopy studies on magneto-optical media and plastic substrate interface," *IEEE Transl. J. Magn. Japan*, vol. 2, pp. 740–741, August 1987 [Digests 9th Annual Conf. Magnetism Japan, p. 301, 1982].
- [15] M. Young, *The Technical Writer's Handbook*. Mill Valley, CA: University Science, 1989.

# Usability Evaluation Framework for Web Portals of Technical Sciences Higher Education Institutions: a Case Study with Serbian State Universities

Lj. Kazi\*, D. Radosav\*, N. Chotaliya\*\*

\* University of Novi Sad, Technical Faculty “Mihajlo Pupin”, Zrenjanin, Serbia

\*\* Saurashtra University, Rajkot, MP Shah Arts & Science College, Surendranagar, India  
ljubica.kazi@tfzr.rs, dragica.radosav@tfzr.rs, narendra\_chotaliya@yahoo.com

**Abstract** – In aim to enhance design and functionality of educational institutions web portals, it is essential to establish a framework for their evaluation. This paper contributes with proposing a particular framework that could be used in usability analysis and assessment of higher education institutions web portals. The initial verification of the framework applicability has been made with a case study conducted upon Serbian state-owned universities schools that have main focus on technical sciences, i.e. faculties of technical sciences in Serbia. Results of the case study show that the proposed framework could be applied to university schools in technical sciences, but also it is suitable for any other higher education institution web portal assessment. It could provide directions for further improvements and development in the area of higher education institutions web portals.

## I. INTRODUCTION

In the modern world, using Internet has become inevitable in all areas of human activities. Area of education is highly innovative and educational staff and students eagerly accept new technologies [1]. Some of positive results in using Internet in educational process have been reported in primary schools, with highly positive attitudes of teachers [2]. University became one of leading institutions to promote using Internet and educate in this area [3].

It is of a special interest to address using information and communication technologies in educational institutions that are particularly focused on technologies, such as technical vocational (secondary) schools and university schools of technical sciences [4]. It has been explored that the most influential factors to successful use of ICT in technical schools, at particular case of Turkish technical schools, were level of education of teaching staff, age and accessibility of computers [5]. The issue of IT literacy of teaching staff has been particularly emphasized, where specific aspects and

factors were addressed, such as attitude, infrastructure and technical support, training for of new technologies use and IT-dependent competencies development [6]. There are many efforts made in improvement of IT literacy and competences of teaching staff, particularly in technical vocational schools in Ukraine, where combined methods were implemented and they lead to positive impact to ICT knowledge and skills enhancements of teaching staff. These efforts, consequently, influenced improved professional competence of school graduates [4].

Internet technologies are used as tools for university level teaching and learning in many educational fields, such as language teaching [7]. In recent circumstances of pandemic and economic instability, the approach of blended instructional environment, with the combined use of web-based technologies and the personal attendance, enables greater flexibility and better accessibility to educational process for regular and adult students, often being employed [8]. Higher education institutions (HEI) web portals often support managerial and educational business processes and integrate appropriate data, enabling closer cooperation of all processes stakeholders (such as teaching staff, administrative staff and students), while keeping institutional self-governance [9].

Considering the importance of HEI web portals, it is of a great interest to have the quality solutions implemented and maintained, to keep them usable. In aim to develop adequate solution, or to improve existing HEI web portals, it is crucial to have the reference to adequate framework for their evaluation, particularly from usability aspect. Aim of this paper is to explore existing approaches to evaluation of

educational web portals usability, with particular emphasize on higher educational institutions related to technical sciences. This paper proposes a framework for usability evaluation of such web portals. Suitability of the framework is tested on Serbian university schools (faculties) that are focused on technical sciences.

## II. RELATED WORK

In the systematic literature review [10], mayor aspects of higher education institution web portals have been explored, such as: software used in web portals, internal and external benefits, acceptance of technology and management and storage of information. It has been concluded that there is a great shortage of scientific articles regarding HEI web portals.

Usability of educational web portals has been in multiple research focus. In [11], Nigerian undergraduate students' perception of the impact of web portal on e-learning has been surveyed, in aim to draw conclusions on challenges that students were faced during the web portal use and to provide suggestions for improvements of educational web portal. It has been concluded that using educational web portal (in this research it was web portal of a single university) enabled a supplementary way of information dissemination and sharing – organizational info and learning resources, but also enables collaboration, knowledge assessment, learning management and academic records. Challenges of using web portal were related to power supply, slow network, availability of access to internet from students' residence, constant availability of electronic materials (not to be removed), system administration of users (passwords, access).

The use of university web portals as a communication channel has been examined in a two-year study conducted in Australia, at a large university, i.e. business information technology school [12]. In this research, findings indicate that students use web portals occasionally in critical phases of study, "at the last minute" or "just in time", but they prefer personal contact and communication. They expect web portal to be highly personalized and to provide precise information regarding their particular circumstances and status.

In [13], usability evaluation of seven Lebanese universities has been explored among students and faculty members (teaching staff). One of aspects that were explored in questionnaire was average usage of services at web portal and they include: online

registration, online grades, exam schedules, course offering, course evaluation, online advising, electronic mail, course homepage, announcements, and electronic library. Most important difficulties that students face in using HEI web portals were elicited from questionnaires are: knowledge and skills how to use the service (not explained, not trained), problems with accessibility (no or slow internet connection, complex system – too many clicks). Other important aspects of this research include: graphical appearance, ease of use and organization, using web portal on a daily basis to perform tasks (success, errors, time to complete, user satisfaction), quality of data presented at web portal (validity, usefulness).

Perceived usefulness of the educational web portal has been extracted from research, conducted at University of East in Philippines, as one of the crucial factors of their acceptance and correlated to other behavioral similar factors [14]. Davis et al. defined the term "perceived usefulness as the degree to which a person believes that using a particular system would enhance his or her job performance." [14] [15]. Research [14] emphasizes behavioral factors that influence the perceived usefulness, such as external variables, perceived ease of use, attitude toward using the system, behavioral intention to use the system. Research [16] expanded Davis's Technology Acceptance Model [15] by adding three user-related external factors and conducted research with 429 students in aim to determine user acceptance criteria of university web portals. It has been shown that website quality, perceived self/efficacy and facilitating conditions were significant in explaining students' use of university web portals. Particular survey has been conducted at five UAE universities, in aim to determine students' perspective in quality evaluation of university web portals [17].

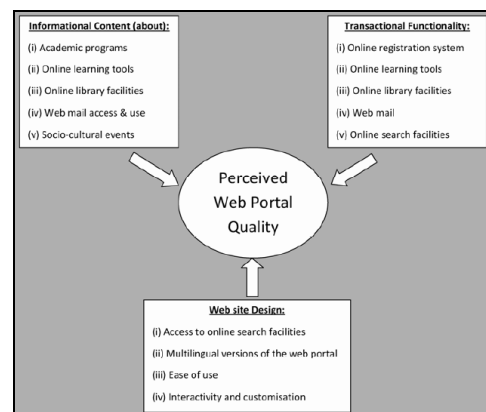

Figure 1. Factors that influence perceived web portal quality [17]

Research [17] contributes with an evaluation instrument – the University Portal Usability Assessment Index, which rates the quality of university portals in four areas: informational content, transactional content, website design, and students' satisfaction. Sometimes, there are a state level guidelines for creating educational web sites, such as those defined by the Commission for Academic Accreditation in UAE [17]. There are also international standards that provide directions for creating and improvement of web sites, such as ISO 9241-151:2008 - Ergonomics of human-system interaction — Part 151: Guidance on World Wide Web user interfaces. [18]

Using instruments and tools in evaluation of web portals is relevant in aim to enable their standardized and unbiased evaluation. In [19], Prometheus tool and data mining have been used for the purpose of analysis of usability of universities web portals. Prometheus tool implements the SIRIUS system, where relevant web sites usability issues are detected before they are put in production, i.e. using. Aspects that SIRIUS system particularly emphasizes are: general aspects, identity and information, structure and navigation, labeling, page layout, understandability and ease of interaction, control and feedback, multimedia elements, search and help.

The usefulness is tightly related to levels of sophistication of web services at a web portal [20] : 1) Information, 2) One-way communication, 3) Two-way communication, 4) Transaction and 5) Personalization. Personalization of web portals could be presented in broader context of user experience, presented with levels at figure 2. [21]

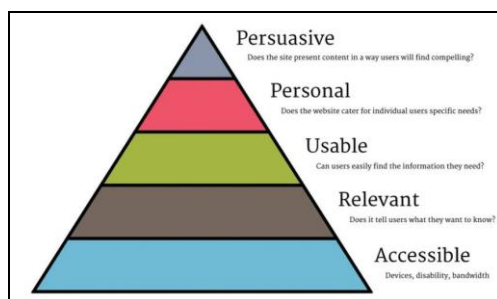

Figure 2. User experience and personalization [21]

Recent professional solutions provide automation in evaluation of user experience in using web applications. Some of most popular tools are SmartLook [22], Horjar [23] and others, listed at [24] and [25]. Most of them are based on monitoring

of users' behaviour while using web sites, i.e. underlying web applications. Monitoring with these tools are mostly based on recording about particular types of user behaviour and sometimes requires instrumentation of existing solution, with adding program code (in Java Script, for example) which will enable the monitoring process. Most of these professional solutions are general monitoring tools, while some of them have features that enable semantic specialization in evaluation, regarding particular industry (i.e. using area) which the monitored web site is made for.

### III. THE PROPOSED FRAMEWORK FOR USABILITY EVALUATION OF HEI WEB PORTALS

#### A. Research Problem Statement

Having concerned previously mentioned, it is obvious that, regarding usability evaluation of HEI web portals, there is lack in developed instruments, i.e. models for evaluation, presented in scientific literature, i.e. related work. However, in professional environment, there are many software tools recently developed, that have the main focus on automating the process of web sites user experience and satisfaction monitoring (mostly without any focus on particular semantic, i.e. application area of web site use). Monitoring is based on data acquisition and analysis, for the purpose of decision making aid in web applications improvements and development. These tools require users to actually use the product to be monitored, in aim to get relevant information and user behavior insight, while some solutions require instrumentation (adding auxiliary code that enables monitoring) in existing web site solutions.

Obviously, there is a gap between research results and professionally developed tools. Generally speaking, research provides insufficiently precise instruments, while automation, enabled in professional environment, is generally set to any web sites, requires code instrumentation and users to be involved in monitoring process.

It is necessary to determine set of criteria that:

- Could be used for evaluation of usability of particular type of web portals - HEI web portals, and if possible, even more precise – web portals of University schools of Technical Sciences.
- These criteria are defined regardless automation, i.e. it is not important if the criteria could be measured automatically or manually,
- These criteria are defined to be used without involving actual users to utilize web portal, i.e. perform activities upon HEI web portal functionality.
- Framework for evaluation of HEI web portal should include all stakeholders, i.e. potential users of the portal, not only students (emphasized in [17]).

- The proposed framework should enhance existing proposals for HEI web portal evaluation .

**B. The Proposed Evaluation Framework**

In this paper, main aim is to propose a framework for evaluation of HEI web portals, with special focus on University Schools of Technical Sciences web portals. The proposed framework is transformed and extended from [17], [20] and [21].

**TABLE I. THE PROPOSED FRAMEWORK FOR USABILITY EVALUATION OF WEB PORTALS OF UNIVERSITY SCHOOLS OF TECHNICAL SCIENCES**

<b>Usability Evaluation Framework for University Schools of Technical Sciences</b>	
<b>Information Content</b>	<b>Transaction Content</b>
Data accuracy	News
Data form – text, multimedia	Business process support:
Menu and navigation	- Education – curriculum, study programme description, admission, e-learning, e-library, exams, graduation, mobility, alumni, continuing education
Search	- Science – conferences, journals, publications, research groups
Site Map	- Projects
	- Technical solutions and patents
	- Cooperation with industry
	Managerial support:
	- Documents – Forms and legislation
	- Organization units and staff
	- Resources (laboratories, software and equipment)
	- Quality assurance, accreditation
	- Public procurements
	- Contact
<b>User Experience Design</b>	<b>Stakeholders</b>
Graphical design – harmonized (all elements and segments are similar)	Personalization – possible users login and personalized content – for students, for employees
Responsiveness – adjustability to different devices	Separate content for different categories of users
	Languages support, harmonized language in content

The proposed framework emphasizes the web portal content (Information and stakeholders’ aspect), functionality (Transaction aspect) and graphical aspect. Specific aspect of schools of technical sciences is that they have specific activities related to technical solutions, patents and collaboration with industry.

**IV. EMPIRICAL RESEARCH**

**A. Research Methodology and Sample**

In this research, the proposed framework will be applied to the sample of public (state-owned) university schools of technical sciences in Serbia. Sample includes only faculties whose name is related to technical sciences or electrical engineering. Therefore, the proposed

evaluation framework will be applied to HEI web portals with previously explained characteristics and it will be six web portals included. The analysis will be performed only upon English versions of their web portals and only with English content at web portal pages. For each characteristics from the proposed framework there will be

**TABLE II. PUBLIC UNIVERSITY SCHOOLS OF TECHNICAL SCIENCES IN SERBIA**

<b>Public University School of Technical Sciences</b>	<b>Web portal URL</b>
University of Belgrade School of Electrical Engineering	<a href="https://www.etf.bg.ac.rs/">https://www.etf.bg.ac.rs/</a>
Unievrsity of Novi Sad, Faculty of Technical Sciences	<a href="http://ftn.uns.ac.rs/">http://ftn.uns.ac.rs/</a>
University of Nis Faculty of Electronic Engineering	<a href="https://www.elfak.ni.ac.rs/en/">https://www.elfak.ni.ac.rs/en/</a>
University of Kragujevac Faculty of Technical Sciences Cacak	<a href="http://www.ftn.kg.ac.rs/">http://www.ftn.kg.ac.rs/</a>
State university of Novi Pazar Department for Technical Sciences	<a href="http://www.dunp.np.ac.rs/tehnickenauke/">http://www.dunp.np.ac.rs/tehnickenauke/</a>
University of Pristina (temporary in Kosovska Mitrovica) Faculty of Technical Sciences	<a href="http://ftnkm.srb">ftnkm.srb</a>

given 0 or 1 point, considering existence of the examined feature (content or quality).

Web pages of previously mentioned web portals will be presented in next figures.

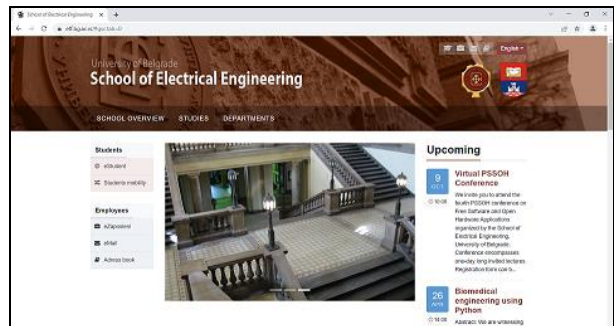

**Figure 3. Web portal - School for Electrical Engineering, University of Belgrade, Serbia**

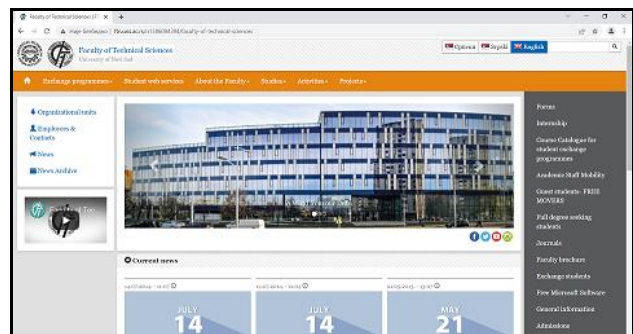

**Figure 4. Web portal – Faculty of Technical Sciences, University of Novi Sad, Serbia**

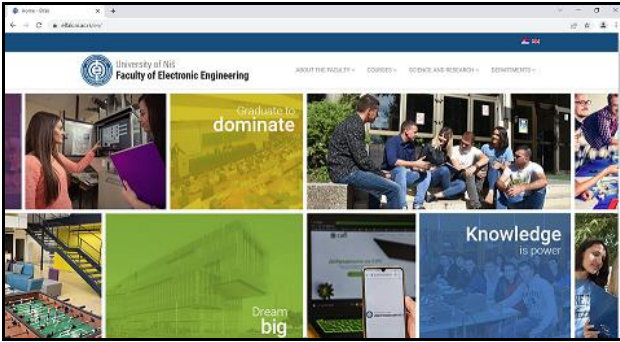

Figure 5. Web portal – Faculty of Electronic Engineering, University of Nis, Serbia



Figure 6. Web portal – Faculty of Technical Sciences Cacak, University of Kragujevac

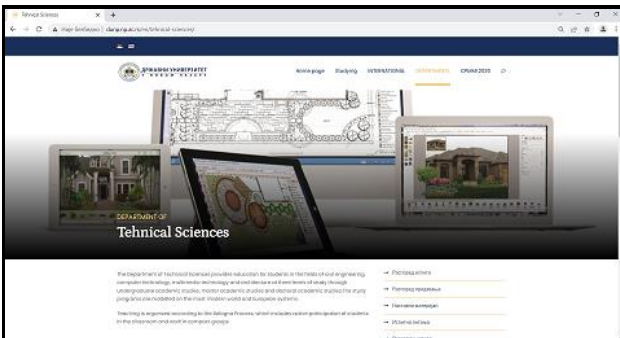

Figure 7. Department of Technical Sciences, State University in Novi Pazar

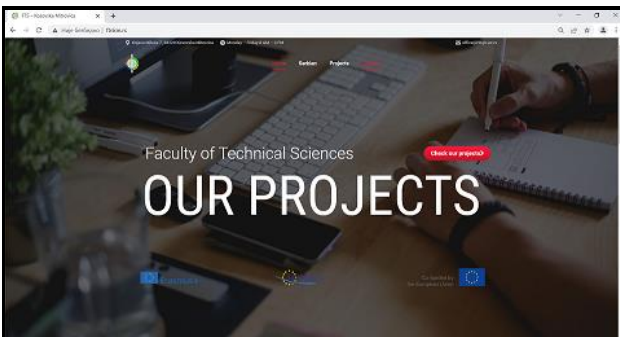

Figure 8. Faculty of Technical Sciences, University of Pristina (temporary in Kosovska Mitrovica)

**B. Results**

In this section, results of evaluation of six HEI web portals will be presented. Table III presents points given to

each of feature for evaluation, that is included in the proposed framework.

TABLE III. RESULTS OF HEI WEB PORTALS EVALUATION FOR UNIVERSITY SCHOOLS OF TECHNICAL SCIENCES IN SERBIA

Unive rsity	Text	Multime dia	Accuracy	Menu navigation	Search	Site map	News											
BG	1	1	0	1	0	0	1											
NS	1	1	0	1	1	1	1											
NI	1	1	N/A	0	1	0	0											
KG	1	1	1	1	1	1	0											
NP	1	1	0	1	1	1	0											
PR	1	1	N/A	0	0	0	0											
Unive rsity	Curri culu m	Study program descriptio n	Admissio n	E-learning	E-library	Exams	Graduatio n	Mobility	Alumni	Continui ng education								
BG	1	1	1	0	0	0	0	1	1	0								
NS	1	0	1	0	0	0	0	1	0	0								
NI	1	1	0	0	0	0	0	0	0	1								
KG	1	0	0	0	0	0	0	1	0	0								
NP	0	1	1	0	0	0	0	1	1	0								
PR	0	0	0	0	0	0	0	1	0	0								
Unive rsity	Conf erences	Journals	Publicatio ns	Projects	Research groups	Technical solutions	Patents	Cooperati on with Industry										
BG	0	0	0	0	0	0	0	0										
NS	1	1	0	1	0	0	0	1										
NI	0	0	0	1	1	0	0	0										
KG	1	1	0	1	0	0	0	0										
NP	0	0	0	0	0	0	0	0										
PR	0	0	0	0	1	0	0	0										
Unive rsity	Form s	Legislatio n	Organizat ion units	Staff	Resource s (software / equipme nt)	Quality assuranc e, accredita tion	Public procurem ents	Contact										
BG	0	0	1	1	0	0	0	1										
NS	1	0	1	1	1	1	0	1										
NI	0	0	1	0	0	0	0	1										
KG	0	0	1	1	1	0	0	1										
NP	0	0	1	0	1	1	1	1										
PR	0	0	0	0	0	0	0	1										
Unive rsity	Har monized graphical desig n	Responsi ve to different devices	Students User login and personaliza tion	Employees User login and personaliza tion	Categorie s of users content separatio n	Language s support	Harmoni zed language in content											
BG	1	1	1	1	1	1	1											
NS	1	1	0	0	0	0	1											
NI	1	1	0	0	0	0	1											
KG	1	1	0	0	0	1	0											
NP	0	1	0	0	0	1	0											
PR	0	0	0	0	0	1	1											

According to previously presented results, it has been shown that University of Novi Sad School of Technical Sciences received the highest points and evaluation percentage of 57,50%.

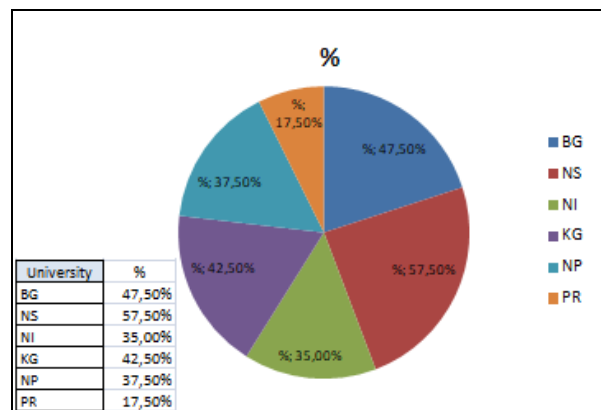

Figure 9. The results of evaluation of HEI web portals for University Schools of Technical Sciences in Serbia, with application of the proposed framework

## V. CONCLUSION

Higher education institutions web portals become one of the most essential communication channels and the tool for integration of data in coordination of activities of all stakeholders in business processes. There are several business process groups in HEI, which are to be supported by HEI web portals – managerial, educational, research and cooperation with industry. Each of these business process segments have their particular set of data, functionality and users of HEI web portal. This way, HEI web portal becomes a tool to establish an integrated information system of a HEI.

Aim of this paper was to systematize existing research results related to usability evaluation of HEI web portals, but also to elaborate more precise state-of-art related to evaluation of web portals of university schools (faculties) of technical sciences. It has been shown that there is a lack of research related to HEI web portals evaluation generally and that there are not much related work in research papers done in particular area of technically-oriented schools (mostly there are papers published regarding vocational secondary schools use of ICT).

This paper contributes with a framework for usability evaluation of web portals of university schools that are oriented towards technical sciences. The proposed usability framework includes aspects such as information content, transaction content, user experience design and stakeholders. These aspects are groups of features to be examined and evaluated. Together with the set of features, the methodology of evaluation includes determining existence of each of the mentioned feature and giving points for each of them (0 or 1). By calculating the sum of all points there could be a summary score for each HEI web portal. In this paper, the proposed framework's applicability has been proven by application upon six HEI web portals in Serbia, with six schools of technical sciences at six different universities in Serbia. This way, framework was presented as usable, since it provides measurable results.

Future research in this field could be directed towards creating a broader framework for evaluation of different aspects of HEI quality, not only usability. Other research directions could be towards automation – to explore what features could be evaluated automatically and which of them have already been supported by existing professional software tools for usability evaluation.

## REFERENCES

- [1] C. Redecker, "Review of Learning 2.0 Practices: Study on the Impact of Web 2.0 Innovations on Education and Training in Europe", JRC Scientific and Technical Reports, European Commission, Joint Research Centre, Institute for Prospective Technological Studies, ISSN 1018-5593, European Communities, 2009.
- [2] L. Stosic, I. Stosic, "Perceptions of Teachers Regarding the Implementation of the internet in education", *Computers in Human behavior*, vol. 53, pp. 462-468, 2015.
- [3] A. Goldfarb, "The (Teaching) Role of Universities in the Diffusion of the Internet", Rotman School of Management, University of Toronto, Canada, May 2004.
- [4] A. Lytvyn, V. Lytvyn, L. Rudenko, Y. Pelekh, O. Didenko, R. Muszkieta, W. Zukov, "Informatization of Technical Vocational Schools: Theoretical Foundations and Practical Approaches", *Education and Information Technologies*, 25, pp. 583-609, 2020.
- [5] F. K. Mumcu, Y. K. Usluel, "ICT in Vocational and Technical Schools: Teachers Instructional, Managerial and Personal Use Matters", *TOJET: The Turkish Online Journal of Educational Technology*, volume 9, Issue 1, January 2010.
- [6] N. A. Razak, M. A. Embi, R. B. Mustapha, M.A. Lubis, "IT Literacy of Language Teachers in Malaysian Technical Schools", *Proceedings of the 5th WSEAS/IASME International Conference on Educational Technologies (EDUTE'09)*, pp. 143-150, 2009.
- [7] S. Celik, "Internet-assisted Technologies for English Language Teaching in Turkish Universities", *Computer Assisted Language Learning*, Vol 26, No 5, pp. 468-483, 2013.
- [8] L. Lloyd-Smith, "Exploring the Advantages of Blended Instruction at Community Colleges and Technical Schools", *MERLOT Journal of Online Learning and Teaching*, Vol 6, No. 2, June 2010.
- [9] R. N. Katz, R. I. Gross, "Web Portals and Higher Education, Technologies to make IT Personal", in: *The Policy Challenges*, Chapter 10, Jossey-Bass Inc, 2002.
- [10] C. Pinho, M. Franco, L. Mendes, "Web Portals as Tools to Support Information Management in Higher Education Institutions: A Systematic Literature Review", *International Journal of Information Management*, Vol. 41, pp. 80-92, August 2018.
- [11] A. Tella, M.T. Bashorun, E.O. Adu, "Impact of Web Portals on E-Learning", *ARPN Journal of Science and Technology*, VOL. 2, NO. 8, pp. 717-724, ISSN 2225-7217, Sep 2012.
- [12] A. Lukaitis, B. Davey, "University Web Portals - Patterns and Policies", in *IFIP International Federation for Information Processing, Volume 292; Evolution of Information Technology in Educational Management*; Eds. Tatnall, A., Visscher, A., Finegan, A., O'Mahony, C., (Boston: Springer), pp. 23-30, 2009.
- [13] L. A. Daher, I. Elkabani, "Usability Evaluation of Some Lebanese Universities Web Portals", *The 13th International Arab Conference on Information Technology ACIT'2012*, Dec.10-13, 2012.
- [14] M.N. Tolentino, "University Web Portals as Information Management Tool: Technology Acceptance Dimension", *International Journal of Management & Information Systems*, Volume 15, Number 3, Third Quarter 2011.
- [15] F. D.Davis, R.Bagozzi, P. R. Warshaw, "User acceptance of computer technology: A comparison of two theoretical models", *Management Science*, 35, 982-1003, 1989.
- [16] N. Fathema, M. Ross, M. M. Witte, "Student Acceptance of University Web Portals:", *International Journal of Web Portals (IJWP)*, 2014.
- [17] M.N.A. Abdelhakim, J.N. Carmichael, S. S. Ahmad, "Quality Evaluation of University Web Portals: a Student Perspective", *Int. J. Information and Operations Management Education*, Vol. 4, Nos. 3/4, pp. 229-243, 2011.
- [18] ISO 9241-151:2008 - Ergonomics of human-system interaction — Part 151: Guidance on World Wide Web user interfaces, <https://www.iso.org/standard/37031.html> [accessed: June 1, 2021]
- [19] L. Chamba-Eras, L. Jacome-Galarza, R. Guaman-Quinche, E. Coronel-Romero, M. Labanda-Jaramillo, "Analysis of Usability of Universities Web Portals Using the Prometheus Tool - SIRIUS", *IEEE Fourth International Conference on eDemocracy & eGovernment (ICEDEG)*, 2017.
- [20] Guidelines for development of e-Government web presentations v.5.0 (In Serbian: Smernice za izradu veb prezentacija organa državne uprave), Republika Srbija, Ministarstvo državne uprave I lokalne samuprave, direkcija za elektronsku upravu, [http://arhiva.ite.gov.rs/doc/Smernice\\_5\\_0.pdf](http://arhiva.ite.gov.rs/doc/Smernice_5_0.pdf) [accessed: June 1, 2021]
- [21] User Experience and personalization at web sites, <https://boagworld.com/digital-strategy/website-personalization/> [accessed: June 1, 2021]
- [22] Usability testing tool SmartLook, [www.smartlook.com](http://www.smartlook.com), [accessed 1 June 2021]
- [23] Usability testing tool HotJar, <https://www.hotjar.com/>, [accessed 1 June 2021]
- [24] List of most popular user testing tools, <https://maze.co/guides/usability-testing/tools/> [accessed 1 June 2021]
- [25] Usability testing and 12 most popular usability testing tools, <https://www.softwaretestinghelp.com/best-usability-testing-tools/>



# Example of an Application in the Python Programming Language

S. Mrđen\*, E. Brtka\*, V. Makitan\*, M. Sisak\*\*

\* University of Novi Sad/Technical Faculty “Mihajlo Pupin”, Zrenjanin, Republic of Serbia

\*\* West Regional Development Agency, Timisoara, Romania

mrdjen.simo@gmail.com, eleonorabrtka@gmail.com, vesna@tfzr.uns.ac.rs, mirasisak26@gmail.com

**Abstract** - The paper shows the possibilities of the Python programming language on the example of a simple application. The application successfully combines two main concepts: procedural approach and object-oriented approach to software development. In Python this is possible, unlike most other programming languages, so it is very convenient for learning object-oriented programming for someone who is already familiar with the procedural style of programming.

## I. INTRODUCTION

Python is a general-purpose and a high-level language, meaning that Python code is easy-to-read and understand. Python is beginner-friendly and aims to imitate the regular English language [1]. The opinion of the authors and it seems that a large part of the community dealing with this issue is that Python is a very good choice as a language to start learning an object-oriented paradigm [2].

The Black Jack application was created as a project during the Python programming language training.

By the way, this is a simulation of a card game, which has simple rules and is very popular. The game is played with 52 cards, and the game takes place between the player and the dealer, which is actually a casino. Each card has its own face value, the card number is in fact its face value, while all pictures are worth 10 and the ace is worth 11, or only 1 if it suits the player better. The winner is the one who has a larger sum in his hands, with the largest possible sum being 21, whoever exceeds this limit automatically loses the game.

At the beginning of the game, the dealer deals two cards, to himself and to the player. A player can request an additional card from the dealer if he deems it necessary, and so on for as long as he wishes. If his sum exceeds 21, he loses the game, and if he draws an ace, and his sum is greater than 21, then the ace is calculated 1.

When a player does not want more cards, the dealer withdraws the cards until the total in his hand is less than 17.

The winner is the one who has a higher sum, and did not exceed 21 [3].

## II. APPLICATION BLACK JACK

The application could be implemented in many ways, but the goal was to use classes and methods as much as possible.

When we start with the realization, we first need to instantiate the values of the possible colors of the maps. The four colors are placed in the suit list (Fig. 1), as well as to include a random library[4], whose functions we will need later (Fig. 1).

```
import random

suits = ('Hearts', 'Diamonds',
        'Spades', 'Clubs')
```

Figure 1. Creating of list of suits and importing random functions

The next step is to create a list of ranks with card strengths, which we will create as a list of strings as they are called in the game (Fig. 2).

```
ranks = ('Two', 'Three', 'Four',
        'Five', 'Six', 'Seven', 'Eight',
        'Nine', 'Ten', 'Jack', 'Queen',
        'King', 'Ace')
```

Figure 2. Creating a list of ranks.

We instantiate dictionary values (Fig. 3) with key: value pairs, which we will need to assign a numeric value to the string values of certain maps. This will be the value in the key: value pair. We need a string representation of the rank of the map because of the printout in the console, and the numerical value because of the calculations in the program itself.

```
values = {'Two':2, 'Three':3,  
         'Four':4, 'Five':5, 'Six':6,  
         'Seven':7, 'Eight':8, 'Nine':9,  
         'Ten':10, 'Jack':10,  
         'Queen':10, 'King':10, 'Ace':11}
```

Figure 3. Creating a dictionary values.

We also need one object with a boolean value, and we initialize with a value of True (Fig.4).

```
play_turn = True
```

Figure 4. Variable play\_turn

We need to create a Card class (Fig. 5), which will be a representation of an individual card. From the attributes the card will have the rank and suit attributes. Of the methods, only the `__str__` method will have the task of providing us with a string representation of objects of this class, due to printing in the console.

```
class Card:  
    def __init__(self,rank,suit,val):  
        self.rank = rank  
        self.suit = suit  
        self.card = (rank,suit)  
        self.value = val[self.rank]  
    def __str__(self):  
        return self.rank + ' of ' + self.suit
```

Figure 5. Class Card

We test whether a class is created correctly, we instantiate one object of that class and print it in the console (Fig. 6).

```
card_probe = Card("Two","Hearts")  
print(card_probe)  
  
>>Two of Hearts
```

Figure 6. Instanting one object of class Card and output

Next, we create a Deck class that will be a representation of 52 Card class objects (Fig. 7). Class Deck includes methods for splitting cards from deck - deal, method for shuffling cards - shuffle, as well as string representation of deck.

```
class Deck:  
    def __init__(self,ranks,suits,val):  
        self.deck = []  
        for r in ranks:  
            for s in suits:  
                self.deck.append(Card(r,s,val))  
  
    def deal(self):  
        return self.deck.pop()  
  
    def __str__(self):  
        s = 'Your deck is:\n'
```

```
        for card in self.deck:  
            s += card.__str__()+'\n'  
        return s  
  
    def shuffle(self):  
        random.shuffle(self.deck)
```

Figure 7. Class Deck

We will instance an object of Card class, and using shuffle method will mix cards, and at the end, we will print whole deck because of checking (Fig. 8).

```
deck_probe = Deck( ranks,suits,values)  
deck_probe.shuffle()  
print(deck_probe)  
  
King of Hearts  
Jack of Spades  
Ten of Diamonds  
Two of Diamonds  
Four of Hearts  
Two of Hearts  
Three of Spades  
Ace of Spades  
Eight of Hearts  
Queen of Spades  
Five of Spades...
```

Figure 8. Instanting an object of Deck class

When players participate in the game, each of them has a certain number of cards in their hands. We will abstract this through the Hand class (Fig. 9). This class will have a result attribute that represents the value of the cards, as well as a list of cards held by the player. The class method will have a `take_card` method that will allow the player to take a new card from the class Deck object, which also adjusts the value of the result variable depending on the drawn card.

```
class Hand:  
    def __init__(self):  
        self.hand = []  
        self.hand_value = 0  
  
    def take_card(self,deck):  
        deal = deck.deal()  
        self.hand.append(deal)  
  
        self.hand_value += deal.value  
        if deal.rank == \  
            'Aces' and self.hand_value > 21:  
            self.hand_value -= 10  
  
    def __str__(self):  
        s = 'Your cards are :\n'  
        for card in self.hand:  
            s += card.__str__()+'\n'  
        return s+'Value in your hand is :\n'  
            '{}'.format(self.hand_value)  
  
    def ask_for_more(self):  
        global play_turn  
        while True:
```

```
try:
    ans = \
        input('Would you like to \
            take another card y/n')
except:
    print('Try again')
    continue
else:
    if ans == 'y':
        self.take_card(deck)
        print(self.__str__()+'\n')
        if self.hand_value > 21:
            play_turn = False
            break
        elif ans == 'n':
            print(self.__str__()+\
                '\nDealer turn!')
            play_turn = False
            break
        else:
            print('Wrong answer.\
                Try again!')
            break
```

Figure 9. Class Hand

In the PlayerAccount class (Fig. 10) we place other necessary methods for playing the game: take\_bet, lose\_bet and win\_bet.

```
class PlayerAccount:
    def __init__(self, deposit=100):
        self.total = deposit
        self.chip = 0

    def take_bet(self):

        while True:
            try:
                self.chip = int(input(\
                    'Enter amount of chip!'))
            except:
                print('Value must\
                    be number!!')
                continue
            if self.chip > self.total:
                print('Try again. Chip\
                    must be lower then your total!')
                continue
            else:
                print('Your chip\
                    is ',self.chip, ' $')
                break

    def win_bet(self):
        self.total += self.chip

    def lose_bet(self):
        self.total -= self.chip

    def __str__(self):
        return 'Your total is {} $\
            !'.format(self.total)
```

Figure 10. Class PlayerAccount

We need another function that we created outside the class (Fig. 11), which will print dealers cards for us.

```
def dealer_start(hand):
    print('Dealer start is: '\
        + hand.hand[1].__str__())
```

Figure 11. Function dealer\_start

#### A. Playing game

The beginning of the game simulation, ie the realization of the game logic (Fig. 12). The logic presented in this part of the code is explained in the introductory part of the paper.

```
#START GAME

print('Welcome to game BLACK JACK!!!')

#Creating players account with amount of 200$
player_account = PlayerAccount(deposit= 2000)

continue_game = True

while continue_game:

    #Creating new deck of cards and mix them
    deck = Deck(ranks,suits,values)
    deck.shuffle()

    #Creating hand for player and dealer
    player = Hand()
    dealer = Hand()

    player.take_card(deck)
    player.take_card(deck)

    dealer.take_card(deck)
    dealer.take_card(deck)

    dealer_start(dealer)
    print('')
    print(player,'\n')

    player_account.take_bet()

    play_turn = True
    while play_turn:
        player.ask_for_more()

        if player.hand_value > 21:
            player_account.lose_bet()
            print('You lose!')
            print(player_account,'\n')
            play_turn = False
            break

        while not play_turn and \
            player.hand_value < 22:
            if dealer.hand_value <17 :
                dealer.take_card(deck)
                print('Dealer hand is '\
                    ,dealer.hand_value,'\n')
                continue
            elif dealer.hand_value > \
                player.hand_value and \
                dealer.hand value < 22:
```

```

        player_account.lose_bet()
        print('Dealer win!!!')
        print(player_account)
        break
    elif dealer.hand_value > 21\
        or dealer.hand_value \
            < player.hand_value + 1:
        player_account.win_bet()
        print('Dealer lost! Player win!')
        print(player_account)
        break
while True:
    try:
        n = input('Do you like to \
            continue game y/n ?')
    except:
        print('Must enter <y> or <n> !\
            Try again!')
        continue
    else:
        if n == 'y':
            print("Begin a new \
                game!!! \n")
            break
        elif n == 'n':
            print("End game!")
            print(player_account)
            continue_game = False
            break
        else:
            print('Must enter <y> or \
                <n> ! Try again!')

```

Figure 12. Logic of BlackJack game

The whole program was written and tested, now we can give an example[5] of how the application works (Fig. 13).

```

You have amount of 200 $

Player scor and cards: Your score is 21
Your cards are:
Jack of Spades
Ace of Hearts

Dealer scor and cards: Your score is 15
Your cards are:
Four of Diamonds
Ace of Spades

Enter amount of bet 

```

Figure 13. Example of gaming BlackJack

Once we have finally entered the correct amount, we are asked if we want another ticket or not (Fig. 14).

```

If you want take another card enter <y>, or <n> if dont!

```

Figure 14. Asking for one card more

This is what one cycle of the game would look like (Fig. 15):

```

You have amount of 200 $

Player scor and cards: Your score is 21
Your cards are:
Jack of Spades
Ace of Hearts

Dealer scor and cards: Your score is 15
Your cards are:
Four of Diamonds
Ace of Spades

Enter amount of bet Simo
Must enter number
Enter amount of bet 201
Amount of bet must be lower then your total amount
Enter amount of bet 50
If you want take another card enter <y>, or <n> if dont!
n
Dealer turn!

Your score is 21
Your cards are:
Jack of Spades
Ace of Hearts

Dealer: 25

Dealer has lose!

You have amount of 250 $

If you want to play new game enter <y>, or <n> if you dont!

```

Figure 15. One cycle of the game

### III. CONCLUSION

The application can be improved by improving the interface. It would be interesting to add a graphical interface, which would display pictures of the cards that the player has in his hands. Also, some graphic effect could be added when winning or losing the game, which would add a little excitement to the game, this way it is quite monotonous. However, the goal of this project was an example of working with classes and objects, as well as the presentation of working with this object-oriented programming language, so that the goal was fully achieved.

### ACKNOWLEDGMENT

This research is financially supported by Ministry of Education and Science of the Republic of Serbia under the project number TR32044 "The development of software tools for business process analysis and improvement", 2011-2021.

### REFERENCES

- [1] Allen B. Downey, Jeffrey Elkner, Peter Wentworth, and Chris Meyers, "How to Think Like a Computer Scientist: Learning with Python 3", Green Tea Press (January 4, 2002); ReadTheDocs.org (eBook, Feb 26, 2019)
- [2] Bill Lubanovic, "Uvod u Python - Moderno računarstvo u jednostavnim paketima", O' Reiley 2015, CET 2015
- [3] <https://www.udemy.com/course/complete-python-bootcamp>
- [4] <https://www.python.org/>
- [5] <https://www.udemy.com/course/python-and-django-full-stack-web-developer-bootcamp/>

# Application of 3D Printing in Education

M. Živić\*, M. Pardanjac\*, J. Barbarić\*\*

\*University of Novi Sad, Technical faculty „Mihajlo Pupin“, Zrenjanin, Republic of Serbia

\*\*University of Colorado, Denver, Colorado, USA

marko.zivic@tfzr.rs

**Abstract** – Focal aim of this work is to explain the principles and areas of application of 3D printers in education. This way of printing is quite new tool in education at all levels. It was initially ment to be as an additional tool for prototyping in producing machine parts. Advantages in 3D printers usage are recognized in many areas of life and work, from toy making to building absolutely functional infrastructural erections. Wast variety of 3D printers uses in so many professions and leisure time activities made their way to educational settings. They significantly contribute in educational process indicating quality difference in it. The sole concept of 3D printing in education will be thoroughly elaborated in particular segments of this work, as its purpose, challenges and possible solutions in specific situations.

## I. INTRODUCTION

Modern educational process include variety of high-tech tools. Alongside electronic and IT tools, three dimensional models still help in real-world understanding. Visualizing helps perception of curriculum topics. Since 3D printers can build numerous variety of shapes, they can produce models for majority of curriculum units. Student will be able to design and produce models applicable for different school subjects at low cost. Practical classes of Art will enable creative freedom in designing unique statues or decorative artifacts which could be sold through entrepreneur school stalls for different occasions. The money which would be earned furthermore would be used for buying supplys for the next cycle. Students' involvement in 3D printing extracurricular activities would maximize student learning outcomes. Through the process of designing the object, just as through the process of fabricating them, students will be in a position to see and understand the object they are producing. Some of the students will acquire by making the specific objects, while the others will much easier understand the phenomena by seeing it in the three dimensional form. Therefore, 3D printers are more than just a common teaching aid.

## II. TECHNOLOGY OF 3D PRINTING

Nagoya Municipal Industrial Research Institute published detailed file on “rapid prototyping” technique in 1981. Dr Hideo Kodama explained

layer-by-layer 3D printing which were added on top of each previously laid one to form a 3D object. UV light was used to harden the material made from photopolymers. [1]

Stereolithography, SLA, is officially the first 3D printing where ultraviolet light was used to cure photopolymers. It was filed as a patent as digital slicing by three French engineers named Alain Le Méhauté, Olivier de Witte, and Jean Claude André in 1984 anticipated to revolutionize manufacturing. They could not see the business perceptiveness of this quite expensive project, hence, they abandoned it. However, Charles Hull obtained his STL format and digital slicing patent in 1986. He officially formed 3D Systems and presented the first 3D printer in 1987.

SLS, Selective Laser Sintering 3D printing is additive manufacturing (AM) process which belongs to powder bed fusion family. Thermoplastic polymers in granular form are treated by laser beam to be sintered into a solid structure formed

### A. SLS 3D Printing

Polymer powder is dispersed on a platform in a build chamber in a thin layer; laser beam scans the layer and hits it to heat it to the melting temperature and fuses its particles. It repeats the same procedure as many times needed until it builds the 3D object. It is then moved out of the build chamber while the rest of the powder is reused.

### How SLS 3D Printing Works

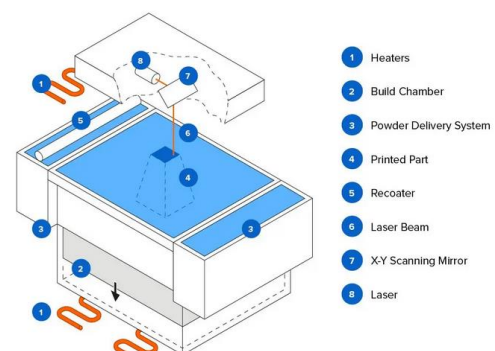

Figure1. SLS 3D printing machinery concept

### B. FDM

Fused deposition modeling (FDM) is a process in which thermoplastic filament from a spool is loaded into the extrusion head. It melts in the nozzle. The extrusion head moves in three dimensional area and extrudes the melted filament in layer-by-layer predetermined locations. When the process is finished, the object needs cooling and time to solidify. This technique is quite cheap and is the matter of the further elaboration in their work.

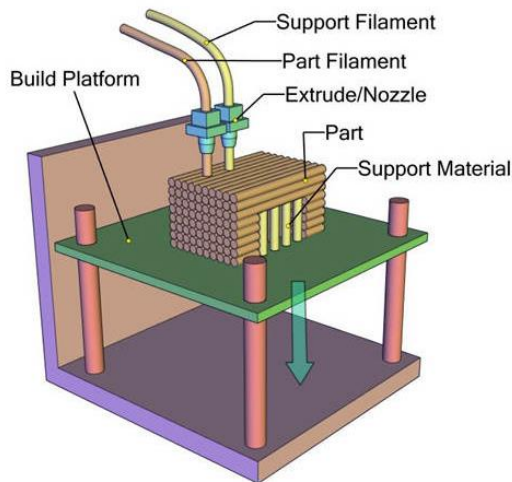

Figure 2. FDM machinery concept

### III. 3D printers practical use in educational process

Educators meet shortages in educational aids and equipment, therefore, affordable 3D printers which are used to manufacture them can aid students understand the topics and phenomena studied on lectures with much less effort if they have seen them in 3 dimensions, especially if they have helped in manufacturing them [2]. Hence, school, lecturers and students will benefit from 3D printers practical use [3].

For the sole beginning, the students will have to learn CAD software; they will also develop skills for designing models; then, on practical classes, they will fabricate their own designs; through the following discussions, they will elaborate possible adjustments which should be made; Practical usage of the objects which were made.

IT teachers in Serbia teach children in elementary schools from the fifth to the eight year teaching children from the age of eleven to the age of fourteen.

Young learners, at the age of eleven for example, usually have problems with understanding

mathematics notions and their specifics. Difference in cone and pyramid cubage with same base is much more acquirable when seen in an experiment made by pouring water from one to the other transparent hollow model, especially if they were involved in the fabrication of the models. The first outcome of learning through the process of geometric bodies production is to learn which model refers to which name. The second outcome will be understanding when seeing the mentioned difference in cubage. It is important to mention that young learners might have difficulties in comprehending abstract notions. They learn much easier when they see the actual three dimensional experiment depicting the phenomena in question.

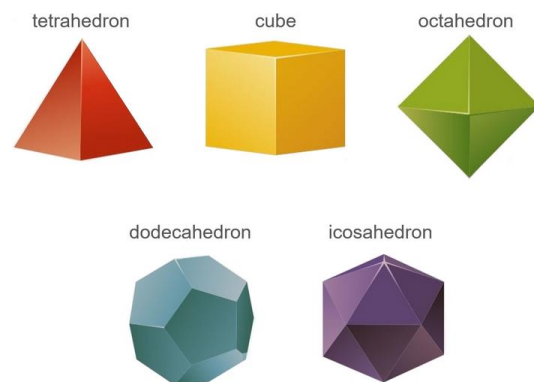

Figure 3. Mathematics object shapes

At the same year, the fifth, they learn about volcanos on geography classes. Majority of children, especially those from lowland areas, due to Covid pandemic, have never seen mountains, therefore neither volcanos. For some of them it could be vague to comprehend how they look like, the former, and how they function, the latter. It could be good idea to get her some students to do the research about the possible site which could be made on extracurricular classes where they would design the model after the discussion with other students and Geography and IT teachers, and finally make a 3D model which could be seen as a mountain from on side, and as a vertical cut of a volcano on the other side. They could possibly make a model of a complete volcano which could be used to make a lava out coming burst using dishwashing detergent, baking soda and red food color which should be put into the volcano. At the moment when the experiment would be held, teacher would pour vinegar which would induce aggressive chemical reaction and the red foam would start coming out of the volcano with quite a speed and come down the slopes of the volcano.



Figure 4. 3D replica of volcano

Chemistry teachers would be glad to have models of atom structure, crystal structure, molecule shapes and compound structures for example.

Technical education classes could be used for designing and fabricating different models. One year, they could build a City Hall, and it could be a nice gift for school guests when they come to our school on a volleyball tournament, for example; the next year, they could build our city coat of arms; those students who would like to become architects could fabricate the model of our town bridge and make appendance for keychains which would be given to all students, teachers and school guests. Things made this way could be sold on students' markets to other citizens to collect money for the supplies for the next production. This production can refund itself. That teaches students that their work make difference to their school that is confidence building for self in secure students. Students involved in 3D printing extracurricular activities will earn about entrepreneurship and its rules about demand, offer and refunding invested money into the process of production.

Many students find difficult to understand physics phenomena such as magnetic fields which can be made by 3D printers to exhibit how they work. The problem lies in the fact that those phenomena are not tangible or observed by human senses. One simple model of a simple direct current electric motor can demonstrate magnetic field phenomenon.

Students can fabricate small wind turbines which will demonstrate how wind power can be used for producing electrical energy and might be used in their classrooms to recharge mobile phones. Students would, therefore, learn about: renewable energy sources, ecology lesson, and the practical machine construction, technology education lesson.

Once they have made something like that by themselves and benefit as soon as it is made and positioned on the outer side of their classroom window, students will be encouraged to design and fabricate whatever they might need if it is printable, od course.

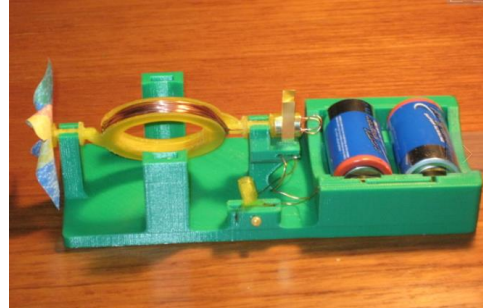

Figure 5. Direct current electric motor

#### IV. CONCLUSION

3D printers are very applicable high-tech tools for fabricating majority models and simple machines by students themselves. Students are to be involved not only in designing the project, but would also take part in the fabricating the models. School budget shortages caused need for making many models which demonstrate actual scientific phenomena which are abstract or not tangible. That enables students with lack of imagination see how some things look like and function. They will comprehend much easier once they have seen the 3D object which demonstrate the item or the process in question. The students involved in designing and fabrication processes will acquire the skills which could be applicable in their everyday life. When in need, make it by yourself the way it would suit you best. Selling the keychains and artefacts on students' market could refund the costs of printing and therefore explain how good entrepreneurs behave in manufacturing production in real life. They will learn more about real life from this extracurricular classes than they could on classes with theoretical approach.

The good thing about all this is that the project can be saved and reused in some other occasions. Hence, the complete work will not be for one class or use only.

#### REFERENCES

- [1.] <https://www.3dsourced.com/guides/history-of-3d-printing/>
- [2.] <https://resourced.prometheanworld.com/use-3d-printers-classroom/>
- [3.] <https://zortrax.com/applications/education>

# Virtual Laboratory as Progressive Web Application

N. Koceska\*, S. Koceski\*

\* Faculty of Computer Science, University Goce Delchev – Shtip, Shtip, R. North Macedonia  
{natasa.koceska, saso.koceski}@ugd.edu.mk

**Abstract - In contemporary education, especially in natural and technical sciences courses, it is important for students to gain practical experience through the use of laboratory exercises.**

Although theory classes were conducted online during the COVID-19 pandemic, educational institutions found it difficult to complete the laboratory experiments. With the increasing availability, sophistication and power of web-based tools and computer simulations, a growing number of virtual laboratories are developed and published.

In this study we are proposing an architecture for a virtual laboratory designed and developed as a progressive web application (PWA). The concept of the PWA together with its advantages are also explained in this paper.

## I. INTRODUCTION

The pace of information and communication technologies progress is so fast that novel products and solutions emerge almost on a daily basis, shaping our way of live. Recent advances in artificial intelligence (AI), robotics and IoT have contributed to development of multiple sectors [1-12]. In addition, contemporary smartphones are fare beyond just communication devices. They have been transformed into tools for healthcare, work, shopping and entertainment. All these technologies have significant impact and are transforming the education systems nowadays.

This has been especially evident during the latest COVID-19 pandemic. During the pandemics we have witnessed the largest disruption of education systems in history, affecting nearly 1.6 billion learners in more than 190 countries on all continents. All educational institutions in Republic of North Macedonia were also closed on March 10, 2020.

To ensure learning continuity during this disruption, educational institutions were constrained to adopt the online teaching and learning models in a relatively short period of time. This need for rapid shift to online learning revealed many problems in the education systems all over the globe but, it also revealed a deep gap in our overall approach to education [13]. One of the major problems in

Republic of North Macedonia, evidenced during the pandemics, was the access to education, especially for vulnerable groups, such as children at risk of poverty, Roma children and children with disabilities. Although multiple initiatives and institutions have tried to provide hardware devices (primarily portable devices), needed for the education process of these categories, continuous access to the online teaching and learning resources is still a big challenge.

In contemporary education, especially in natural and technical sciences courses, it is important for students to gain practical experience through the use of laboratory exercises.

Although theory classes were conducted online during the COVID-19 pandemic, educational institutions found it difficult to complete the laboratory experiments.

Many research studies have evidenced the fact that computer simulations i.e., virtual laboratories, can mimic the real-world laboratory workflow and have the potential to be a useful supplement to the theory classes.

With the increasing availability, sophistication and power of web-based tools and computer simulations, a growing number of virtual laboratories are developed and published [14-18]. They are also integrated with the existing learning management systems (LMS).

Most of the recently developed virtual laboratories are developed as a web-based applications suitable for usage on various devices, while some of them are published as a stand-alone software application aimed to be installed on desktop and mobile devices.

In this study we are proposing an architecture for a virtual laboratory designed and developed as a progressive web application (PWA). The concept of the PWA together with its advantages are also explained in this paper.



## II. PROGRESSIVE WEB APPLICATIONS – BASIC CONCEPTS

Until recently native mobile applications were the first choice for smartphones and tablets as hybrid cross-platform apps and web-apps for portable devices were lagging behind them. However, a new set of standards advocated by the Google Web Fundamentals group seeks to bridge that gap by introducing features such as offline support, background synchronization, and home-screen installation to the web [19]. These standards incited the development of new architecture type called Progressive Web App. PWAs already gained popularity in the last couple of years. Some studies and reports estimate that PWA will replace half the existing mobile applications based on native, hybrid, and mobile web architecture.

The main characteristics and advantages of PWAs are:

- Low Development and Maintenance Costs
- No Dependence on App Distribution Services
- App-Like Look and Feel
- Platform- and Device-Agnosticism
- No Updating Issues
- Fast Installation
- Better Performance
- Seamless Offline Operation
- Push Notification Functionality
- Enhanced Security
- Hardware Integration

PWAs are offering great hardware integration capabilities. This includes some of the following features:

- Geo-Location
- Real-Time Camera
- Data Storage
- Payments
- Biometric Authentication
- USB/Bluetooth
- Motion Sensors
- Native Push Notifications

Real-time content synchronization is what gives PWAs a significant advantage over native or hybrid mobile applications. Moreover, one of the biggest advantages is the fact that the data synchronization is possible even in the offline mode, and that is important for remote students who may be located in places where the internet coverage is intermittent.

## III. DESIGN PRINCIPLES OF THE VIRTUAL LABORATORY APPLICATION

In the design of the simulation two specific things are considered: Coherence Principle and Consistency.

Coherent principle argues that simulations may not contain unnecessary material that distract the student thus disrupts the learning process. Consistency between simulations is also very important. Users who have more experience with simulations will learn to use simulations faster if they have a consistent design.

With the simulations, students are provided with animated visual model for easier understanding of the physical phenomenon. By doing interaction with the simulation, the student can participate in changing the parameters and analysis of results. Therefore, it is necessary to take into account the design of the simulations, because students give equal importance to the overall visual design.

Simulations are not supposed to reflect the reality in details, but to maintain the concept of the physical area that they simulate. For simulation to be sufficiently realistic it is necessary to:

- implement connections and principles of the system which simulates;
- contain components with enough detail for the user to connect to the same components from the real world;
- allow the user to change parameters like in the real system;
- give the user the feeling that he or she directly controls the components of the simulation without any intermediate steps.

In short, the simulation should function as the actual system. Moreover, it should offer:

- a single and clear goal for the user;
- objects that can be interacted to successfully complete the simulation;
- environment that provides an appropriate context in the simulation;

- interactions, reactions, challenges, situations and effects that are equivalent to those of the real experiment;
- feedback after the simulation or the task is completed successfully;
- opportunities for returning simulation in initial state or to a previous state, such as back button or restart;
- allow users to have a sense that they control the application.

#### IV. PROPOSED ARCHITECTURE OF THE VIRTUAL LABORATORY APPLICATION

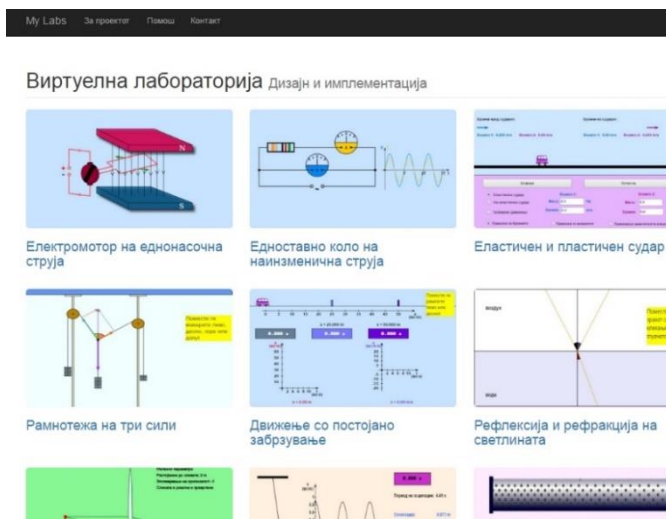

Figure 1. UI/UX of the developed Virtual Laboratory Application

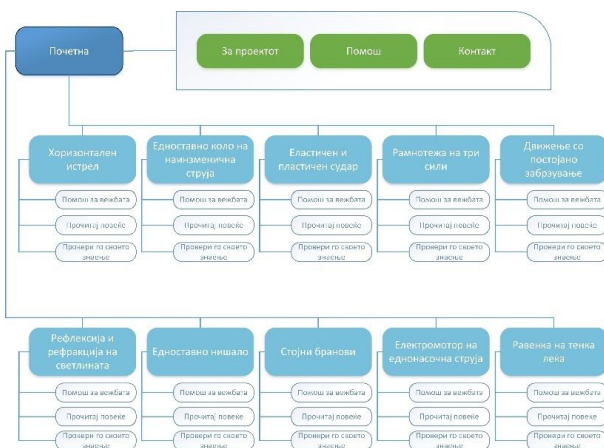

Figure 4. Site Diagram of the developed Virtual Laboratory

Usability of the traditional web applications as well as user experience can be significantly increased by transforming them into progressive.

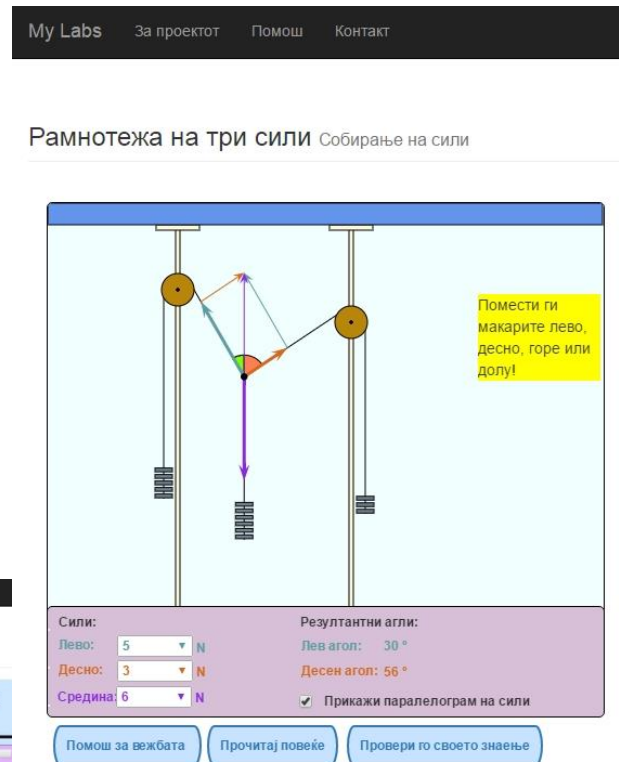

Figure 2. Lab exercise describing the concept of equilibrium of three forces

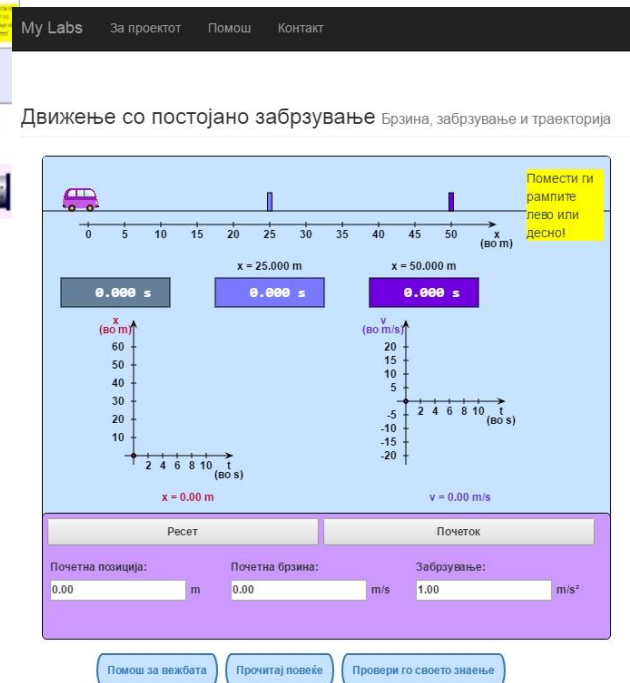

Figure 3. Lab exercise describing the concept of Motion with constant acceleration

The architecture of the PWA relies on two main components: App shell and Service Worker. Its architecture is given on the Figure 5.

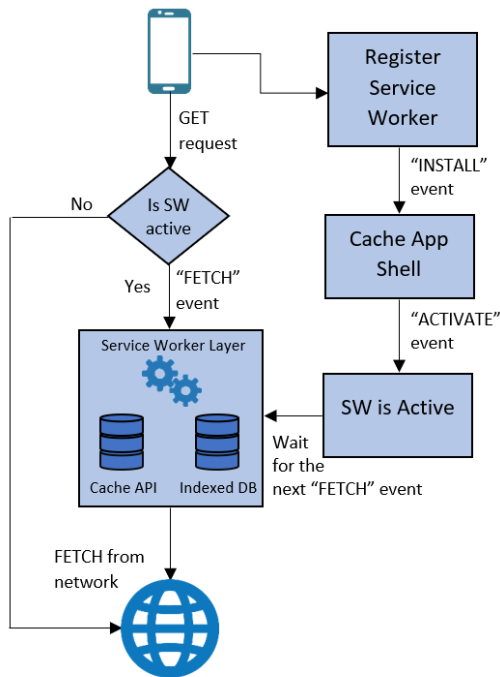

Figure 5. Proposed architecture of the Virtual Laboratory

#### A. App shell

The application shell contains the minimal portion of HTML, CSS, and JavaScript the necessary for creation of the user interface. In our case certain local resources like the navigation and footer bars as well as the graphical resources of the app are loaded in the shell just to provide a functional skeleton of the application.

Application shell also ensures that the loading time of the app will be reduced every time the user revisits the app. We have tested the performances on four laboratory exercises and the results are given in the Table I.

TABLE I. LOADING TIMES

Lab name	Loading Time for Repetitive Visits (ms)					Min. loading time
	Number of visits performed					
	1 <sup>st</sup>	2 <sup>nd</sup>	3 <sup>rd</sup>	4 <sup>th</sup>		
Motion with constant acceleration	2.36	1.86	1.07	0.86	0.86	
Equilibrium of three forces	2.15	1.32	0.76	0.81	0.76	
Accelerated movement	1.96	1.34	0.92	0.68	0.68	
Elastic and non elastic collisions	2.97	1.25	0.85	0.97	0.85	
Electric circuits	4.23	3.15	2.38	1.11	1.11	

#### B. Service worker

Service worker another very important component that provides the offline working mode of the web applications. However, the use of service worker is limited only to pre cache the resources and serve the content upon loading the page. This is performed during the background synchronization.

When the user makes a request to the server via the app in the absence of network, the request gets stored in the cache. Even if the user quits the app after making the request, it still gets stored up in the cache. As soon as the network connection is back, the request gets executed and the app is populated again with the requested data in the background.

Offline capability of an app can be implemented by using a client-side storage called IndexedDB.

#### V. CONCLUSION

In this study we are proposing an architecture for a virtual laboratory designed and developed as a progressive web application (PWA).

Students can benefit from the Virtual Laboratory developed as an educational PWA by its installation on the smartphone's home screen. Once installed, loading of the content becomes a breeze.

On the developers' side there are also multiple benefits. Namely, developers can easily add or remove some features without having to update the entire app, so real-time content syncing is what gives PWAs a considerable advantage over native apps.

Moreover, such synchronization is possible even in the offline mode, and that is important for remote students who may be located in places where the internet coverage is intermittent.

#### REFERENCES

- [1] Loshkovska, Suzana, and Saso Koceski, eds. ICT innovations 2015: Emerging technologies for better living. Vol. 399. Springer, 2015.
- [2] Davcev, K., Koceska, N., and Koceski, S. (2019). A review of robotic kits used for education purposes. In International Conference on Information Technology and Development of Education – ITRO 2019, 152–155.
- [3] Koceski, Saso, and Biljana Petrevska. "Empirical evidence of contribution to e-tourism by application of personalized tourism recommendation system." *Annals of the Alexandru Ioan Cuza University-Economics* 59, no. 1 (2012): 363-374.
- [4] Trajkovik, Vladimir, Elena Vlahu-Gjorgievska, Saso Koceski, and Igor Kulev. "General assisted living system architecture model." In International Conference on Mobile Networks and Management, pp. 329-343. Springer, Cham, 2014.
- [5] Stojanov, Done, and Saso Koceski. "Topological MRI prostate segmentation method." In Computer Science and Information Systems (FedCSIS), 2014 Federated Conference on, pp. 219- 225. IEEE, 2014

- [6] Koceski, Saso, and Natasa Koceska. "Evaluation of an assistive telepresence robot for elderly healthcare." *Journal of medical systems* 40, no. 5 (2016): 121.
- [7] Stojanov, Done, Aleksandra Mileva, and Sašo Koceski. "A new, space-efficient local pairwise alignment methodology." *Advanced Studies in Biology* 4, no. 2 (2012): 85-93.
- [8] Koceski, Saso, and Natasa Koceska. "Challenges of videoconferencing distance education-a student perspective." *International Journal of Information, Business and Management* 5, no. 2 (2013): 274.
- [9] Koceski, Saso, Natasa Koceska, and Ivica Kocev. "Design and evaluation of cell phone pointing interface for robot control." *International Journal of Advanced Robotic Systems* 9, no. 4 (2012): 135.
- [10] Koceski, Saso, Stojanche Panov, Natasa Koceska, Pierluigi Beomonte Zobel, and Francesco Durante. "A novel quad harmony search algorithm for grid-based path finding." *International Journal of Advanced Robotic Systems* 11, no. 9 (2014): 144.
- [11] Koceska, Natasa, Saso Koceski, Francesco Durante, Pierluigi Beomonte Zobel, and Terenziano Raparelli. "Control architecture of a 10 DOF lower limbs exoskeleton for gait rehabilitation." *International Journal of Advanced Robotic Systems* 10, no. 1 (2013): 68.
- [12] Serafimov, Kire, Dimitrija Angelkov, Natasa Koceska, and Saso Koceski. "Using mobile-phone accelerometer for gestural control of soccer robots." In *Embedded Computing (MECO), 2012 Mediterranean Conference on, Bar, Montenegro*, pp. 140- 143. 2012
- [13] Koceska, Natasa, Saso Koceski, Bore Pucovski, Vera Mitkovska, and Aleksandar Lazovski. "Investigating the Effects of Online and Flipped Classroom Approach during COVID-19 Pandemic." (2020): 42-47.
- [14] Caño de las Heras, Simoneta, Barbara Kensington-Miller, Brent Young, Vicente Gonzalez, Ulrich Krühne, Seyed Soheil Mansouri, and Saeid Baroutian. "Benefits and challenges of a virtual laboratory in chemical and biochemical engineering: students' experiences in fermentation." *Journal of Chemical Education* 98, no. 3 (2021): 866-875.
- [15] Gunawan, Gunawan, A. Harjono, H. Sahidu, and L. Herayanti. "Virtual laboratory to improve students' problem-solving skills on electricity concept." *Jurnal Pendidikan IPA Indonesia* 6, no. 2 (2017): 257-264.
- [16] Maulidah, Shopi Setiawati, and Eka Cahya Prima. "Using Physics Education Technology as Virtual Laboratory in Learning Waves and Sounds." *Journal of Science Learning* 1, no. 3 (2018): 116-121.
- [17] Kapilan, Natesan, P. Vidhya, and Xiao-Zhi Gao. "Virtual laboratory: A boon to the mechanical engineering education during covid-19 pandemic." *Higher Education for the Future* 8, no. 1 (2021): 31-46.
- [18] Durand, Marina de Toledo, Carolina Baraldi Araujo Restini, Amora CD Wolff, Milton Faria Jr, Lucélio Bernardes Couto, and Reinaldo Bulgarelli Bestetti. "Students' perception of animal or virtual laboratory in physiology practical classes in PBL medical hybrid curriculum." *Advances in physiology education* 43, no. 4 (2019): 451-457.
- [19] Bjørn-Hansen, Andreas, Tim A. Majchrzak, and Tor-Morten Grønli. "Progressive web apps: The possible web-native unifier for mobile development." In *International Conference on Web Information Systems and Technologies*, vol. 2, pp. 344-351. SciTePress, 2017.

# Improvement of the Static Characteristics of Pilot Operated Pressure Relief Valves

S. Dimitrov\*, D. Krstev\*, A. Krstev\*\*

\*Faculty of Mechanical Engineering, University of Stip, Republic of N. Macedonia,

\*\*Faculty of Computer Science, University of Stip, Republic of N. Macedonia,  
sasko.dimitrov@ugd.edu.mk, dejan.krstev@ugd.edu.mk, aleksandar.krstev@ugd.edu.mk

**Abstract** - Theoretical and experimental investigations of the static characteristics of pilot operated pressure relief valves is presented in this article. A mathematical model of pressure drop vs. flow depending of pilot operated pressure relief valves is developed. An experimental test stand was created for experimental investigation of the static characteristics and compared with each other which confirm the mathematical model. The results of solving the mathematical model and experimental investigation are presented in few diagrams. A few directions for improvement of the static characteristics are given, especially at the moment of opening of the main valve. Advantages and disadvantages of the static characteristics are discussed.

**Keywords:** flow, mathematical model, pressure, relief valve, static characteristics

## I. INTRODUCTION

Main feature of the static characteristic of the pressure relief valves is its slope, i.e. increasing of the adjusted value of the pressure when increasing the flow through the valve. This means that there is an error in the static characteristic. As an example, at fig.1 schematic layout of the theoretical static characteristic of direct operated and pilot operated pressure relief valve is shown [1].

With blue color a static characteristic of direct operated pressure relief valve is presented. The valve opens at pressure value  $p_1$  and with increasing of the inlet flow through the valve the pressure increasing up to  $p_0$  when the entire flow  $q_0$  passes through the valve. As can be seen, there is a deviation from the ideal static characteristic and at flow  $q_0$  through the valve, the error of the static characteristic is  $\Delta p_1 = p_0 - p_1$ . This error is caused by the deformation of the spring and the hydrodynamic force of the streaming flow [1].

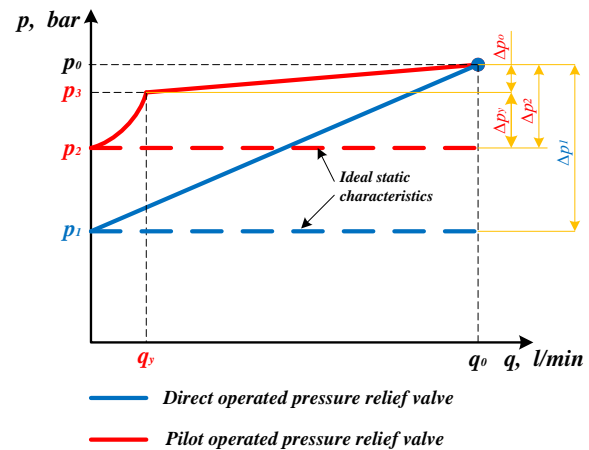

Figure 1. Static characteristic of pressure relief valves

On the same figure a theoretical static characteristics of pilot operated pressure relief valve is shown. At the static characteristic of pilot operated pressure relief valves, two zones are noted: the first one for inlet flow from 0 to  $q_y$  when only pilot valve is opened and the second one for inlet flow from  $q_y$  to maximal flow  $q_0$  when both the pilot and the main valve are opened [2],[3].

Increasing the system pressure in the hydraulic circuit, at pressure value  $p_2$  the pilot valve opens and a little amount of pilot oil flows through it. The main valve is still closed. The pressure in front of the valve continues to increase parabolic until the pressure value  $p_3$  is reached when the main valve opens. At the second zone the pressure increases linearly from  $p_3$  until  $p_0$  as inlet flow increasing up to the maximal value  $q_0$ . Total error of the valve is sum of the error of the pilot valve  $\Delta p_y = p_3 - p_2$  and of the error of the main valve  $\Delta p_0 = p_0 - p_3$  i.e.  $\Delta p_2 = \Delta p_y + \Delta p_0$ .

Comparing the static characteristics of direct operated and pilot operated pressure relief valve it can be seen that the accuracy of the adjusted pressure is higher with pilot operated pressure relief

valve, i.e.  $\Delta p_2 \ll \Delta p_1$ . A disadvantage of the static characteristic of pilot operated pressure relief valve is pressure difference between opening of the pilot and the main valve at first zone of the static characteristic i.e. error of the static characteristic at the beginning of opening of the valve. This error reduces the accuracy of the set pressure value. This error also increases energy loss and converted it into heat which leads to increasing of the temperature of the oil and decreasing the efficiency coefficient of the entire hydraulic system [2].

Additional decrease of the slope of the static characteristics of the conventional pilot operated pressure relief valves and additional reducing of the difference between the pressures of opening of the pilot valve and the main valve,  $\Delta p_y = p_3 - p_2$ , can be obtained with built-in compensating control piston in front of the pilot valve, presented in this article. [8], [9].

In [6] the authors have shown theoretically and experimentally the advantage of the pilot operated pressure relief valves-lower slope of the static characteristic of the valve. But it cannot be clearly seen the pressure difference between opening of the pilot and the main valve. In [5] a special attention has been taken to the influence of the hydrodynamic reaction force to the valve characteristics. Also, the author has investigated different designs of the resistance orifices in the pilot line to improve the characteristics of the valve. Most comprehensive theoretical mathematical model is presented in [4], in details explained and included all the factors influencing the quality of the static characteristics. This model was developed for valve with “pilot flow through main valve”. In this study this model has been little modified for valve with conventional design, mostly used nowadays. Another mathematical model of the static characteristics of pilot operated piston type pressure relief valve is presented in [10]. Experiments have proved the proposed model. Then fluid force exerted on a poppet of the pilot valve has been neglected, whereas that on a piston has been taken into consideration.

To improve the static characteristic of the valve the built-in compensating control piston with resistance orifice in it in the pilot line is taken into consideration. Expressions for the pressure-flow coefficient of the valve without compensating control piston and with compensating control piston are obtained numerically to determine the pressure-

flow coefficient of the valve. The influence of the diameter of the compensating control piston to the static characteristics of the valve is presented, as well. This study has experimentally proved the validity of this model.

## II. FUNCTIONAL DIAGRAM OF THE VALVE

On Fig. 2 a functional diagram of the pilot operated pressure relief valve with conventional design is shown.

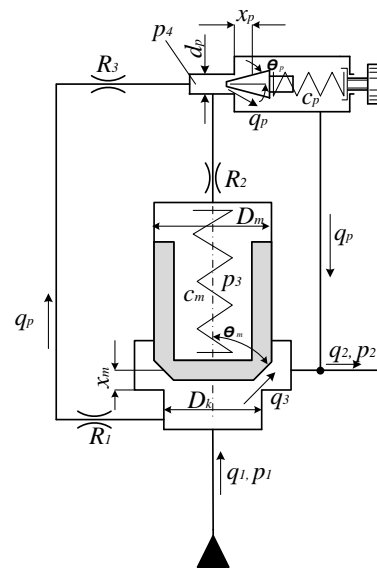

Figure 2. Functional diagram of conventional design of the pilot operated pressure relief valve

This valve can be observed as a system consisted of three subsystems: main valve, pilot valve and fixed orifice  $R_1$ . In neutral position both pilot and main valves are closed under the influence of the springs, and there is a balance of forces at the poppet of the main valve. When inlet pressure  $p_1$  reach the value of the preset spring force of the pilot valve, the poppet of the pilot valve is opening and through the orifices  $R_1$  and  $R_3$  beginning to flow some little amount of pilot flow  $q_p$ . The pressure  $p_3 \equiv p_4$  in the upper part of the main valve is maintaining approximately constant by the pilot valve. With further increase of the inlet pressure  $p_1$  the pressure drop  $p_{1,4} = p_1 - p_4$  continues to increase until the main valve opens and the flow  $q_1 = q_3 + q_p$  is flowing to the tank.

## III. MATHEMATICAL MODELING

Static characteristic of a pressure relief valve shows deviation of the inlet pressure in front of the

valve  $p_1$  as a control parameter, depending on the inlet flow  $q_1$  as an inlet parameter .

To model the static characteristics of the studied valve, the following assumptions are made in developing the mathematical model:

- The hydraulic fluid is ideal, nonviscous and incompressible. This assumption is close to reality under most conditions.
- The tank pressure and the pressure in the outlet line is constant and  $p_2 = 0$ .
- The flow rates through the throttling orifices of the valve are of high Reynolds number.

For theoretical determination of the static characteristics a methodology presented in [4] is used.

The static characteristics of the pilot operated pressure relief valves are described analysing the balance of forces acting on the pilot and the main poppet and the flow equation through the pilot valve, main valve and the orifices.

The flow rate  $q_y$  passing through the throttling area of the pilot valve is given by the following equation:

$$q_p = C_{d,p} \cdot d_p \cdot \pi \cdot \sin \theta_p \cdot \sqrt{\frac{2}{\rho} \cdot p_4} \cdot \frac{p_4 \cdot A_p - c_p \cdot h_p}{c_p + r_p \cdot p_4} \quad (3)$$

The pressure drop through the fixed orifices in the pilot line is given by the following equation:

$$p_{1,4} = R_l \cdot q_p + R_m \cdot q_p^2 \quad (4)$$

where  $p_{1,4}$  – the pressure drop through the orifices  $R_1$  and  $R_3$ ;  $R_l = R_{1l} + R_{3l}$  - the linear hydraulic resistance in the orifices  $R_1$  and  $R_3$ ;

$R_m = R_{1m} + R_{3m}$  - the local resistance in the orifices  $R_1$  and  $R_3$ .

The total pressure drop through the main valve can be expressed by the following equation:

$$p_{1,2} = p_{1,4} + p_{4,2} \quad (5)$$

Analysing the balance of forces acting on the poppet of the main valve, the motion of the main valve poppet can be described by the following equation:

$$q_p = C_{d,p} \cdot d_p \cdot \pi \cdot x_p \cdot \sin \theta_p \cdot \sqrt{\frac{2}{\rho} \cdot p_4} \quad (1)$$

where  $C_{d,p}$  – the discharge coefficient of the opening area of the pilot valve;  $d_p$  – the diameter of the seat of the pilot valve;  $x_p$  – the displacement of the pilot valve;  $\theta_p$  – the angle of the poppet of the pilot valve and  $p_4$  – the pressure drop in front of the pilot valve.

Analysing the balance of forces acting on the poppet of the pilot valve, the motion of the pilot poppet can be described by the following equation:

$$c_p \cdot (h_p + x_p) = p_4 \cdot A_p - r_p \cdot x_p \cdot p_4,$$

or

$$x_p = \frac{p_4 \cdot A_p - c_p \cdot h_p}{c_p + r_p \cdot p_4} \quad (2)$$

where  $A_p$  - the area of the seat of the pilot valve where the pressure  $p_4$  acts;  $c_p$  – the spring constant of the pilot valve spring;  $h_p$  – the previous spring deformation of the pilot valve;  $r_p = 2 \cdot C_{d,p} \cdot \pi \cdot d_p \cdot \sin \theta_p \cdot \cos \theta_p$  - the hydro-dynamic force coefficient of the pilot valve.

Combining the equations (1) and (2), the static characteristic of the pilot valve will be obtained:

$$p_{1,4} \cdot A_k - p_{1,2} \cdot \Delta A = c_m \cdot (h_m + x_m) + r_m \cdot x_m \cdot p_{1,2}$$

or

$$x_m = \frac{p_{1,4} \cdot A_k - p_{1,2} \cdot \Delta A - c_m \cdot h_m}{c_m + r_m \cdot p_{1,2}} \quad (6)$$

where  $x_m$  – the displacement of the poppet of the main valve;  $A_k$  - the area of the seat of the main valve;  $\Delta A = A_m - A_k$  - the unbalanced area at the poppet of the main valve;  $h_m$  – the previous deformation of the spring of the main valve;  $c_m$  – the spring constant of the main valve spring;  $r_m = 2 \cdot C_{d,m} \cdot \pi \cdot D_k \cdot \sin \theta_m \cdot \cos \theta_m$  - the hydrodynamic force coefficient of the main valve;  $C_{d,m}$  - the flow coefficient of the main valve;  $D_k$  - the diameter of the seat of the main valve;  $\theta_m$  - the angle of flowing of the oil in the main valve.

The flow rate  $q_3$  passing through the throttling area of the main valve is given by the following equation:

$$q_3 = C_{d,m} \cdot D_k \cdot \pi \cdot x_m \cdot \sin \theta_m \cdot \sqrt{\frac{2}{\rho} \cdot p_1} \quad (7)$$

The continuity equation at inlet port of the valve can be expressed by the equation:

$$q_{p,m,o} = \sqrt{\frac{p_{1,m,o} \cdot \varphi + \frac{c_m \cdot h_m}{A_k} - (R_{1l} + R_{3l}) \cdot q_{p,m,o}}{R_{1m} + R_{3m}}} \quad (9)$$

where  $q_{p,m,o}$  – the pilot flow at the moment of opening of the main valve;  $p_{1,m,o}$  – the pressure in front of the valve at the moment of opening of the main valve;  $\varphi = \Delta A / A_k$  – geometric parameter of the valve.

$$p_{1,m,o} = \frac{1}{1 - \varphi} \left( p_{1,op} + \frac{c_m \cdot h_m}{A_k} + \frac{x_p \cdot (c_p + r_p \cdot p_{4,op})}{A_p} \right) \quad (10)$$

where  $p_{1,op} = \frac{c_p \cdot h_p}{A_p}$  – the pressure in front of the valve at the moment of opening of the pilot valve;  $p_{4,op}$  – the pressure in front of the pilot valve at the moment of opening of the pilot valve.

#### IV. EXPERIMENTAL AND THEORETICAL STATIC CHARACTERISTICS

A pressure transducer type *HMI7* manufactured by *BoschRexroth* was used for pressure measurement. For displacement of the valve a position sensor manufactured by *BoschRexroth* was used. The measurement instruments were previously calibrated. The data are stored in the computer through 14 bit data acquisition card NI USB-6009 manufactured by *National Instruments*.

The subject of investigation was *Denison* pressure relief valve type *R4V 06*, shown on Fig. 3 [7].

The parameters of the specified pressure relief valve are:  $d_p = 5 \text{ mm}$ ,  $c_p = 250 \frac{\text{N}}{\text{mm}}$ ,  $C_{d,p} = 0.8$ ,  $\nu = 34 \text{ cSt}$ ,  $\rho = 890 \frac{\text{kg}}{\text{m}^3}$ ,  $d_{dr1} = d_{dr3} = 0.8 \text{ mm}$ ,  $l_{dr1} = l_{dr3} = 1 \text{ mm}$ ,  $D_k =$

$$q_1 = q_3 + q_y \quad (8)$$

The static characteristics of the pilot operated pressure relief valves are fully described by the equation (1) to (8). From equations (1) – (8) theoretically can be expressed the pilot flow (9) at the moment of opening of the main valve and by the iterative procedure can be calculated by the equation:

According to equation (9), the pilot flow directly depends on the geometric parameter of the valve  $\varphi$  and the resistance in the pilot orifices  $R_1$  and  $R_3$ .

The pressure in front of the valve at the moment of opening of the main valve is given by the following equation:

$28.5 \text{ mm}$ ,  $D_m = 28 \text{ mm}$ ,  $c_m = 7 \frac{\text{N}}{\text{mm}}$ ,  $h_m = 16.5 \text{ mm}$ ,  $C_{d,m} = 0.8$ .

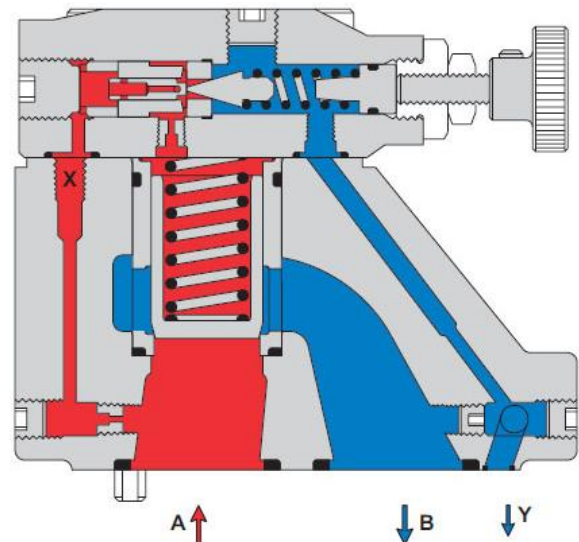
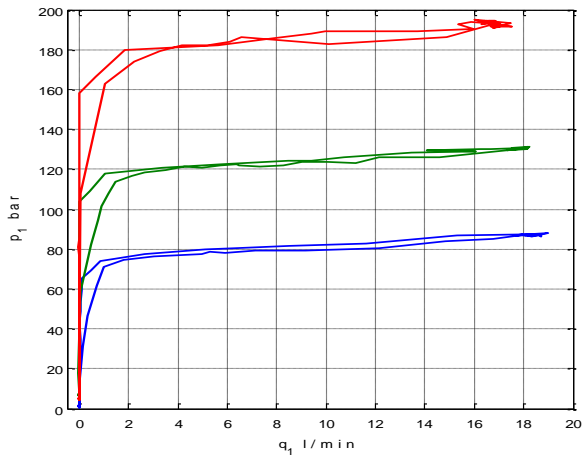

Figure 3. The studied pressure relief valve

Theoretical and experimental static characteristics are presented on Fig. 4. On the right side of the figures zoomed detail around the values of opening of the pilot and the main valves are presented.





a)

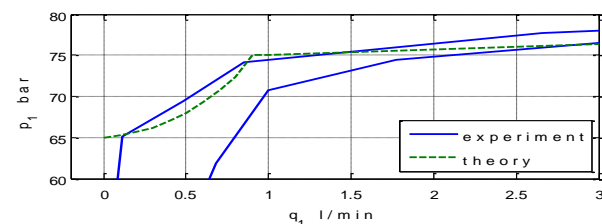
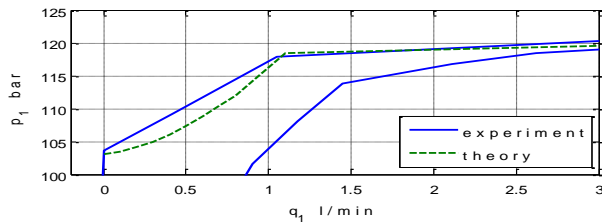

b)

Figure 4. Theoretical and experimental static characteristic of the studied valve

Fig. 4 shows the static characteristics of the studied valve. The beginning of the static characteristic, at a lower flow rate is shown in Fig. 4-b. It can be seen that the static characteristic is characterized by the pressure difference between the pressure of opening of the pilot and the main valve. At lower pressures this difference is of the order of 10 bar. While at higher pressure this difference is of the order of 15 bar. At even higher pressures, this difference is even higher - about 20 bar. The pilot flow at the moment of opening the main valve is from 0.8 l/min at lower pressure - about 65 bar, 1.1 l/min for pressure about 100 bar, to 2 l/min at higher pressure - about 160 bar.

If the unbalanced area of the main valve poppet is higher, the mistake of the controlled pressure at the beginning of opening of the main valve is even higher. The experimental static characteristic of the studied with higher  $\varphi$  is presented in Fig. 5.

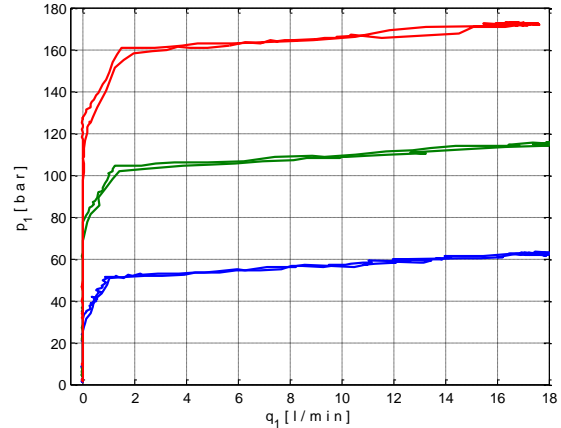

Figure 5. Experimental static characteristic of the studied valve with higher  $\varphi$

On the presented figures it is clearly visible that there is an error in the static characteristic of pilot operated pressure relief valves, especially at the beginning of opening of the valve. This error can be reduced with decreasing of the geometric parameter of the main valve spool  $\varphi$  or with inserting of a compensating control piston in front of the pilot valve.

## V. INFLUENCE OF THE COMPENSATING CONTROL PISTON ON THE STATIC CHARACTERISTICS

On Fig. 6 a functional diagram of the pilot operated pressure relief valve with compensating control piston is shown.

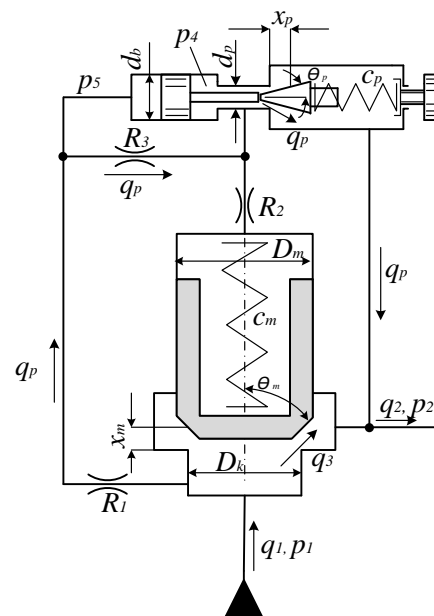

Figure 6. Functional diagram of pilot operated pressure relief valve with compensating control piston

The mathematical model of the static characteristics of the pilot operated pressure relief valve with compensating control piston is slightly modified. Taking into account the compensating control piston in front of the pilot valve, the equation (2) is converted into:

$$c_p \cdot (h_p + x_p) = p_4 \cdot A_p + p_{5,4} \cdot A_b - r_p \cdot x_p \cdot p_4,$$

or

$$x_p = \frac{p_4 \cdot A_p + p_{5,4} \cdot A_b - c_p \cdot h_p}{c_p + r_p \cdot p_4} \quad (11)$$

Where  $p_5$  – the pressure in front of the compensating control piston;  $A_b$  – the section area of the compensating control piston.

$$p_{1,mo} = \frac{1}{1 - \varphi} \left( p_{1,op} + \frac{c_m \cdot h_m}{A_k} + \frac{x_p \cdot (c_p + r_p \cdot p_{4,op})}{A_p} - \frac{A_b}{A_p} \cdot (R_{3l} \cdot q_{p,mo} + R_{3m} \cdot q_{p,mo}^2) \right) \quad (13)$$

Comparing the equations (10) and (13), the pressure in front of the valve at the moment of opening of the main valve with compensating control piston (eq. 13) is lower than the pressure in front of the valve at the moment of opening of the main valve without compensating control piston for the value of the  $\frac{A_b}{A_p} \cdot (R_{3l} \cdot q_{p,mo} + R_{3m} \cdot q_{p,mo}^2)$ .

Increasing the diameter of the compensating control piston, the value of this expression is higher, and the error of the static characteristic is lower.

Experimental confirmation of this statement is presented on the following figures.

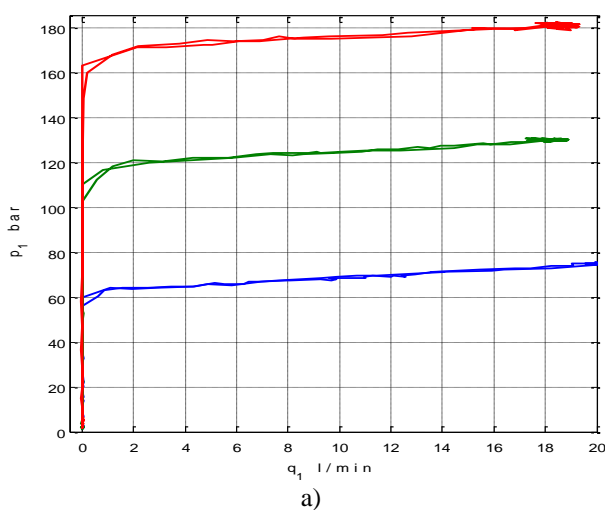

Combining the equations (1) and (11), the static characteristic of the pilot valve with compensating control piston is given by the equation:

$$q_p = C_{d,p} \cdot d_p \cdot \pi \cdot \sin \theta_p \cdot \sqrt{\frac{2}{\rho} \cdot p_4} \cdot \frac{p_4 \cdot A_p + p_{5,4} \cdot A_b - c_p \cdot h_p}{c_p + r_p \cdot p_4} \quad (12)$$

Then, the equation for the pressure in front of the valve at the moment of opening the main valve is converted into the following equations:

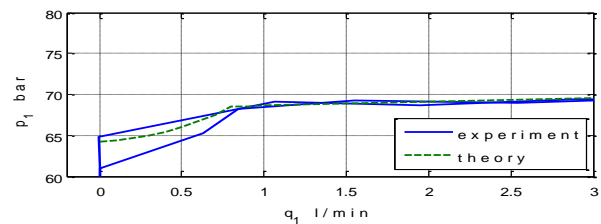
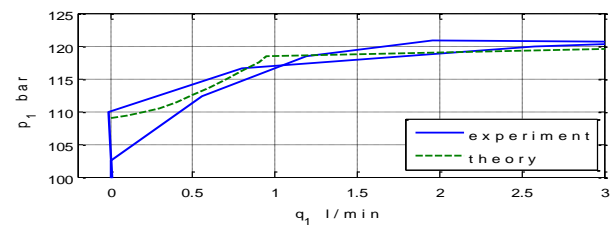
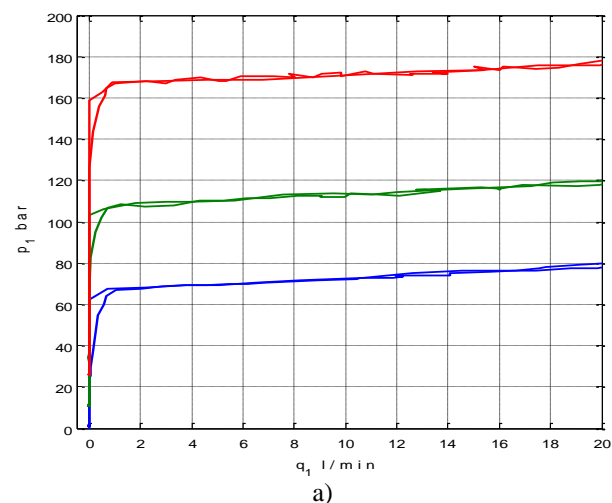

Figure 7. Theoretical and experimental static characteristic of the studied valve with compensating control piston of  $d_b = 5.5 \text{ mm}$



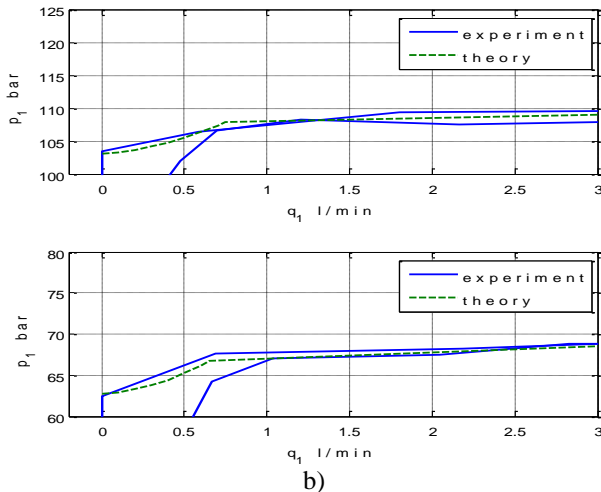

Figure 8. Theoretical and experimental static characteristic of the studied valve with compensating control piston of  $d_b = 6 \text{ mm}$

On Fig. 7 the static characteristic of the pilot operated pressure relief valve with compensation control piston of diameter  $d_b = 5.5 \text{ mm}$  is shown. On Fig. 8 the static characteristic of the pilot operated pressure relief valve with compensation control piston  $d_b = 6.0 \text{ mm}$  is shown. A comparison between experimental and theoretical static characteristic of the specified pressure relief valve, for two pressure settings-around 60 bar and around 100 bar, with compensation control piston  $d_b = 5.5 \text{ mm}$  (Fig. 7-b) and with compensation control piston  $d_b = 6.0 \text{ mm}$  (Fig. 8-b) is shown zoomed in for lower flows through the valve. It can be noticed that the presence of the compensating control piston reduces the pilot flow and the pressure difference, according to (13). The experimental investigation of the valve proved the proposed mathematical model for theoretical determination of the static characteristics of the pilot operated pressure relief valves with and without compensating control piston.

## VI. CONCLUSION

The static characteristics of the pilot operated pressure relief valves are characterized by a large relative error at the moment of opening of the pilot and the main valve, ie. with a large relative difference between the opening pressures of the pilot and the main valve. This disadvantage of the static characteristic of the pilot operated pressure relief valves can be reduced by various design modifications of some geometric parameters of the valve. This paper presents an improvement of the static characteristic of the pilot operated pressure relief valve by inserting a control piston in front of the control valve.

Experimental investigation proved the theoretical examination (10 and 13) that inserting a compensating control piston in front of the pilot valve can reduce the pilot flow and the pressure difference between opening of the pilot valve and the main valve. The error at the beginning of opening of the valve can be reduced if the relative ratio of the areas of the compensating piston and the seat of the pilot valve is increased. Fig. 4 shows that a valve without compensating control piston has pressure error of around 10 bar at 60 bar pressure setting and around 15 bar at 100 bar pressure setting. Inserting the compensating control piston with  $d_b=5.5 \text{ mm}$ , the pressure error is around 4 bar at 60 bar pressure setting and 8 bar at 100 bar pressure setting (Fig. 7). Inserting the compensating control piston with  $d_b=6.0 \text{ mm}$ , the pressure error is around 3 bar at 60 bar pressure setting and 5 bar at 100 bar pressure setting (Fig. 8). Theoretical investigation says that higher diameter of the compensating control piston  $d_b$  can much more reduce the pressure error (13), but it is possible the pressure-flow coefficient of the static characteristic of the valve to be negative in that case. According to equation (9) and (10) additional improvement – decreasing of the pilot oil flow and pressure difference between opening of the pilot and the main valve can be achieved by minimizing the geometric parameter  $\varphi$  of the main valve. It is experimentally proved by the fig.5.

## REFERENCES

- [1] Backé, W.; Murrenhoff, H. Grundlagen der Ölhydraulik, Institut für fluidtechnische Antriebe und Steuerungen. Technische Hochschule Aachen, 1994.
- [2] Will, D.; Ströhl, H.; Gebhardt, N. Hydraulik. Springer-Verlag, Berlin, 1999.
- [3] Brodowski, W. Beitrag zur Klärung des stationären und dynamischen Verhaltens direktwirkender Druckbegrenzungsventile. Dissertation, RWTH Aachen, 1974
- [4] Komitovski, M. Elements of hydro- and pneumo-drives (in Bulgarian). Technika, Sofia, 1985.
- [5] Wobben, G. D. Statisches und dynamisches Verhalten vorgesteuerter Druckbegrenzungs-ventile unter besonderer Berücksichtigung der Strömungskräfte. Dissertation, RWTH Aachen, 1978.
- [6] Takenaka, T.; Urata, E. Static and Dynamic Characteristics of Oil-Hydraulic Control Valves. Fluid Power International Conference, Tokyo, 1968.
- [7] DENISON HYDRAULICS GmbH. Pressure relief valve R4V. Catalogue sheet 3-EN 2400-A.
- [8] Dimitrov, S. Static characteristics of pilot operated pressure relief valves with compensating control piston. Scientific Conference EMF2011, Sozopol, Bulgaria, 2011, pp. 25-30.

- [9] Dimitrov, S. Transient response of a pilot operated pressure relief valve with compensating control piston. ANNALS of Faculty Engineering Hunedoara - International Journal of Engineering, ISSN 1584 – 2665, Tome XII, 2014, pp. 227-232.
- [10] Washio, S.; Nakamura, Y.; Yu, Y. Static characteristics of piston-type pilot relief valve. Proceedings of the Institution of the Mechanical Engineers, Part C, Vol 213, Issue 3, 1999
- [11] Amirante, R., Moscatelli, P.G., Catalano, L.A. Evaluation of the flow forces on a direct (single stage) proportional valve by means of a computational fluid dynamic analysis. Energy Conversion and Management 48 (2007) 942–953, Elsevier, 2007
- [12] Blackburn, J.F., Reethof, G., Shearer, J.L. Fluid Power Control. John Wiley & Sons, 1960
- [13] Dasgupta, K., Karmakar, R. Dynamic analyses of pilot operated pressure relief valves, Simulation Modelling Practice and Theory 10(2002) 35-49. Elsevier, 2002
- [14] Dasgupta, K., Watton, J. Dynamic analysis of proportional solenoid controlled piloted relief valve by bondgraph. Simulation Modeling Practice and Theory 13(2005) 21-38. Elsevier, 2005
- [22] Wu, D., Burton, R., Schoenau, G. An Empirical Discharge Coefficient Model for Orifice Flow. International Journal of Fluid Power, Vol. 3, No. 3, 13-18, 2002
- [15] Geissler, G. Optimierung und Einsatzgrenzen von Druckventilen. Dissertation, TU Dresden, 2002
- [16] Hos, C., Dynamic Behavior of Hydraulic Drives. Dissertation, Budapest University of Technology, 2005
- [17] Mokhtanadeh-Dehghan, M.R., Ladommatos, N., Brennan, T.J. Finite element analysis in a hydraulic pressure relief valve. Appl. Math. Modeling 1997, 21:437-445, Elsevier, 19
- [18] Pokki, J.P., Hurme, M., Aittamaa, J. Dynamic simulation of the behavior of pressure relief systems. Computers and Chemical Engineering 25 (2001) 793–798, Elsevier, 2001
- [19] Rabie, M.G., Kassim, S.A., Elsayed, S.A., Azis, M.A. Static and dynamic performance of pilot operated hydraulic relief valves. 4-th Conference on Aeronautical Sciences & Aviation Technology, Cairo, 1991
- [20] Storr, A. Beitrag zur Klärung des dynamischen Verhaltens vorgesteuerter, ölhydraulischer Druckregelventile. Dissertation, Technischen Hochschule Stuttgart, 1967
- [21] Wehner, D. Modellbasierter Systementwurf am Beispiel vorgesteuerter Druckbegrenzungsventile. Dissertation, RWTH Aachen, 2008
- [23] Zehner, F. Vorgesteuerte Druckventile mit direkter hydraulisch-mechanischer und elektrischer Druckmessung, Dissertation, RWTH Aachen, 1987

# Review of Sentinel-2 Applications

M. Kocaleva\* , B. Petrovska\*\*, N. Stojkovikj\*, A. Stojanova\*, B. Zlatanovska\*

\* Faculty of Computer Science, Goce Delcev University of Stip, North Macedonia

\*\* Military Academy “General Mihailo Apostolski”, University “Goce Delcev”, Stip, Macedonia  
mirjana.kocaleva@ugd.edu.mk, natasa.maksimova@ugd.edu.mk, aleksandra.stojanova@ugd.edu.mk,  
biljana.zlatanovska@ugd.edu.mk, biserka.petrovska@morm.gov.mk

**Abstract** - Nowadays with satellites monitoring, most easily can be seen daily changes of the land, climate and water. This paper presents a literature review of researches in the field of earth observation, in recent years is done. First an outline of Copernicus and Sentinel-2 data is given. Then, Sentinel-2 applications in remote sensing problems are evaluated. At the end, deep learning and CNN architecture applied on Sentinel-2 images are presented, as well as our next goals.

## I. INTRODUCTION

One of the basic fields in earth observation is collecting information about the earth's surface. The obtained data provide a better understanding of our planet and environment we live in, and thus serves as a core for making decision in several different domains. Optical satellites for Earth observation monitor our planet by obtaining images. They obtain images from ground, water, atmosphere and climate changes at different wavelengths of the electromagnetic spectrum [8], [3].

Widely known program for earth observation is Copernicus. Copernicus is European Union's program for earth monitoring. This program offers information based on satellite observations on the earth and non - space data. Copernicus has been especially designed to be suitable for customer necessity. Copernicus' services provide real-time data on a global level, which can be used for local and regional needs.

More recently, this data has become available to the public free. Since the launch of Sentinel-1A in 2014, the European Union has begun the process to set up nearly 20 satellites in orbit before 2030. Sentinel provides images with high temporal and spatial resolution. The Sentinel-2 data is publicly available at <https://scihub.copernicus.eu/> as part of the Copernicus program [7].

## II. SENTINEL-2

Sentinel-2 is a European mission for continuous, wide-range and high-resolution satellite images. Consist of two identical satellites Sentinel-2A and

Sentinel-2B set at 180 degrees. Sentinel-2A launched on 23 June 2015 and Sentinel-2B launched on 7 March 2017. Sentinel-2 satellites covers the following areas:

- all continental land surfaces (including groundwater) between the widths of 84 ° north and 56 ° south,
- all coastal waters to at least 20 km from the coast,
- all islands greater than 100 km<sup>2</sup>,
- all the islands in the EU,
- the Mediterranean Sea,
- all sealed seas (for example, the Caspian Sea).

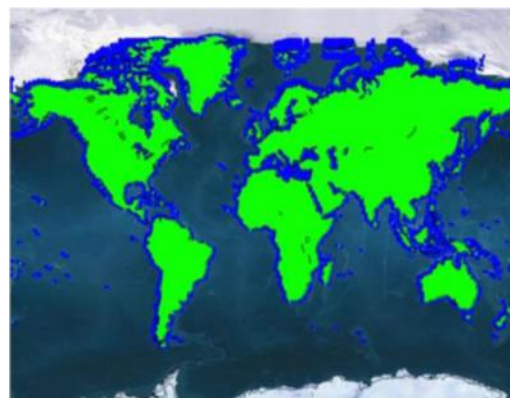

Figure 1. Sentinel-2 Coverage

The Sentinel-2 Multispectral instrument (MSI) consist of 13 spectral bands: four at 10 meters, six at 20 meters and three at 60 meters spatial resolution. The revisit time of one satellite is 10 days, or 5 days if they both work together. A swath width of each satellite is 290 km.

The data acquired from Sentinel-2 are used for:

- Land monitoring (spatial planning, agro-environmental monitoring, water monitoring, forest and vegetation

monitoring, carbon monitoring, monitoring of natural resources, monitoring of crops)

- Emergency management (natural disasters - floods, fires, landslides, storms, earthquakes, etc., technological accidents, humanitarian crises (for example, after a period of severe drought), civil crises.
- Security (border surveillance, maritime surveillance, support for external action of the EU).

There are many types of Sentinel-2 products. Products consist of fixed-size granules. Granule is the indivisible part of the product. The size of the granules depends on the type of product. Sentinel products include image data in JPEG2000 format, quality indicators, help data and metadata.

The products of Sentinel-2 are given in the Table 1:

TABLE I. SENTINEL-2 PRODUCT TYPES

name	availability	Data volume	Processing levels
Level 0	not available to users	granule (25x23 km <sup>2</sup> )	Payload Ground (PDGS) Data Segment
Level 1A	not available to users	granule (25x23 km <sup>2</sup> )	Payload Ground (PDGS). Data Segment
Level 1B	available to users	granule – 27MB (25x23 km <sup>2</sup> )	Payload Ground (PDGS). Data Segment
Level 1C	available to users	tiles – 500MB (100x100 km <sup>2</sup> )	Payload Ground (PDGS). Data Segment
Level 2A	available to users	tiles – 600MB (100x100 km <sup>2</sup> )	Sentinel-2 Toolbox

The radiometric resolution is expressed as an important number, usually in the range of 8 to 16 bits. The radiometric resolution of the MSI instrument is 12 bits, allowing image to be obtained in the range of 0 to 4 095 potential light intensity values. Radiometric accuracy is less than 5%. The radiometric resolution also depends on the detector's noise signal (SNR).

TABLE II. SPATIAL RESOLUTION BANDS AND SPECTRUM

Band number	Central wavelength (nm)	Bandwidth (nm)	Spatial resolution (m)	Part of spectrum	Description
1	443	20	60	Visible/VNIR	Coastal aerosol
2	490	65	10	Visible/VNIR	Blue
3	560	35	10	Visible/VNIR	Green
4	665	30	10	Visible/VNIR	Red
5	705	15	20	VNIR	Vegetation (red edge)

6	740	15	20	VNIR	Vegetation (red edge)
7	783	20	20	VNIR	Vegetation (red edge)
8	842	115	10	VNIR	NIR
8b	865	20	20	VNIR	Vegetation (red edge)
9	945	20	60	VNIR/SWIR	Water vapour
10	1375	30	60	SWIR	Cirrus
11	1610	90	20	SWIR	SWIR
12	2190	180	20	SWIR	SWIR

### III. SENTINEL-2 APPLICATIONS

There are so many problems in the scope of earth observation, so application on Sentinel-2 can be noted in many fields, like: spatial monitoring of changes in tropical forests [2], methods for mapping vegetation properties [3], identifying glacial features [4], mapping land use and land cover change [5], remote sensing of eelgrass [6].

Eliakim Hamunyela in his doctoral thesis "Spatial monitoring of changes in tropical forests using observations from multiple satellites" talks about how to improve satellite monitoring of forest changes by addressing key challenges that hinder correct and timely spotting of disturbances in forests from satellite data. More specifically, the thesis assesses whether the problem is with the season, a small-scale omission and low-scale and low-noise forest disorders, the innate noise in the time series of satellite images and inter-sensory differences in the multi-sensory time series. Researches were accomplished in wet tropical forests in Brazil and dry tropical forests with a strong season in Bolivia. In addition, a distinction between the spatial context model and the seasonal model is done. [2]

In paper [3], Juan Pablo collects the latest methods for optimized and automatic assessment of vegetation properties. His main goal was "To analyze, optimize and automate the most up-to-date methods for mapping vegetation properties in the preparation". A GUI software package called ARTMO (Automatic Radiative Transfer Modeler Operator) was developed. The tool was applied to the assessment of the LAI and the LCC in the agricultural place Barrack, Spain.

Ruben Egbers performs data processing and identifies the glacial features in Sentinel-2 images. The pretension of his research was to examine how Sentinel-2 images are processed and whether these images are useful for the study of glacial features such as snowy peaks. The operations of Sentinel-2

data were made in the Sentinel-2 Toolbox. He investigated mountain range named Karakoram, which includes several long glaciers, such as the Baltor glacier or the glacier Hisspar. Karakoram glaciers are not retreating, but receive a mass (Hewitt, 2005), which makes this area interesting for studying. [4]

The focus of this research was to map and analyze the land use and land cover (LULC) between 1999 and 2017 in Kalmar municipality, with a method for detecting changes in the object. The study of LULC changes is of great significance because there is a decline in agricultural land, a growing population, and a rise in urban areas. The outcome of LULC modification have bigger impact than climate change in the future. Object-based detection of changes between remote scanned images is conducive to the analysis of LULC changes. The research methods consisted of an object-based post-classification method, for detection of LULC changes. In order to achieve higher accuracy of classification, the method was combined with visual inspection and by manual re-classification of the wrongly classified objects. Four LULC classes were mapped and analyzed. Maps showed that between 1999 and 2017, urban land use increased by 7 km<sup>2</sup> and 20% and the agricultural lands decreased by 24 km<sup>2</sup> and -10%. The main drivers for the loss of agricultural land were the expansion of urban areas and the growth of vegetation. The results of this study have shown that the detection of object-based changes helps to gain insight into LULC changes over time. [5]

In paper [6] was investigate Eelgrass (a seafood with long strips of leaves that grow in coastal waters and salty pads) as an ecologically important and fragile kind of grass as a plant that lives in or near the sea that is common in Denmark and the Northern Hemisphere. The depth of the boundaries of the eelgrass population is used to assess the ecological status of coastal waters, and coverage is used to assess the health of ecosystems. This thesis was used Sentinel-2 images with object-based analysis and diverse machine-learning algorithms for classification of submerged water vegetation in the Roskilde Fjord. The results established that the Random Forest is the most suitable machine learning algorithm for classification of water vegetation, and a parameter on a scale of 10 produces images that receive the highest accuracy of the classification. [6]

In the papers above, Sentinel-2 satellite images were used in remote sensing problems. Despite that,

we are more interested about deep learning and CNN as deep learning architecture applied on Sentinel-2 images.

Deep learning is a new machine learning technique that learns features and tasks directly from data. Deep learning can be defined as AI method or techniques for learning in neural networks (ANNs) that contain more than one hidden layer. It is almost everywhere: Object recognition, Object classification, Object detection, segmentation, pose estimation, Image captioning, question answering, Machine translation, Speech recognition, Robotics [19], [20]. Many different architectures for deep learning exist such as deep neural networks, deep belief networks, recurrent neural networks and convolutional neural network. CNN is a combination of biology, math and computer science. CNN is comprised of several layers divided into two parts: feature learning (Conv, Relu, and Pool) and classification (FC and softmax). Every layer transforms an input 3D volume to an output 3D volume with some differentiable function that may or may not have parameters (e.g. Conv/FC do, ReLU /Pool do not). Each Layer may or may not have additional hyperparameters (e.g. Conv/FC/Pool do, ReLU doesn't). A classic CNN looks like

Input->Conv->ReLU->Conv->ReLU->Pool->ReLU->Conv->ReLU->Pool->Fully Connected

First layer in CNN is always a convolution layer where we use filter to get activation map (feature map) from an input image. There are also two main parameters that we can change to modify the behavior of each layer. They are stride and padding. The value of stride is mostly set on 1 or 2, and the value of padding on 0. The output from the convolution layer is calculated with equation  $output = (W - F + 2P) / S + 1$ . For example, if we have an input size [32x32x3], filter 5x5x3, stride 1 and padding 0, we will get the output =  $(32 - 5 + 2 * 0) / 1 + 1 = 28$ . ReLU is rectified linear units' layer that applies the function  $f(x) = \max(0, x)$  to all input values. This layer changes all the negative activations to zero. This layer does not change the size of the volume. Pooling layer or downsampling layer is layer for resizing images that gives on output the maximum numbers from each subregion. The Max pooling function is the most used type of pooling. Neurons in a fully connected layer have full connections to all activations in the previous layer. The last one uses a softmax activation function for classifying to compute the class scores. CNN are mostly applied to images, video and natural language processing [21], [22], [23]. CNN for image

classification start with low-level features like curves and edges and then building up more specific concept to recognize the classes. The network is usually trained by using backpropagation [14], [1]. The goal of back-propagation is to optimize the weights in order neural network to learn how to correctly map inputs to outputs. Back-propagation consist of three parts: forward pass, calculating the total error and backwards pass. The most common Convolutional Networks architectures are: LeNet (developed in 1998), AlexNet (2012), ZefNet (2014), VGGNet (2014), GoodLeNet (2015), ResNet (2016), Xception (2017), Convolutional Block Attention Module (2018), Channel Boosted CNN (2018) ... Deep learning and convolution neural networks, applied to satellite image recognition problems are presented in the following papers [8] - [13].

Since it is important to have information about the earth, LULC maps were created. LULC maps still took in manual work and data availability after long period (even a few years). Automatic methods for LULC classification exist, but there was a problem when they have a large-scale LULC classification. CNN cannot be directly applied to LULC. There were a small number of bases used to adapt the CNN to LULC classification. After acceptance of CNN architecture, they both were used for classification of Sentinel-2 images. Training data was taken from Sentinel-2. Researcher used annotation from OpenStreetMap database. TensorFlow framework and Inception-v3 CNN architecture were used. The result showed that CNNs were good for LULC classification. [8]

Several methodologies have been proposed for classification of satellite images, but CNN has proved to be one of the better ones and is therefore used in this paper [9]. In particular, a method for classifying a satellite image using CNN architecture was proposed. Six-layer CNN architecture consisting of an input layer, three convolution layers, two sub-sampling layers and at the end a fully connected layer is used. Satellite images were collected to apply the proposed CNN architecture. The database contained 6 classes of different areas (airport, bridge, forest, harbor, land and urban area) each of 200 images or total 1200 images. From each class 50 images were used for training, and the rest 150 for testing. According to the experiments carried out and the obtained results, it was shown that the proposed method for classification could be an encouraging alternative to existing schemes based on extraction for feature.

With the development of INSPIRE, a few Spatial Data Infrastructures (SDI) became publicly available. At the same time, Copernicus satellites (Sentinel) produce huge amounts of image data. For image processing U-net Convolution Neural Network (CNN) architecture was developed. The research was based in Netherlands. They classified six classes: build-up area, water, cropland, forest, grassland and undefined area. A comparison of the Convolution Neural Network (CNN) with the Random Forest model was also performed [10].

A challenge in satellite images is automatic target detection. Khan and al. [11] proposed a system for classifying target and non-target objects. They detected aircrafts. The system they proposed was based on EdgeBoxes and Convolutional Neural Network (CNN). The architecture of CNN contains five layers: two convolutional, two pooling and one fully connected layer. A military dataset consists of 500 aircraft images, 5000 non-aircraft and 26 test images. The test images were taken from Google Earth. The results shown that the proposed system was good for detecting aircrafts in satellite images.

Authors in paper [12] and [13] deal with HSR (high-resolution satellite) images. For image scene classification, [12] proposed an agile CNN architecture known as SatCNN. They have used convolutional layers with many small kernels and obtained average precision of around 99.65% for 40 minutes training. SAT data sets (SAT-4 and SAT-6) were used for training. SAT-4 consist of 500 000 and SAT-6 of 405 000 images covering four/six classes. The use of NVIDIA, CUDA and CuDNN library made convolutions to move more quickly. In the second paper [13] was proposed a new model (multi-scale CNN) for geospatial object detection in HRS images. For training were used NWPU VHR-10 datasets (positive dataset contains 650 images and the negative dataset contain 150 images) and the average precision of 89.6% was obtained.

#### IV. CONCLUSION

Sentinel-2 is one of the most essential data acquired for earth monitoring. In this article, we make a literature review (an overview) at recent studies in which researchers used image obtained from Sentinel-2 satellites in order to see the changes in the life environment. In addition, we are interested in research that make image classification using CNN and deep learning. Our aim is using CNN to make classification on Sentinel-2 and INSPIRE images to search for uncultivated workable land in Balkan Peninsula.



REFERENCES

- [1] Stutz, D, “Understanding convolutional neural networks”. In Seminar Report, Fakultät für Mathematik, Informatik und Naturwissenschaften Lehr-und Forschungsgebiet Informatik VIII Computer Vision, 2014.
- [2] Hamunyela, E, “Space-time monitoring of tropical forest changes using observations from multiple satellites”, 2017.
- [3] Rivera Caicedo, J. P, “Optimized and automated estimation of vegetation properties: Opportunities for Sentinel-2”, 2014.
- [4] Egbers, R, “Sentinel-2 data processing and identifying glacial features in Sentinel-2 imagery”, 2016.
- [5] Tijssen, M, “Mapping land use and landcover change in Kalmar,(Sweden) using object-based change detection”, Doctoral dissertation, University of Salzburg, 2018.
- [6] Ormond Fethers, J, “Remote Sensing of Eelgrass using Object Based Image Analysis and Sentinel-2 Imagery”, Master thesis, 2018.
- [7] “Copernicus Open Access Hub”. Available: <https://scihub.copernicus.eu/>, ESA 2014-2019.
- [8] Liebel, L, “Deep Convolutional Neural Networks for Semantic Segmentation of Multispectral Sentinel-2 Satellite Imagery: An Open Data Approach to Large-Scale Land Use and Land Cover Classification”, 2017.
- [9] Nguyen, T., Han, J., & Park, D. C, “Satellite image classification using convolutional learning”. In AIP Conference Proceedings (Vol. 1558, No. 1, pp. 2237-2240). AIP, 2013.
- [10] Delipetrev, B, “Sentinel 2 satellite images and INSPIRE SDI annotated datasets masks”, Mendeley Data, v1. Available: <https://data.mendeley.com/datasets/kmxgy6472h/1#folder-298788c8-4950-4adb-b290-f53929a60935>, 2018.
- [11] Khan, M. J., Yousaf, A., Javed, N., Nadeem, S., & Khurshid, K, “Automatic target detection in satellite images using deep learning”. *J. Space Technol.*, 7(1), 44-49, 2017.
- [12] Zhong, Y., Fei, F., Liu, Y., Zhao, B., Jiao, H., & Zhang, L, “SatCNN: satellite image dataset classification using agile convolutional neural networks”. *Remote sensing letters*, 8(2), 136-145, 2017.
- [13] Guo, W., Yang, W., Zhang, H., & Hua, G, “Geospatial object detection in high resolution satellite images based on multi-scale convolutional neural network”. *Remote Sensing*, 10(1), 131, 2018.
- [14] Doukkali, F, “Convolutional Neural Networks (CNN, or ConvNets)”. Available: <https://medium.com/@phidaouss/convolutional-neural-networks-cnn-or-convnets-d7c688b0a207>, 2017.
- [15] Tonchovska, R., Stanley, V., & De Martino, S, “Spatial Data Infrastructure and INSPIRE”. *ECA Knowledge Brief. Volume 55*, 2012.
- [16] Toshniwal, M, “Satellite image classification using neural networks”. In 3rd International Conference: Sciences of Electronic, Technologies of Information and Telecommunications (pp. 27-31), 2005.
- [17] Scarpa, G., Gargiulo, M., Mazza, A., & Gaetano, R, “A CNN-based fusion method for feature extraction from sentinel data”. *Remote Sensing*, 10(2), 236, 2018.
- [18] Ndikumana, E., Ho Tong Minh, D., Baghdadi, N., Courault, D., & Hossard, L, “Deep recurrent neural network for agricultural classification using multitemporal SAR Sentinel-1 for Camargue, France”. *Remote Sensing*, 10(8), 1217, 2018.
- [19] Jones, M. T, “Deep learning architectures”. Available: <https://www.ibm.com/developerworks/library/cc-machine-learning-deep-learning-architectures/index.html>, 2017.
- [20] UVA deep learning course. “Introduction to Neural Networks and Deep Learning”. Available: <https://uvadlc.github.io/> (Accessed on 17.03.2018)
- [21] Wu, J, “Introduction to convolutional neural networks”. National Key Lab for Novel Software Technology. Nanjing University. China, 2017.
- [22] Britz, D, “Understanding Convolutional neural networks for NLP”. Available: <http://www.wildml.com/2015/11/understanding-convolutional-neuralnetworks-for-nlp/>, 2015.
- [23] Deshpande, A, “A Beginner's Guide To Understanding Convolutional Neural Networks”. Available: <https://adeshpande3.github.io/adeshpande3.github.io/A-Beginner's-Guide-To-Understanding-Convolutional-Neural-Networks/>, 2016

# Review on Deep Learning Architectures

S. Arsovski\*, B. Markoski\*\*, V. Premcevski\*\*, P. Vasiljevic\*\*\*, A. Sofic\*\*\*\*

\*Raffles University, Johor Malaysia,

\*\*University of Novi Sad, Technical Faculty “Mihajlo Pupin”, Zrenjanin, Republic of Serbia

\*\*\* Higher Education Technical School of professional studies, Republic of Serbia

\*\*\*\*University of Novi Sad, Faculty of Technical Science, Republic of Serbia

sasa.arsovski@gmail.com, markoni@uns.ac.rs, velibor.premcevski@tfzr.rs, vasiljevic@vtsns.edu.rs,  
sofic.ftn@gmail.com

**Abstract - Deep Learning (DL) has been showing promising results for solving problems related to the text and Natural Language Processing (NLP), computer vision and audio processing. Deep learning or hierarchical learning is a subfield of machine learning which is based on learning data representations using deep neural networks. Deep Learning techniques and methods include a wide range of applications. In this survey we will present state of the art techniques, theoretical framework and DL algorithms and architectures.**

## I. INTRODUCTION

Earliest work on machine learning was during the 1940s. Being inspired by Principia Mathematica [1], where McCulloch and Pitts, brought together and developed logic unit with threshold technique [2]. This technique was inspired by the “all or none” character of nervous activity where each logic unit or “neuron” comes with a binary threshold activation function which were analogous to the first order logic sentences [2]. Later in the late 1940s, Donald Hebb combined two realms of human perception, namely the mind and behavior into a single theory known as Hebbian Theory [3] which could be basically summarized into a single sentence - Neurons that fire together, wire together!

However, Frank Rosenblatt created the “Perceptron” in 1958. “Perceptron” was the precursor of modern neural networks, which are basically today known as a supervised learning of binary classifiers algorithm [4]. The Perceptron

received much attention during the time due to its capability to conduct “online-learning” [5]. Frank Rosenblatt’s confidence in his work as the true AI was soon proven to be obsolete when the algorithm was proven its failure to recognize many classes of patterns such as simple non-linear function e.g. simple exclusive-or (XOR) function by Marvin Minsky in 1969. [6].

Backpropagation algorithm was proposed in the late 1970s [7], and the inability of neural nets to handle non-linear functions observed significant improvements in results due to the additional layers added to the neural nets. The Backpropagation algorithm works by back-propagating derivative of loss functions, or, errors, back to the network to update the parameters in the lower layers. The success of this algorithm led to developments of Hierarchical multilayered ANN and Convolutional Neural Networks [8] that were able to recognize handwritten digits [9].

In 2006, neural networks were rebranded as “deep learning” when Hinton introduced the idea of unsupervised pretraining and deep belief nets [10] where simple 2-layer model were trained unsupervised, and a new layer is added on top while the parameters are trained for the new layers. Layers are continuously trained and added in a greedy fashion until a deep network is obtained Figure 1.

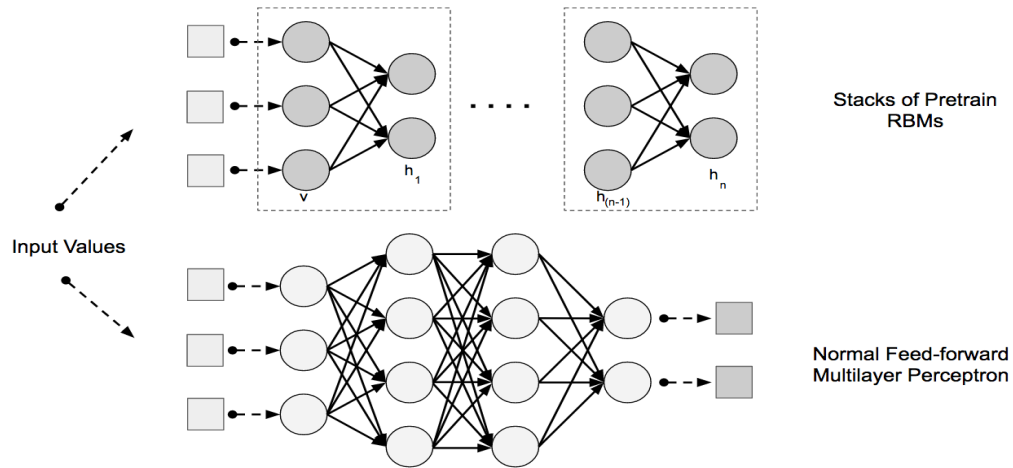

Figure 1. Deep belief Networks

From 2012. and beyond, the availability of large amount of data following the age of the Internet and advancement in use of hardware such as graphical processing units (GPU) which allows larger models to be trained more efficiently gave rise to numerous breakthroughs in Neural Network.

AI revolution has been one of the hottest topics lately due to the implementation of Deep Learning Neural Network technology. Although Neural Networks has been around for several decades, three factors have been identified as the major drivers of its recent research growth and outburst. These factors include:

#### A. Availability of data

Data availability has increased. In fact, ninety percent of the digital data in the world today has been created in the past two years alone.

#### B. Progress made in key algorithms

Key algorithms have improved. The algorithms and approaches that now dominate the discipline—such as deep supervised learning, unsupervised learning and reinforcement learning—share a vital basic property: Their results improve with the size and amount of training data.

In supervised learning, datasets are labeled with a collection of features. In supervised learning, model should extract meanings and key features from the analyzed data.

The case of reinforcement learning, an agent operates in the real or simulated environment and learn from the feedback given by the system.

#### C. Improvement on hardware

Hardware speed has improved. By a fortuitous coincidence, a type of computer chip called a graphics processing unit, or GPU turns out to be very effective when applied to the types of calculations needed by the robust algorithms. According to Shane Legg, a co-founder of Google DeepMind, training that takes one day on a single TPU device would have taken a quarter of a million years on an 80486 processor from 1990.

Deep Learning has the potential to significantly boost the economy and help to address some the world's daunting challenges (e.g. climate change, healthcare, and education), by facilitating knowledge discovery in different domains of the society.

The key intent of this survey is to present state of the art applications, theoretical framework, and DL algorithms, in text and natural language processing, computer vision and audio processing.

This paper is organized as follows: The second section Deep learning Neural Network architecture and state of the art NN models. The third provides an overview of the state-of-the-art deep learning approaches, techniques and applications in the text and natural language processing. The fourth section presents an overview of the state-of-the-art deep learning approaches, techniques, and applications in the computer vision. The fifth section an overview of the state-of-the-art deep learning approaches, techniques, and applications in the audio processing. In the last, sixth section, concluding remarks are given.

## II. ARCHITECTURE OF THE DEEP NEURAL NETWORKS

According to the authors in [6] there are four, major architecture of Deep Networks:

- Unsupervised Pretrained Networks (UPNs)
- Convolutional Neural Networks (CNNs)
- Recurrent Neural Networks
- Recursive Neural Networks

Due to the similarity between Recurrent Neural Networks and Recursive Neural Networks, in this

paper we will focus on the description of Recurrent Neural Networks.

Generative Adversarial Networks (GANs) [11] are great examples of Unsupervised Pretrained Networks (UPNs) which has been shown to be great at synthesizing images, sounds, videos [12] and even images from text descriptions [13]. GANs work by utilizing unsupervised learning to train two models in parallel (Figure 2). GANs limit a small number of parameters with respect to the amount of data used to train the network hence forcing the network to efficiently represent the training data, producing data that is similar to the training data

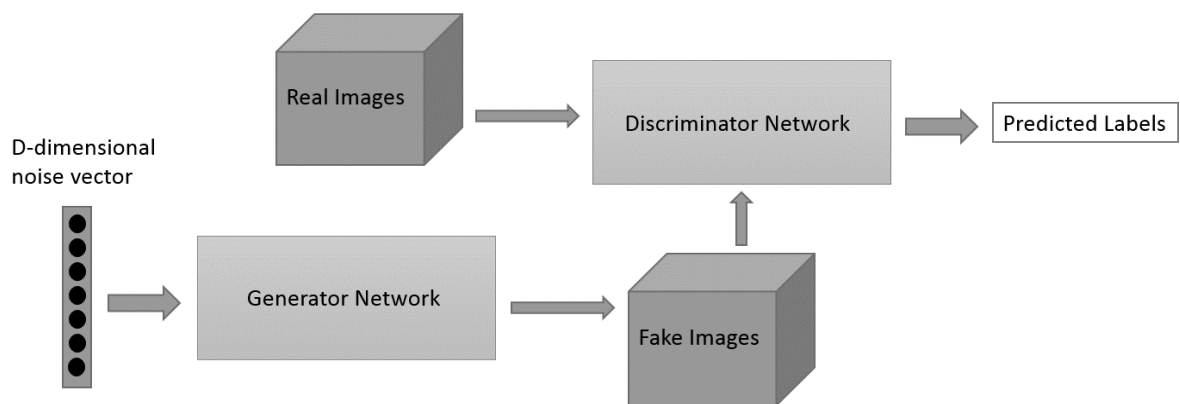

Figure 2. Generative Adversarial Networks

Out of these architectures, CNNs and Recurrent Neural Networks (LSTMs) are most utilized and researched as the performances of these architectures in image modeling for CNNs and sequence modeling for LSTMs greatly surpassed other models.

Convolutional Neural Networks (CNNs) [14] works with the aim of learning higher order feature orders in data using convolutions. The strength in performance of CNNs in analyzing wide variety of visual data making it consistently topping image classification competitions. Its object recognition properties are one of the reasons the power of deep learning is acknowledged by the world. Architecture of CNNs (Figure 3), a higher-level function converts input data obtained from the input layer through all connected layers into class scores which will then be produced by the output layer. In the input layer, 3-D

input (e width x height of image) as well as depth representing the color channels (e.g. RGB color channels). The layers followed by the input layers are called the feature extraction layers which consists of convolutional layers and pooling layer. These two layers repeat in pattern of sequence forming the feature-extraction layers which construct higher-order features based on the number of features found in the data. The higher-order features produced are then fed in the classification layers and produce scores. These layers are connected completely to the neurons in the previous layer, outputting 2-D output made of number of examples in the mini-batch in one dimension and number of classes designated for scoring in another. CNNs exploit spatially local correlation by enforcing a local connectivity pattern between neurons of adjacent layers as shown in the Figure. 3.

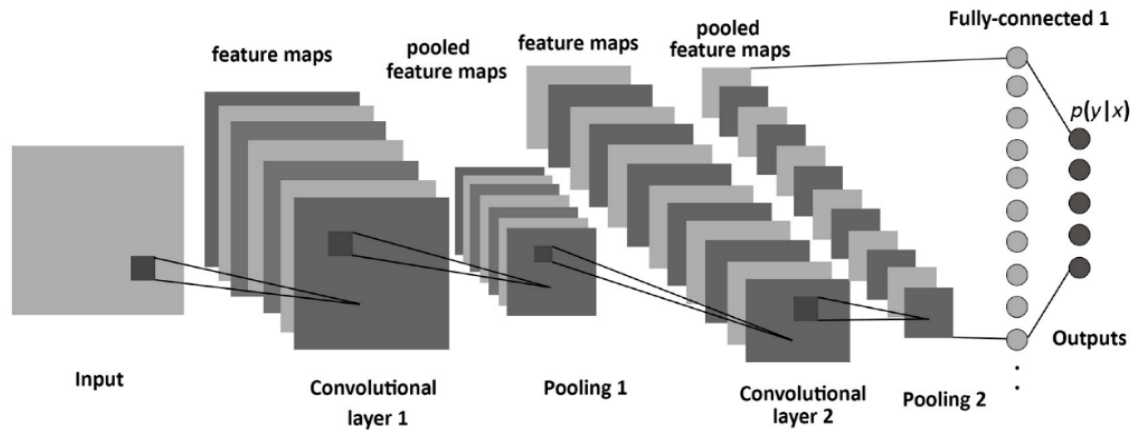

Figure 3. A simple illustration of the CNN

A feature map is obtained by repeated application of a function across sub regions of the entire image, in other words, by convolution of the input image with a linear filter, adding a bias term and then, applying a nonlinear function.

Recurrent Neural Networks (RNNs) are part of the feed-forward neural networks family, differing from feed-forward neural network only in the ability of information being transmitted through the time-steps [15]. Advancement of research in fields such as parallel-computing, use of graphical processing units (GPUs), optimization and network architectures have made RNNs more practical for researchers and applications. RNNs take each vector from a sequence of vectors from the input then modeling them one by one, hence allowing retain of state of the network while modeling each input vector for each sequence of input vectors. The

recurrent connections of RNNs enables the model to incorporate the concept of time as these recurrent connections span previous time-step (Figure 4.). The ability to incorporate concept of time of RNNs laid a foundation for RNNs to include input vector from previous time-step to produce current output at current time-step via recurrent connections. This is made possible because at each time-step of a recurrent network, input, and input activations from current input vector as well as hidden nodes in the previous state of the network are received at the nodes. Subsequently, output is computed from the hidden state at each time-step. Therefore, allowing current output to incorporate influence from previous input vector through the recurrent connections as well making it extremely useful for sequence modeling.

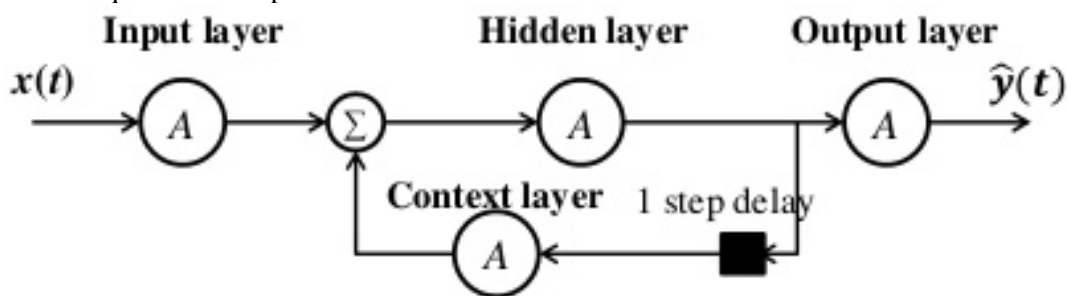

Figure 4. Basic RNN – Vanilla

The most used variation of RNNs is the Long Short-Term Memory (LSTM) network [16]. What makes LSTM network is its memory cell and the

gates, such as the input gates and forget gates as shown on the Figure 5. Input gates and forget gates of LSTMs modulate the data within memory cell.

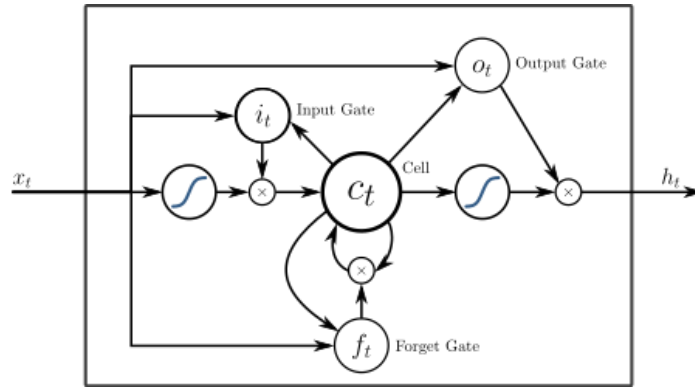

Figure 5. LSTM architecture [16]

The contents of the memory cell will not be affected when the two gates are not functioning from one time-step to another. The gating structure allows certain information to be kept through many time-steps, allowing the vanishing gradient problem experienced by Recurrent Neural Network to be solved.

#### A. Deep Learning Network Architecture – state of the art

ThalNet model is a modular neural network inspired by neocortical communication via the thalamus. It comprises a tuple of computation modules that route their respective features into a shared center vector, which is then read selectively by each module to obtain its recurrent context input. It is shown that the model learns to route information hierarchically [17] (Figure 6.)

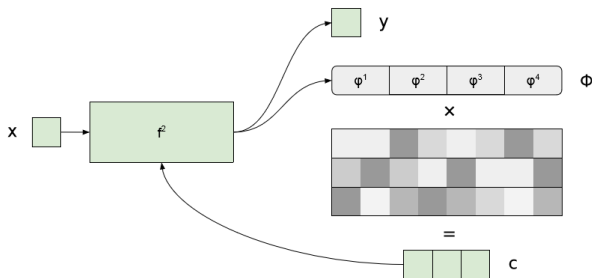

Figure 6. ThalNet [17]

In the ThalNet network model, module receive input  $x$ , and produces features to the center  $\Phi$  and output  $Y$ . Its context input  $c_i$  is determined as a linear mapping of the center features from the previous time step.

In the [18] authors propose outrageously large neural networks - Sparsely-Gated Mixture-of-Experts (MoE) layer where each sample only activates a sparse subset of many expert networks, determined by a gating network. The layer is embedded in a larger architecture that is overall trainable by backpropagation [18] (Figure 7.)

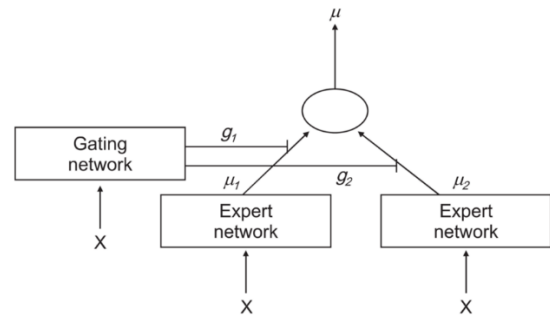

Figure 7. Sparsely-Gated Mixture-of-Experts (MoE) layer [18]

Evolutionary Algorithms [69]- showed that network weights encoded dimensions of image variations that are sensible to humans, possibly due to the diversity of environmental selection (Figure 8.).

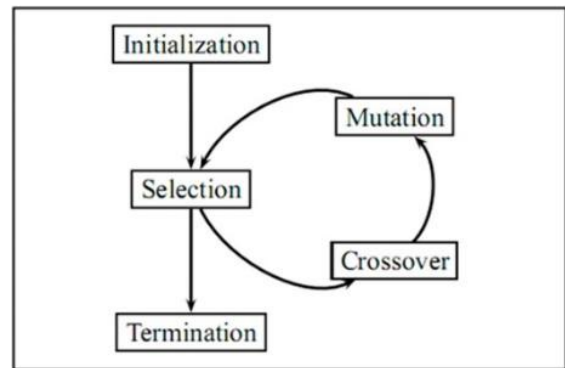

Figure 8. Evolutionary Algorithms

#### B. Capsule Networks

Capsules Networks proposed by Hinton (2017) - Capsules are small groups of neurons that act together like a node in a layer of a deep neural network. With capsule network [19], layers are comprised not of individual artificial neurons (ANs) but in a small group of ANs arranged in functional pods or capsules plus decrease the error rate compared to Ans (Figure 9.)

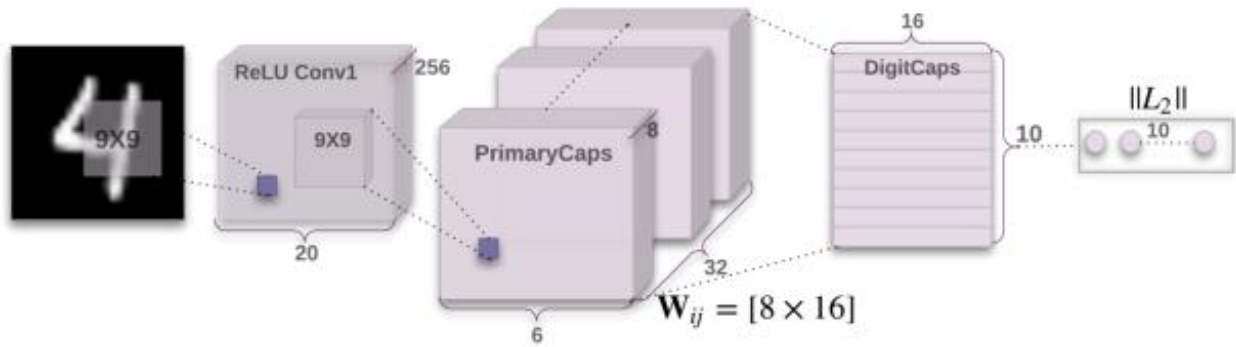

Figure 9. Capsule Networks

As shown on the Figure 9., the length of the activity vector of each capsule in DigitCaps layer indicates presence of an instance of each class and is used to calculate the classification loss.  $W_{ij}$  is a weight matrix between each  $u_i, i \in (1, 32 \times 6 \times 6)$  in Primary Capsules and  $v_j, j \in (1, 10)$ . In [20] authors propose a dynamic routing algorithm where each capsule in the current layer computes a “prediction vector” for each possible parent in the layer above by multiplying the child capsule’s own output by a weight matrix. If this prediction agrees with the output of the parent, these two capsules become more “coupled” in the next iteration. This routing operation iterates a few times between a pair of consecutive layers. Research on recurrent neural networks for speech recognition could be done in this area of research as well.

### C. Initialization methods

State of the art initialization methods – For a self-normalizing neural network (SNN) [21], the weights in a feed-forward neural network are initialized in such a way that, for any unit in a higher layer with input weights. Under these conditions, the activations in a layer converge towards zero mean and unit variance as they propagate through many network layers. This is an alternative method to normalize network activations that motivated popular techniques like batch and layer normalization. For the activation function, Scaled Exponential Linear Units (SELUs) was proposed to render a FNN as self-normalizing (Figure 10.). Thus, we can prove the self-normalizing property even for weight vectors that are not normalized so that the self-normalizing property can be kept during learning and weight changes. Research on new types of the Activation Function and Label Smoothing techniques that will improve model performances could possibly be done as an extension of this area in the future.

$$\text{selu}(x) = \lambda \begin{cases} x & \text{if } x > 0 \\ \alpha e^x - \alpha & \text{if } x \leq 0 \end{cases}$$

Figure 10. Scaled Exponential Linear Units

## III. LEARNING ARCHITECTURES

### A. Standard learning architectures

Authors in the [22] demonstrate that standard learning architectures are expressive enough to fit commonly used image classification datasets such as CIFAR 10 and ImageNet with random labels or random pixels. Obviously, these trained models don’t generalize to the equally random test sets. Therefore, the key reasons that deep learning generalizes in practice must not be the ones that apply to the random setup. Deep neural nets tend to prioritize learning simple patterns first, and appropriately tuned explicit regularization (e.g., dropout) can degrade training performance on noise datasets without compromising generalization on real data. Authors in [22] hypothesize that this is because generalizable solutions are easier to find and observe that the sharpness around local minima increases with the level of noise. It is also well known that sharp minima generalize poorly. Intuitively, this is because a local minimum for the test set likely differs slightly from the minimum for the training set. When the minima are sharp, this small difference translates to large degradation of model performance.

Studies on the relations between a model minima and data could be done further in the future due to the fact that recovering the global minimum becomes harder as the network size increases and that it is in practice irrelevant as global minimum often leads to overfitting. Numerical evidence could be presented such that large-batch stochastic gradient descent (SGD) tends to converge to sharp minima, but small-batch methods consistently

converge to flat minima, which should exist for real data given that they afford generalizable models.

### B. Reinforcement learning algorithms

Deep Q-Network (DQN) algorithm proposed by [23] to learn a target by minimizing a loss function. To reduce the DQN algorithm's overestimation problem, authors [24] proposed the double DQN (DDQN) algorithm. Authors [24] proposed the Deep Q-Learning from Demonstrations (DQfD) algorithm where a combination of the double DQN loss, a supervised large margin classification loss and regularization loss. To improve performance over DQN and DDQN authors [25] proposes repeatedly retraining the weights of the last hidden layer of the deep Q-networks. The training is based on least squares shallow learning method where it is essential to use a Bayesian regularization that treats the last layer's weights as a Bayesian prior. Future work on this area of research includes work on Policy-Based Reinforcement Learning Algorithms and Continuous actions algorithms that could use next-step prediction to model the values and policies over discretized dimensions, and value distribution. Models for the value distributions could be built using a quantile of the target distribution and develop the new regression algorithms.

### C. Neural Network reasoning

Using Reasoning Networks, authors in [26] achieve state of the art performance on a challenging visual QA dataset CLEVR. An RN is a critical component in the core of an Interaction Net, without which a Visual Interaction Network performs much worse in tasks of predicting the trajectory of simulated physical objects. It is worth noting that the presence of noise from a visual encoder enhanced the performance of its downstream Interaction Network that reasons purely in the states of objects. This is a good example where additional intelligence emerges from the composition of simple modules. Relational reasoning is a principal component of generally intelligent behavior but has proven difficult for neural networks to learn. In this paper, authors describe how to use Relation Networks (RNs) as a simple plug-and-play module to solve problems that fundamentally hinge on relational reasoning. Authors [26] stated that RN deep learning architecture can discover and learn how to reason about entities and their relations.

Reasoning NNs are a potential venue for a breakthrough towards AI that is now hopeful to be found. Reasoning Networks can be used for a

variety of problems that can benefit from structure learning and exploitation, such as rich scene understanding in RL agents, modelling social networks, and abstract problem-solving. Future work could also improve the efficiency of RN computations. An important direction is exercising this option in circumstances with strict computational constraints, where, for instance, attentional mechanisms could be used to filter unimportant relations and thus bound the otherwise quadratic complexity of the number of considered pairwise relations.

## IV. CONCLUSION

This survey presents an overview of Deep Learning state of the art present state of the art techniques, theoretical framework and DL algorithms and architectures. Authors provide a detailed view of four major deep neural networks categories and state of the art models. Authors opinion is that Reasoning NNs are a potential venue for a breakthrough towards AI that is now hopeful to be found. Reasoning Networks can be used for a variety of problems that can benefit from structure learning and exploitation, such as rich scene understanding in RL agents, modelling social networks, and abstract problem-solving. Future work could also improve the efficiency of RN computations. An important direction is exercising this option in circumstances with strict computational constraints, where, for instance, attentional mechanisms could be used to filter unimportant relations and thus bound the otherwise quadratic complexity of the number of considered pairwise relations.

## REFERENCES

- [1] McCulloch, W. S., & Pitts, W. (1943). A logical calculus of the ideas immanent in nervous activity. *The bulletin of mathematical biophysics*, 5(4), 115-133.
- [2] *Mathematica*, P. P. (1925). with AN Whitehead. Cambridge: Cambridge University Press, 7, 13.
- [3] Hebb, D. O. (1949). *The organization of behavior: A neurophysiological approach*.
- [4] Rosenblatt, F. (1958). The perceptron: a probabilistic model for information storage and organization in the brain. *Psychological review*, 65(6), 386.
- [5] Karp, R. M. (1992, August). On-line algorithms versus off-line algorithms: How much is it worth to know the future?. In *IFIP Congress (1)* (Vol. 12, pp. 416-429).
- [6] Minsky, M., Papert, S. A., & Bottou, L. (2017). *Perceptrons: An introduction to computational geometry*. MIT press.
- [7] Rumelhart, D. E., Hinton, G. E., & Williams, R. J. (1986). Learning representations by back-propagating errors. *nature*, 323(6088), 533.
- [8] LeCun, Y., & Bengio, Y. (1995). Convolutional networks for images, speech, and time series. *The handbook of brain theory and neural networks*, 3361(10), 1995.
- [9] Bottou, L., Cortes, C., Denker, J. S., Drucker, H., Guyon, I., Jackel, L. D., ... & Vapnik, V. (1994, October). Comparison of classifier methods: a case study in handwritten digit recognition.



- In Pattern Recognition, 1994. Vol. 2-Conference B: Computer Vision & Image Processing., Proceedings of the 12th IAPR International. Conference on (Vol. 2, pp. 77-82). IEEE.
- [10] Hinton, G. E., Osindero, S., & Teh, Y. W. (2006). A fast learning algorithm for deep belief nets. *Neural computation*, 18(7), 1527-1554.
- [11] Ian Goodfellow, Jean Pouget-Abadie, Mehdi Mirza, Bing Xu, David Warde-Farley, Sherjil Ozair, Aaron Courville, and Yoshua Bengio. 2014. Generative Adversarial Nets. In NIPS.
- [12] Cartwright, Mark, and Bryan Pardo. "SynthAssist: Querying an Audio Synthesizer by Vocal Imitation." NIME. 2014.
- [13] Mobin, Shariq, and Joan Bruna. "Voice Conversion using Convolutional Neural Networks." arXiv preprint arXiv:1610.08927 (2016).
- [14] Albelwi, S.; Mahmood, A. A Framework for Designing the Architectures of Deep Convolutional Neural Networks. *Entropy* 2017, 19, 242.
- [15] Elman, J.L., 1990. Finding structure in time. *Cognitive science*, 14(2), pp.179-211.
- [16] Klaus Greff; Rupesh Kumar Srivastava; Jan Koutník; Bas R. Steunebrink; Jürgen Schmidhuber (2015). "LSTM: A Search Space Odyssey". *IEEE Transactions on Neural Networks and Systems*. 28 (10): 2222. arXiv:1503.04069. doi:10.1109/TNNLS.2016.2582924
- [17] Danijar Hafner, Alex Irpan, James Davidson, Nicolas Heess, "Learning Hierarchical Information Flow with Recurrent Neural Modules", arXiv preprint arXiv: 1706.05744 9,(2017)
- [18] Noam Shazeer, Azalia Mirhoseini, Krzysztof Maziarz, Andy Davis, Quoc V. Lee, Geoffrey E. Hinton, Jeff Dean, "Outrageously Large Neural Networks: The Sparsely-Gated Mixture-of-Experts Layer", arXiv preprint arXiv: 1701.06538, (2017)
- [19] Sara Sabour, Nicholas Frosst, Geoffrey E Hinton, "Dynamic Routing Between Capsules", arXiv preprint arXiv: 1710.09829v2 (2017)
- [20] Günter Klambauer, Thomas Unterthiner, Andreas Mayr, and Sepp Hochreiter. Self-Normalizing Neural Networks, arXiv:1706.02515.
- [21] Jeffrey Pennington, Yasaman Bahri, " Geometry of Neural Network Loss Surfaces via Random Matrix Theory", Proceedings of the 34 th International Conference on Machine Learning, Sydney, Australia, PMLR 70, 2017.
- [22] Mnih & Kavukcuoglu & Silver et al., Human-level control through deep reinforcement learning, *Nature* 518, 529–533, (2015)
- [23] Hado van Hasselt, Arthur Guez, David Silver, " Deep Reinforcement Learning with Double Q-learning", arXiv:1509.06461 2016
- [24] Todd Hester, Matej Vecerik, Olivier Pietquin, Marc Lanctot, Tom Schaul, Bilal Piot, Dan Horgan, John Quan, Andrew Sendonaris, Gabriel Dulac-Arnold, Ian Osband, John Agapiou, Joel Z. Leibo, Audrunas Gruslys, " Learning from Demonstrations for Real World Reinforcement Learning", arXiv:1704.03732 (2017)
- [25] Nir Levine & et al., "Shallow Updates for Deep Reinforcement Learning", 31st Conference on Neural Information Processing Systems (NIPS 2017), Long Beach, CA, USA
- [26] Adam Santoro, David Raposo, David G. T. Barrett, Mateusz Malinowski, Razvan Pascanu, Peter Battaglia, Timothy Lillicrap, "A simple neural network module for relational reasoning", arXiv:1706.01427, (2017)

# The Role of Advanced ICTs in Effective CRM

M. Bakator\*, D. Radosav\*, N. Đalić\*\*, S. Stanisavljev, D. Milosavljev\*, E. Terek Stojanović\*

\* University of Novi Sad, Technical Faculty “Mihajlo Pupin“ Zrenjanin, Republic of Serbia

\*\* Faculty of Transport and Traffic Engineering, University of East Sarajevo, Republika Srpska  
e-mail: mihalj.bakator@uns.ac.rs

**Abstract** - The globalized markets have brought challenges to the majority of enterprises. Domestic enterprises lack in competitive ability due to low productivity and low product quality. The application of ICTs in various business processes has the potential to improve business performance and market positioning. ICTs in CRM systems can significantly improve customer retention rates and customer satisfaction. In this paper, the application of ICT-based solutions in CRM systems is discussed. The main goal of the paper is to develop a theoretical CRM model based on ICTs and to analyse the potential of such systems in domestic enterprises. The paper contributes to the existing body of literature and it provides a solid basis for future research.

**Keywords:** ICT application, CRM system, business performance, domestic enterprises.

## I. INTRODUCTION

The modern business environment characterized by the globalization of markets, the dynamic and rapid development of modern information-communication technologies (ICTs), and by the changes brought by the COVID-19 pandemic, brings challenges to enterprises when it comes to achieving a competitive and stable position on the market [1]. ICTs include a wide assortment of technologies that enable enterprises to store, obtain, analyse, and share data. This way enterprises increase their potential when it comes to business performance through increased productivity, improved decision-making, and an improved CRM system [2]. The application of ICT in management processes, especially in decision-making, has grown in importance due to the changes on the market that require flexible business strategies. The implementation process of modern ICTs has to be effectively addressed by managers as well other employees who will use it in their business tasks. This way the potential effectiveness of such implemented ICTs is increased [3].

Furthermore, when it comes to increasing business performance and achieving competitiveness the process of developing good customer relations has to be improved as customer retention is an imperative for business success. Solutions for CRM system improvement can be

found in the application of ICTs within these systems. CRM can be viewed as a strategic approach that utilizes various managerial and business tools, techniques, and methods with the goal to develop good relationships with customers through delivering value and increasing customer satisfaction. ICTs can significantly contribute to the effectiveness of modern CRM systems that are designed to adapt to the changing globalized market [4]. Modern ICTs provide the necessary infrastructure for fast-paced and even real-time customer support and customer evaluation (including customer behaviour, customer needs, and customer satisfaction). As modern markets are constantly fragmentizing and segmenting, and there is an increasing intensity of competitive relations between enterprises, CRM systems and the process of attracting and retaining customers are becoming the new status-quo, meaning that without modern ICT-supported CRM systems, enterprises have a slim chance at obtaining an adequate market position. CRM systems can increase operational as well as strategic performance and should be considered by enterprises accordingly [5]. However, the potential of such CRM systems can heavily depend on other external and internal factors as well. For example, competition intensity, market saturation, and regulatory clarity can significantly hinder the effectiveness of ICT application in enterprises. Similarly, internal factors such as employee skills, communication between managers and employees, and strategic focus on business goals can affect the outcome of ICT-based CRM systems.

In this paper, the important role of ICT implementation and application in modern CRM systems is analysed. The main goal of the paper is to present a theoretical CRM model that shows the potential of ICT application within CRM systems. The paper consists of four main sections (excluding the Introduction and Conclusion sections). The first section addresses advanced ICTs and their role in enterprises. The second section analyses the potential of CRM systems when it comes to

increasing business performance. Next, a theoretical model is developed to present the potential of ICT application within a CRM system. Finally, suggestions and guidelines for improving business performance of domestic enterprises are discussed.

## II. ADVANCED ICTS AND THEIR ROLE IN ENTERPRISES

The fourth industrial revolution - Industry 4.0 is characterised by the rapid development and application of advanced ICTs. Enterprises, and especially enterprises in developing countries, face challenges when it comes to conducting business within the framework of Industry 4.0. Advanced ICTs have the potential to increase enterprises' competitive ability and allow them to enter the globalized market. In addition, ICT application in enterprises can increase the diversification of products and services as well the creation of value for customers [6]. Modern ICT infrastructure can provide mechanisms that increase the number of opportunities, which the enterprise can seize. This can lead to increased growth and profitability. However, it is important to note that such positive outcomes from ICT implementation and application are not the default results, and in order to achieve such results, enterprises have to optimize and provide the necessary network, resources and employee skills into the ICT application process [7].

In practice, small and medium-sized enterprises are slower in the rate of ICT adoption compared to big enterprises and corporations. Beside the lack of infrastructure and resources, small and medium-sized enterprise owners have less trust in modern ICTs, especially when it comes to invoicing and scheduling. Therefore, small and medium-sized enterprises, in order to obtain competitiveness through ICT application, have to possess the necessary will and organizational approach towards organic improvements, which are ICT-based [8]. ICT solutions in an enterprise setting are often in the form of various information systems that can serve and support the marketing sector (marketing information system), decision-making processes (decision-making support system), financial sector (finance support systems) etc. Depending on the type of enterprise and the industry in which it conducts its business, information systems can address the quality management sector, sales sector, customer support sector [9]. Further, human resource information systems (HRIS) are another ICT solution that can bring significant improvement to managing employees. HRIS can improve processes when it comes to monitoring and

optimizing attendance, payroll, recruitment, training and assessment of conducted work [10].

ICTs can be implemented in a manner that it involves several business processes and sectors, thus providing an integrated system that can improve several aspects of conducting business at once. Integrated information systems can be viewed as solutions, which enable small and medium-sized enterprises to cut costs on infrastructure and network resources. Domestic enterprises in Serbia face challenges in the domain of quality, productivity, and application of modern management methods and techniques. Therefore, ICT-based solutions that require less resources is preferable, and often, the only approach the enterprise can take. In the modern business environment, market dynamics put pressure on enterprises in the process of attracting and retaining customers. Hence, effective CRM systems are becoming an imperative for developing strong and long-term relationships with customers.

It is evident that ICTs, and more specifically information systems, can find a large number of roles in an enterprise, depending on what business processes are to be improved. Industry in which an enterprise conducts its business also affects how an ICT-based solution will bring improvements to business performance. More precisely, ICT adoption in industries where such technologies are not represented in a high percentage could have a bigger potential compared to ICT adoption in industries where these modern technologies are widely used within the majority of enterprises. Further, for domestic enterprises in Serbia, due to the specific relations on the global market, ICT solutions should be market-oriented. This way customers could be attained effectively and retain rates could be increased.

## III. INCREASING BUSINESS PERFORMANCE THROUGH ICTS AND CRM

Considering the challenges of the modern business environment, creating value for customers is an important aspect of increasing business performance. Identifying what customers need and want represents an integral part of an effective CRM system. The application of ICTs within CRM systems creates a new CRM approach noted as e-CRM where customer relationships are developed through electronic media and the Internet [11]. Customer service and customer support are key elements of developing and maintaining good relationships with customers. E-CRM performance

is often affected by these factors as well as by interactivity, personalization, satisfaction and post-purchase support. E-CRM refers to a management approach towards marketing activities using ICTs, including information systems, and communication value through the Internet [12]. CRM systems that are based on ICTs rely on data collection and analysis. Depending on the timeframe of obtaining data, as well as on the type and volume of data, CRM levels can be analysed as current state indicators or as future insight and future trend indicators. This approach has tremendous potential when it comes to increasing market performance and overall business performance [13]. CRM systems are expected to be used in accordance with the enterprise's needs and business goals. Information is hyper-distributed on the globalized market and enterprises, especially domestic small and medium-sized enterprises, face difficulties and challenges on how to extract valuable and actionable information from data of such volume. Modern and advanced CRM systems that integrate ICT-based solutions possess the necessary mechanisms to obtain, store and analyse large volumes of data that results in valuable information. The enterprise can use this information to improve and optimize their marketing strategies, and increase the value that they offer to their customers or potential customers [14]. The use of modern CRM systems has been noted as an important aspect of business performance improvement. The main reason behind this is the development of stronger relationships with customers, compared to non-CRM supported relationships. As the digitalization rates of business and conducting business grew over the years, the application of CRM systems and the necessity for them also increased. These systems, in the modern, Internet-driven, and constantly changing market, present a significant technological contribution to how enterprises communicate and deliver value to their existing and potential customers.

CRM systems are focused on satisfying their customers and to, through such satisfaction, increase the rates of retention. The collected data from customer feedback and other sources (Internet and other electronic media), is analysed in order to quickly reduce its complexity and extract information that will identify and define what are the next steps that the enterprise should take [15]. Now, the noted CRM system is not guaranteeing increased business performance nor enhanced competitive ability. This is due to the complexity of effectively integrating and implementing such systems in almost any type of enterprise. Therefore

it necessary to take into consideration: the enterprise's needs; having sufficient resources; good communication between providers and employees at the enterprise; thorough preparation for the implementation process; preparing the enterprise before the system is used; providing support to managers; reorganization in the enterprise in accordance with the new system's requirements; and addressing the potential need for external consultants [16].

Overall, CRM systems based on ICTs have the potential to increase competitiveness and overall business performance. However, the implementation process has to be organic, and changes in the enterprise have to be long-term in order for the newly implemented CRM system to bring the best possible results.

#### IV. CRM MODEL BASED ON ICTS

Based on the analysed literature in the domain of ICTs and CRM systems, a theoretical model that presents an ICT-based CRM system is developed. The theoretical model is not created for a specific industry or enterprise, but it is rather generic in nature. The model is presented on Figure 1. The model consists of seven main elements that are described in more detail.

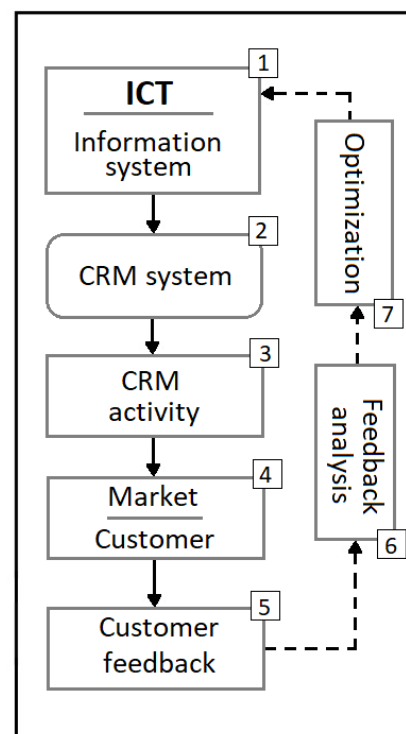

Figure 1. CRM model based on ICTs.

The first element of the model is an ICT-based solution that is applied within the CRM system. More precisely, an information system is used for

collecting, storing, and analysing data from the market. The CRM system is supported by the information system, and from here, specific activities are defined. The defined and outlined CRM activities are conducted on the market and mainly aimed at existing and potential customers. The integrated information system collects customer feedback data, which then is analysed in order to identify the level of customer satisfaction, potential future trends and overall market dynamics for a specific product, service, promotion, marketing campaign etc. After the feedback analysis, optimization is conducted and the cycle is repeated. This theoretical model includes a loop-like mechanism where customer feedback is evaluated and optimization regarding the CRM activities is conducted. This way continuous improvement can be realized in a timely manner.

Managers can make effective decisions, which result in better relationships with customers. This further translates into better business performance. For domestic enterprises, the noted ICT-based CRM system can be a significant tool in acquiring a competitive position on the globalized market. Namely, due to the rapid development of ICTs, the presented solution with customer feedback analysis is not expensive compared to larger infrastructures and complex ICT solutions. However, even though there is no need for large amount of resources for implementation and application, managers have to take into consideration the minimum required skills of employees that are needed for error-free CRM system application.

#### V. SUGGESTIONS AND GUIDELINES

Based on the analysed literature and the presented theoretical model, the following suggestions and guidelines for domestic enterprises, regarding CRM system application with ICTs, are noted:

- x Enterprises have to evaluate what aspects of business need improvement and which aspects lack behind the competition on the market;
- x After identifying issues in the enterprise, the most appropriate ICT solution and CRM system should be evaluated;
- x Based on the evaluation, the necessary resources for the implementation and application process should be accessed;

- x Enterprises should consider the best cost-to-potential improvement ratio when deciding which CRM system they implement;
- x The implemented system should be periodically evaluated in order to fix and improve underlying issues;
- x Customer relationship development should be an integral part of long-term business planning;
- x Communicating and delivering value to customers is an important part of achieving adequate market position and good business performance.

In sum, CRM systems are a significant part of conducting business in the modern business environment. Domestic enterprises have to consider an ICT-based CRM system, which has the potential to improve relationships with customers. This can further improve business performance and competitive ability.

#### VI. CONCLUSION

The fourth industrial revolution has brought tremendous changes on how business is conducted. The COVID-19 pandemic has put additional pressure on the majority of enterprises when it comes to achieving and maintaining adequate market positions. Developing strong and lasting relationships with customers is becoming an imperative for business success. Enterprises have to address the advantages of modern ICTs and their potential application in various business settings. CRM systems supported by such ICTs can significantly improve relations with existing and potential customers. The developed theoretical CRM model presents a simple overview on how ICTs can contribute to CRM systems through data/customer feedback analysis.

The main limitation of this paper is the lack of empirical analysis. However, it provides a concise overview and a solid basis for future research in this domain. For future research it is recommended to address enterprises directly, and conduct surveys on how they apply or plan to apply modern ICTs within their business processes. The processes should include CRM and other sectors as well. This way the interrelations between these sectors can be analysed.

**REFERENCES**

- [1] S. Mitić, J. Popović, J. Poštin, V. Čilerdžić, and L. Szabó, "Information technology as an indicator of the level of organizational performance", *Journal of Engineering Management and Competitiveness (JEMC)*, vol. 11, no. 1, 2021, pp.29-41.
- [2] H. Taştan, and F. Gönel, "ICT labor, software usage, and productivity: firm-level evidence from Turkey", *Journal of Productivity Analysis*, vol. 53, no. 2, 2020, pp. 265-285.
- [3] M. Abdullayev, "Analysis of application of information systems at industrial enterprises", *International Journal of Research in Social Sciences*, vol. 9, no. 6, 2020, pp. 138-152.
- [4] S. Chatterjee, R. Chaudhuri, D. Vrontis, A. Thrassou, and S.K.Ghosh, "ICT-enabled CRM system adoption: a dual Indian qualitative case study and conceptual framework development", *Journal of Asia Business Studies*, vol. 15, no. 2, 2021, pp. 257-277. <https://doi.org/10.1108/JABS-05-2020-0198>
- [5] M. Petrović, "Data quality in customer relationship management (CRM): Literature review", *Strategic Management*, vol. 25, no. 2, 2020, pp. 40-47.
- [6] A. Cataldo, G. Pino, and R. J. McQueen, "Size matters: the impact of combinations of ICT assets on the performance of Chilean micro, small and medium enterprises", *Information Technology for Development*, 2019, pp. 1–24. doi:10.1080/02681102.2019.1684870
- [7] T. Teniola Onileowo, and A. Ireti Fasiku, "The Concept and Application of ICT on SMEs performance in Nigeria: Limitation and Challenges", *E-Academia Journal*, vol. 10, no. 1, 2021. doi:10.24191/e-aj.v10i1.13353
- [8] J. Kowal, and G. Paliwoda-Pękosz, "ICT for Global Competitiveness and Economic Growth in Emerging Economies: Economic, Cultural, and Social Innovations for Human Capital in Transition Economies", *Information Systems Management*, vol. 34, no. 4, 2017, pp. 304–307. doi:10.1080/10580530.2017.1366215
- [9] O. Dynnyk, Y. Denysenko, V. Zaloga, O. Ivchenko, and T. Yashyna, "Information Support for the Quality Management System Assessment of Engineering Enterprises", *Advances in Design, Simulation and Manufacturing II. DSMIE 2019. Lecture Notes in Mechanical Engineering*. Springer, Cham, 2020. [https://doi.org/10.1007/978-3-030-22365-6\\_7](https://doi.org/10.1007/978-3-030-22365-6_7)
- [10] W. Baswardono, R. Cahyana, S. Rahayu, and M. R. Nashrulloh, "Design of human resource information system for micro small and medium enterprises", *Journal of Physics: Conference Series*, vol. 1402, no. 6, 2019, p. 066056. IOP Publishing.
- [11] C. Hendriyani, and B. Ruslan, "A Bibliometric: e-CRM Business Review", *KaPIN Conference*, 2021, pp. 213-222. Retrieved from <https://journal.kapin.org/index.php/conference/article/view/38>
- [12] N. Kampani, and D. Jhamb, "Analyzing the role of E-CRM in managing customer relations: A critical review of the literature", *J. Crit. Rev.*, vol. 7, no. 4, 2020, pp. 221-226.
- [13] A. Krizanova, L. Gajanova, and M. Nadanyiova "Design of a CRM Level and Performance Measurement Model", *Sustainability*, vol. 10, no. 7, 2018; p. 2567. <https://doi.org/10.3390/su10072567>
- [14] V. G. Navarro, R. O. Badenes, H. G. Gomez, and J. A. G. Gomez, "Customer relationship management (CRM): a bibliometric analysis," *International Journal of Services Operations and Informatics*, vol. 10, no. 3, 2020, p. 242. doi:10.1504/ijsoi.2020.108988
- [15] S. Chatterjee, S. K. Ghosh, R. Chaudhuri, and B. Nguyen, "Are CRM systems ready for AI integration? A conceptual framework of organizational readiness for effective AI-CRM integration", *The Bottom Line*, vol. 32, Nno. 2, 2019, pp. 144-157. <https://doi.org/10.1108/BL-02-2019-0069>
- [16] M. Cieciora, W. Bołkunow, P. Pietrzak, P. Gago, and M. Rzeźnik-Knotek, "Critical success factors of ERP/CRM implementation in SMES in Poland: pilot study", *Zeszyty Naukowe. Organizacja i Zarządzanie/Politechnika Śląska*. 148, 2020, pp 103-116.

# Electronic Application of Children for Enrollment in Preschool Institution

D. Banović\*, Z. Kazi\*

\*University of Novi Sad, Technical faculty “Mihajlo Pupin”, Zrenjanin, Republic of Serbia  
dragana.banovic@tfzr.rs; zoltan.kazi@tfzr.rs

**Abstract** – This paper describes a novel system for the electronic application of children for enrollment in preschool institutions in Serbia. The process of enrolment is described. System analyses and design are done through structural system analysis, data modeling, and object data model. Created models are implemented in PHP and JavaScript programming languages, MySQL relational database management system. Several web pages of a software solution and a part of various model diagrams are presented in this paper.

## I. INTRODUCTION

The development and application of information technologies in past decades have enabled organizations and institutions flexibility and adaptability during working and functioning. Many business problems were solved by automating and reducing the number of business activities. The use of information systems is imperative in systems, enterprises, businesses or education institutions because they enable collecting, memorizing, and organizing a huge amount of data, processing information, and in the end generating various reports and analyses for a decision support role.

Information systems are also extremely important in educational institutions. A well-structured information system in the education area enables more thorough planning and implementation of the different educational processes.

The topic of this paper deals with the information system for enrolling children in preschool. This problem is elaborated through system description, structural system analysis, data modeling, object data modeling and programming software. An object-oriented approach was used within the software implementation. The paradigm of the object-oriented approach is to look at the real world as an organized set of objects that have an established state and behavior, that are in mutual interaction and the goal of that interaction is to achieve predetermined goals.

The rest of the paper is organized in the following sections: the second heading describes the business process, the third heading presents the conceptual design of the web information system, the fourth is

the technical description and the last section is a conclusion.

## II. ENROLLMENT BUSINESS PROCESS

At the beginning of the new year, the Ministry of Education sends a letter to the preschool institution containing a budget quota and a list of priorities. Based on that, the preschool institution makes a decision that contains data on the number of vacancies following the available capacities of the kindergartens and the budget quota of the ministry. The accounting department prepares a price calculation. The formed prices must be forwarded to the parents.

At the end of March each year, the kindergarten announces a competition. Parents register their children by filling out an online form. The form contains basic information about the children, parents (or guardians), their social and family status, i.e. whether they belong to a socially vulnerable group, and to which group they belong. Also, parents are obliged to state the child's health condition in the application.

At the end of the competition, a list of children's priorities for enrollment is formed and it is based on data submitted by parents and the number of vacancies. Priority for enrollment is given to children from socially vulnerable groups: children victims of domestic violence, children from families that use some form of social protection, children of single parents, children from socially unstimulating backgrounds, children of seriously ill parents, children whose parents are war invalids, children proposed by the Center for Social Work; children at risk: e.g. asthma, heart murmur, etc.

The kindergarten issues a certificate of child enrollment to the parents. The preschool institution, under the Law on Preschool Education is obliged to enter data in the registry book of the enrolled children. Personal data about children and their parents, ie guardians, are entered in the children's register. Data on preschoolers are forwarded to educators. When all these tasks are completed, the

preschool institution sends a report to the ministry about the number of enrolled preschoolers.

The enrollment of children in a preschool institution is done under the Law on Preschool Education, which states the goals of preschool education that each preschool institution endeavors to achieve. The preschool institution, following its capabilities and the expressed needs of families for various preschool education programs, at the request of parents or guardians, enrolls preschool children, according to the criteria for determining priorities for enrollment.

Currently, in Serbia, there are only a few preschool institutions that make an online enrollment application, but there are still those that enroll children based on the personal departure of parents to the institution. This is a burden for the administrative part of the preschool institution. The online application makes the procedure easier for parents who do not have flexible working hours, but also is a benefit for the administration of the preschool institution.

In the last few years there is a growing need for this kind of application and usage of information systems, databases, and information technologies, so most preschool and other educational institutions need this way of working.

### III. SYSTEM ANALYSES AND DESIGN

Analyses of the business processes from the description and insights into the application documents, following business processes are identified in this early phase of system analyses:

- Preparation of the competition: deciding on the competition, budget quota records, making a price calculation, priority list records.
- Candidate application: announcement of the competition, records of received forms.
- Candidate enrollment: creating a ranking list, supplement the registry book with data on preschoolers, update the registry book with information about the parents, issuance of a certificate of enrollment, sending a report to the ministry, processing of data on preschoolers.

The business processes model diagram with entities, data flows, processes and data stores that exist in this area is shown in “Fig. 1”.

The conceptual data model was done with a case tool. A diagram of this model is presented in “Fig. 2”. It contains entities with attributes and their domains, data types, constraints, relationships

between entities [1]. Some of these objects are imported from the business processes model.

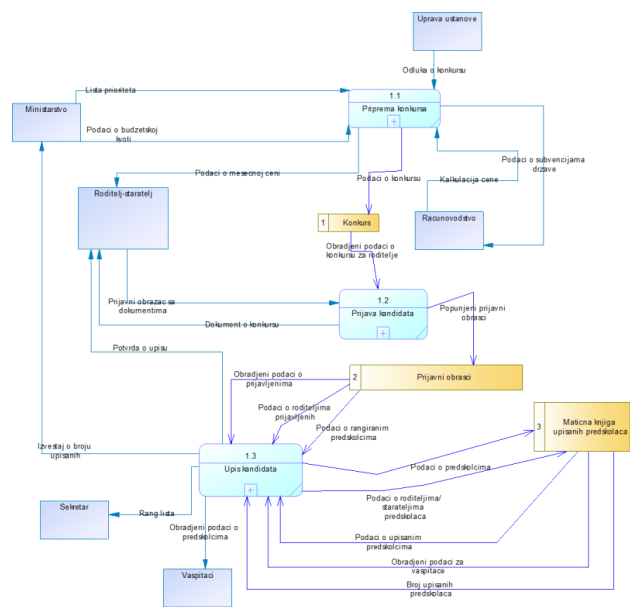

Figure 1. Business process model diagram

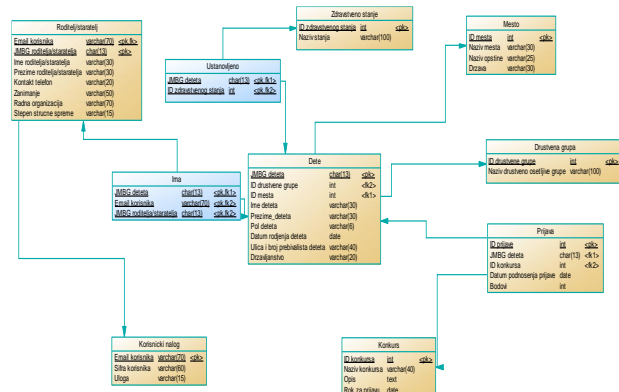

Figure 2. Conceptual data model diagram

### IV. SYSTEM DESCRIPTION

When starting the home page, there are the following functions: child's log in, a contest preview where the contest can be selected from the drop-down menu, login and user registration. On the home page there is also an "advertisement" for the registration of children which displays a message to the user on how to log in and how to register the child. There is also information about the application. User login requires entering the user's email address and password and the ability to register if the user has not created a user account. The parent registration form has been implemented in the same way. It is shown in “Fig. 3”. When registering a user-parent, the user's code is also filled in, and in addition, data of the parent, such as name, surname, identity number, etc. A parent



cannot create an account unless they enter their personal information. All registered users are considered parents, while the administrator is entered directly into the database in the user account

The image shows a mobile application registration form. The form is titled "Registracija" and is displayed in a white box over a background image of children. The form is divided into two main sections: "Nalog" (Account) and "Podaci roditelja" (Parent Data). The "Nalog" section includes fields for "Email" and "Šifra" (Password). The "Podaci roditelja" section includes fields for "Ime" (Name), "Prezime" (Surname), "JMBG" (Municipality Identification Number), "Telefon" (Phone), "Zanimanje" (Interest), "Radna organizacija" (Work Organization), and "Stepen stručne spreme" (Level of Education). A blue button at the bottom of the form is labeled "Registruj nalog" (Register account).

Figure 3. User registration form

table without the need to register.

The main menu is created based on a usage of a case diagrams [1] that distinguishes two types of users: parents and system administrators.

User account information edit is available to any user profile (both administrator and parent) after the successful login. The change is made on a page with a form that displays data of the current user. The email address is unique, so the user cannot select an address that already exists in the database.

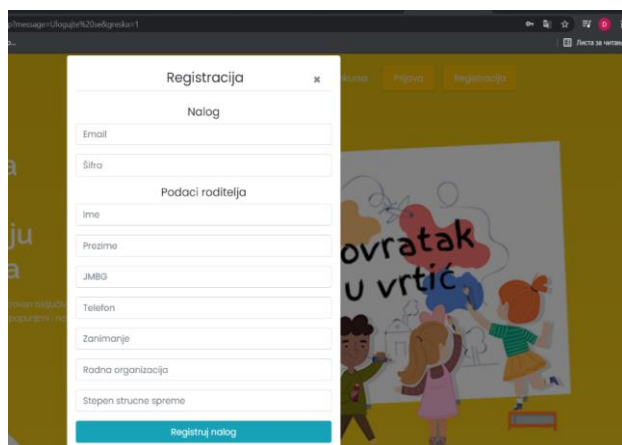
Only users who are registered as parents can register a child. As it can be seen in "Fig. 4" the application form consists of filling the personal data about the child, such as e.g. name, surname, address, etc., and in the choice of the social group to which the child belongs - whether he belongs to a socially sensitive group or not, and what the child's health condition is. Data on the socially sensitive group or endangered health condition of the child are priorities when ranking, because based on that, these children receive points. If a parent chooses that the child is in good health, he loses the opportunity to choose a health problem, the same is true for a social group. After selecting the "apply" button, the child is entered into the database and a confirmation of the success is sent to the user. It is important to mention that parents cannot apply for a child for a competition that has expired, ie whose deadline has passed.

The basic data in the system are: places, health conditions, social groups and competitions. This

information is entered by the administrator via input web forms. This page is available only to the administrator. After completion of data entry, a user

The image shows a web application form titled "Prijava deteta" (Child Registration). The form is displayed in a browser window. It includes fields for "Lokacija" (Location), "Šifra" (Password), "JMBG" (Municipality Identification Number), "Datum rođenja" (Date of Birth) with a calendar icon, "Mesto (Zemljopis)" (Place (Geographical)), "Prva nastava" (First Lesson), "Spol" (Gender) with radio buttons for "Muško" (Male) and "Žensko" (Female), "Ne pripada društveno ugroženoj grupi" (Does not belong to a socially vulnerable group) with a checked checkbox, "Dobrog zdravstvenog stanja" (Good health condition) with a checked checkbox, and "Mesto ŽSK" (Municipality). A green button at the bottom is labeled "PRIJAVA" (SUBMIT).

Figure 4. Web application form

receives a message whether data has been successfully entered into the database.

The search of data was realized using the JavaScript function [2]. Users must enter part of the name or full name in the search field. The function allows data from all columns to be a search criteria. For example, we can enter the Republic of Serbia and it will show all the places that are in the country or type in the name of the place or the identification number of the place. There is also a software function that allows you to view all data. When the desired data is found or all data function is selected, a table appears which, in addition to data, also contains the option to edit and delete entered data. If a user wants to delete data, a confirmation message appears stating whether users are sure or not to delete data after confirmation. After confirmation data will be deleted from the database with a message about the successful operation.

Within the web application, there is a possibility for creating two types of reports: a report on the applicants for the competition with points and a report on the registered child ("Fig. 5"). Only the administrator has access to these reports. They can be printed on paper or saved in PDF file form. If users want to generate a report on the registered children, it is necessary to choose the competition. If a report is needed for a specific child, it is necessary to enter the Personal ID number of that child. In addition to personal data, the report on the child also contains data on the social group and health condition.

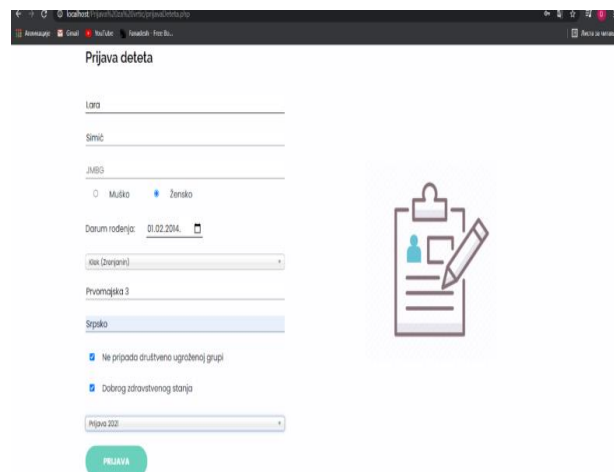
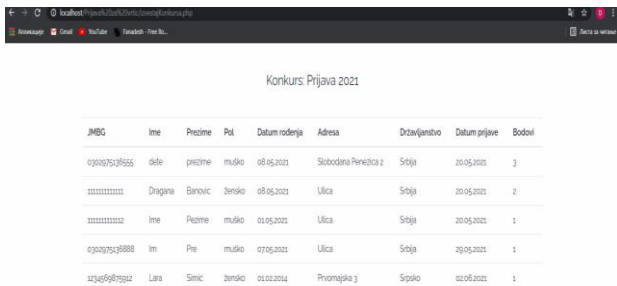

JMBG	Ime	Prezime	Pol	Datum rođenja	Adresa	Društvo	Datum prijave	Bodovi
030079319555	dele	prezime	muško	08.05.2021	Stobodara Penećica 2	Štija	20.05.2021	3
030079319555	Dragana	Barović	žensko	08.05.2021	Ulica	Štija	20.05.2021	2
030079319555	Ime	Prezime	muško	01.05.2021	Ulica	Štija	20.05.2021	1
030079319555	Im	Pre	muško	07.05.2021	Ulica	Štija	20.05.2021	1
030079319555	Lara	Simić	žensko	01.02.2014	Prinospiška 3	Siplo	02.05.2021	1

Figure 5. Report preview

## V. IMPLEMENTATION

This application is implemented with an object-oriented approach, which involves working with classes, objects, attributes and methods. Attributes are created based on the columns of the database table, and the methods are used for implementation. They are constructed upon previous models [1]

The content of the home page is formed by the Bootstrap framework [3], using the section classes in the central part of the page. The site consists of HTML tags and links to CSS and JavaScript files [2]. The character set is UTF-8, which is the most suitable variant for encoding Latin text. PHP commands, shown in “Fig. 6”, are embedded within HTML tags and they are used to turn on the top and bottom menus of the page with the include command, as well as to print a message to a user who retrieves data by the GET method from a URL [4]. If the user does something that is recognized as an error, the message will be printed in red, as opposed to green, and this is done using the JavaScript function and the color-changing CSS class [2]. A session has also been started within the PHP command [4].

User login consists of transferring data between pages using the POST method, but only if a session is started. Within the classes, data is retrieved using the SELECT SQL command. After that, it is checked whether one data has been returned and if it is not, it means that there is no account with the given email and the received data is passed through. Then it is checked if the code is good and if so, data is assigned to the session. The page also displays a link to the registration page if the user does not have an account.

User registration is done similarly as login except that a parent class object is created, since it is necessary to enter in the database both in the parent table and in the account table, because the parent cannot register if he has not entered personal data.

Logging out of the user account consists of commands to start and destroy the session and then a message to the user stating that they have successfully logged out.

Modifying a user account is available to both parents and administrators. The user can change the account if the session contains an email, i.e. the user must be logged in. An account class object is created. The POST method downloads data entered in the modification form and calls the modify e-mail and edit e-mail with a password, depending on whether the user wants to change the password as well. After the change, a new modified email is assigned to the session.

Only the administrator can enter basic data. The entry is made by creating an object of a given class, then the POST method sends data from the form and calls the method of the class that is used to record data. It is important to mention that the deadline for applications cannot be chosen for the competition.

Displaying data part calls a class method that uses the SELECT SQL command from a table to retrieve all data from the database. PHP function `mysqli_num_rows` shows how much data is in the table and if it is greater than zero the while loop is passed through that data and it is written to the HTML table during the web page creation.

Data search is implemented by calling the PHP method while opening the page, which will download all data and place it in a table, and with the help of JavaScript functions, that table will be displayed with all or filtered data.

Within data search pages, there are also options for deleting and editing data. For these operations the GET method was used to retrieve the identification number from the URL. For editing data we used the SQL DML UPDATE command. Deleting selected data from the database was done with the DELETE SQL DML command. Before deleting, the user is shown a message whether he is sure he wants to delete the selected data. After these executed orders, users receive a message about their success.

An object was created within the page for displaying the competition. Using the drop-down list created for competitions loading from the relational database with the SELECT SQL DML command. The user selects the contest he wants to review. It is retrieved from the URL by the GET method id of that contest. Using the if statement, it is checked whether the deadline for applying for the competition has passed for that competition, it will

be printed that it has expired. If the application deadline has not expired, the competition data will be displayed.

The basic business process that is implemented is the registration of the child. This can only be done by registered users who are registered as parents. Due to data that are filled in different tables, class objects were created: Child, Parent, Place, Health status, Social group, Competition and Application. Using the POST method, data is retrieved from the form. Before recording this data and calling the appropriate method, it is checked if the child's identity number already exists in the database. If there is, a message is printed to the user. After the identity number is checked, the methods for saving data into the tables are called. These methods are implemented within classes and use the SQL DML INSERT command. Data are also recorded in the link tables using the Parent-Link and Health link methods, as the relationship is higher to higher.

```
if(isset($_POST['sacuvaj']))
{
    $ime=$_POST['ime'];
    $prezime=$_POST['prezime'];
    $jmg=$_POST['jmg'];
    $ost=$_POST['ost'];
    $datumodjenja=$_POST['datumodjenja'];
    $mesto=$_POST['mesto'];
    $adresa=$_POST['adresa'];
    $drzavljanstvo=$_POST['drzavljanstvo'];
    $drzavstvenastanjanje=$_POST['drzavstvenastanjanje'];
    $drzavstvenigrupa=$_POST['drzavstvenigrupa'];
    $stokura=$_POST['stokura'];

    if(!$roditelj=$proveri306($jmg))
    {
        echo"<script>location.href = 'prijavideteta.php?message=306+već+koristiš+greska=1';</script>";
        exit();
    }
    if(!$dete=$proveri306($jmg))
    {
        echo"<script>location.href = 'prijavideteta.php?message=306+već+koristiš+greska=1';</script>";
        exit();
    }

    $socialjendete=$dete=$siniadete($jmg,$ime,$prezime,$pol,$datumodjenja,$adresa,$drzavljanstvo,$drzavstvenigrupa,$mesto);
    if($socialjendete)
    {
        echo"<script>location.href = 'prijavideteta.php?message=došlo+je+do+greške,+dete+nije+siniadete+greska=1';</script>";
        exit();
    }

    $detemoditelj=$dete=$poveziSaboditelj($jmg,$SESSION['jmg'],$SESSION['email']);
    if($detemoditelj)
    {
        echo"<script>location.href = 'prijavideteta.php?message=došlo+je+do+greške,+dete+roditelj+nije+povezao+greska=1';</script>";
        exit();
    }
}
```

Figure 6. PHP programming language commands

Reports are created on several web pages. On this pages for report generation objects of the application class and the competition class are created to take data on the names of the competition and data on the applicants. The downloaded data is printed in the HTML table form if the methods return a result greater than zero for a number of loaded rows from database tables, otherwise it is printed that there are

no applications for the selected competition, ie the table in the database is empty. Within the child report page, PHP first calls the method that checks if the entered personal identification number exists in the database. If it does not exist, a message is displayed to the user. Then, when the personal identification number was taken over by the POST method, data on the child from the table Child, data on the health condition from the table Health condition and divisions about the social group from the table Social group are loaded. The obtained data are gattered into the HTML table in the report.

## VI. CONCLUSION

Within this paper, the most important function of preschool institutions, child registration has been presented. In this novel software, the child's application is designed to be done online and the application is filled in by the parents. In that way, the administration of the institution facilitates the procedures, and thus saves time for both them and the parents. The software has an important function for automatically assigning points to registered candidates based on the given criteria, which simplifies the ranking procedure. The main advantage of web applications is their independence from the type of computer, operating system or platform, so it is available to all users.

Knowledge of CASE tools, databases, three-layer architecture, object-oriented programming and languages CSS, HTML, PHP and JavaScript was required for the preparation of the paper.

The possibility of upgrading the software is provided by the structural system analysis, which contains other tasks performed during the enrollment of children, such as calculating the price, opening the child's registry, issuing a certificate of enrollment, sending reports to the ministry and the like.

## REFERENCES

- [1] B. Radulović, Lj. Kazi, and Z. Kazi, "Information Systems" (on Serbian), University of Novi Sad, Technical faculty „Mihajlo Pupin“, Zrenjanin, 2011.
- [2] J.C. Meloni, "Sams Teach Yourself HTML, CSS and JavaScript", SAMS, Pearson education, 2012.
- [3] F. Cimo, "Bootstrap Programming Cookbook", Exelixis Media, 2015.
- [4] K. Tatroe, P. MacIntyre, R. Lerdorf, "Programming PHP", 3rd edition, O'Reilly, 2013.

# The Use of Web Tools 2.0 in Education

T. Milić\*, I. Berković\*, E. Brtko\*, I. Vecštejn\*, K. Ivanović\*

\* University of Novi Sad, Tehnical Faculty „Mihajlo Pupin“, Zrenjanin, Serbia  
tamaraaamilic021@gmail.com, ivana.berkovic62@gmail.com, eleonorabrtka@gmail.com,  
igor.vecstejn@gmail.com, katarina.ivanovic@tfzr.rs

**Abstract – Web 2.0 tools are often used in education, in industry, in every place where people apply IT knowledge. The paper shows how web tools advanced over span of years, what applications are people using for productivity, education, etc. There are several categories of applications that people mostly use in their life. Discription and purpose is given to every application.**

## I. INTRODUCTION

This century has brought big changes and revolution into the world of technology. The big change was caused by the introduction of the Internet at the beginning of the sixties in the previous century and technologies in education gained immense popularity by an increasing access and use. From that moment till today, technology has been present in all branches of education. People replaced traditional learning with contemporary learning, actually, people would rather choose to learn from digital devices than from the books. The combinations of technologies in education are innumerable. The use of technology in education provides advantages for students' learning. These advantages are: flexibility, large selection of tools, free access to the programme, free and wide scope of learning websites, motivation, etc. There are 4.72 billions of Internet users in the world currently [1]. Majority of them tried to learn via the Internet at least once.

Due to the big revolution of technologies, teachers are expected to improve and apply ICT in education. Immense advantage of the teaching improvement lies in the fact that teachers have access to a wide range of programmes and tools. Web tools 2.0 are one of them. By using this type of tool, a teacher is enabled to create attractive material that will motivate students to learn more easily and accept this learning approach. The only problem is the fact that there are numerous useless tools, which are not very applicable and do not have the future, on the Internet. For this reason, it is very important to make the right decision which tools to use out of the available ones.

## II. HISTORY OF THE WEB

World Wide Web is a system containing hypertext documents which are accessible via the Internet [2]. Using a Web browser, a user is enabled to search Web pages which can contain text, pictures, videos, etc. Web tools 1.0 first appeared in 1989. They were defined as a network of information links. Innovator of WWW, Tim Berners-Lee, considered the Web as 'read-only' [3]. Such a type of the Web offers a little interaction, a user can download the information, but a user cannot interact with the Web page.

Web 2.0 is the second generation of the Web. It was defined by Dale Dougherty in 2004 as 'read-write' [3]. The term became popular after the conference held by O'Reilly Media in 2004. Tim O'Reilly defined Web 2.0 as a business revolution in IT industry. The revolution was caused by the transfer of the Internet to the platform and an endeavor to understand the success rules on the new platform [4]. Web 2.0 enables the main features, such as participative, collaborative and distributive practice which enable formal and informal spheres of everyday activities by using the Internet [5].

Web 2.0 is in the form of a platform whose users have significantly bigger interaction in comparison to the previous version, which can be seen on the picture 1. Web 2.0 is not only a newer version of the Web 1.0, but it also involves a better, more modern and more flexible design, it contains updates, content creation, as well as its modification. On Figure 1. there is comparison of Web 1.0 and Web 2.0.

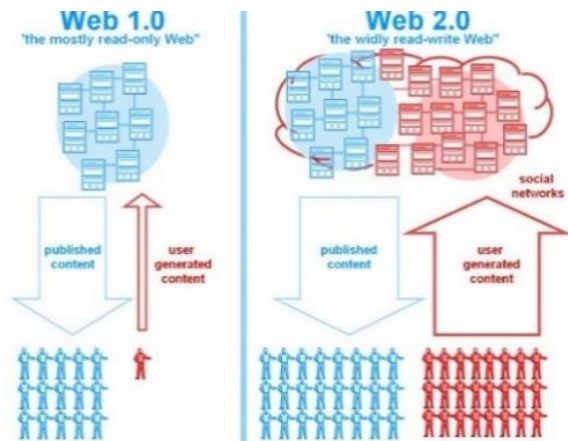

Figure 1. Comparison of the Web 1.0 and Web 2.0 [6]

### III. WEB TOOLS 2.0

Traditional methods frequently do not raise students' interest for the class, do not maintain the motivation and their active participation. Web tools 2.0 are considered to be very significant for eliminating this type of shortcoming. Web 2.0 is established as the Web application which enables users to create content in the Web environment, which provided students with a kind of an advantage, such as online discussions and various sorts of electronic communications [7].

Some advantages of the Web tools 2.0 use are: accessibility of electronic materials which are available on the Internet, possibility of learning in groups, the use of various tools and programmes. Many of these tools are free of charge and available to everyone. By using the Web tools, a teacher can monitor all students' activities. Besides the possibility to use the teaching content received from the teacher, students have possibility to upload their materials on the Web, communicate, acquire additional ICT skills, work together on certain homework, projects, etc.

### IV. FEATURES OF WEB TOOLS 2.0

Besides the above-mentioned advantages of Web tools 2.0 within the previous subtitle, it is necessary to mention the disadvantages as well. Some of the disadvantages are: issues with the Internet, the accuracy of information online, user's privacy at the time of access to the information, etc. The Web can be imagined as a huge library of documents that have their specific place, they are interrelated by links and the users can freely move around that library, add comments on public documents, exchange comments with other users, add new files by themselves, etc. [8]. Web tools 2.0 have open source interface, they are configured according to the users' request, they offer the possibility of multimedia content transfer, they

contain options for uploading, downloading, converting and deleting of the files.

### V. CLASSIFICATION OF WEB TOOLS 2.0

Web tools 2.0 can be classified into several types:

- Tools for annotation and collection of the Internet content
- Tools for knowledge assessment and questionnaire creation
- Tools for planning and organization
- Tools for social connecting and virtual communities
- Tools for the creation of teaching content presentation
- Tools for online education system

Due to their multiple functionality, many Web tools can be classified into several categories. The most frequently used Web tools 2.0 are classified into the following categories:

- Communication
- Collaboration
- Multimedia
- Interactive teaching games
- Quizzes, Questionnaires
- Communities
- Blogs

### VI. LIST OF WEB TOOLS 2.0 MOST FREQUENTLY USED IN EDUCATION

Specific Web tools can be classified into various above-mentioned categories, based on different criteria, but one thing in common for all of them is that they are free of charge. For each of the previously mentioned categories, one tool is going to be mentioned.

#### A. Annotation and collection of the Internet content - Diigo

This Web collector presented on the Figure 2 is best described as a group of tools for knowledge management. Diigo is a complex tool which is used for the collection, sorting, archiving and sharing of different Web contents.

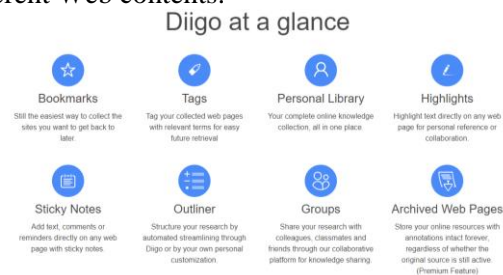

Figure 2. Diigo Web collector

*B. Knowledge assessment and questionnaires – Kahoot*

Kahoot, presented on Figure 3, is a free Web tool used for the creation of interactive questionnaires which can be used in the process of teaching. It can be said that Kahoot is a platform based on games, it is possible to create quizzes via it, share with other users, play games which are made for learning or do trivial quizzes.

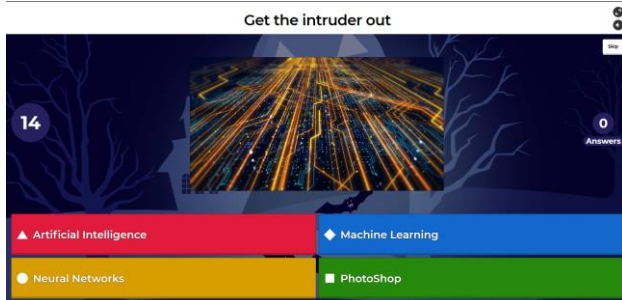

Figure 3. Kahoot platform

*C. Planning and organization - Linoit*

Notebooks, planners, reminders, timetables, calendars, sticky notes on desks, fridges and cabinets were use for planning personal, school or business obligations. Nowadays, for all of the listed, there are Web tools intended for the organization of assignments in terms of calendars, planners, schedules, etc. One of the tools with this purpose is Linoit. Linoit is a tool in the form of a 'sticky' board that stickers and other files are attached to. An example of this tool can be seen on Figure 4. It is very simple to use, large number of users are using it, there are no limitations regarding the type of files.

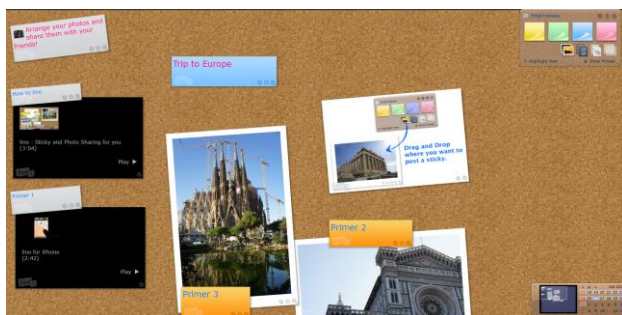

Figure 4. Presentation of Linoit tool

*D. Social connecting and virtual communities – Social networks*

Social networks enable users to exchange photos and videos, post their thoughts in written form and conduct questionnaires through their personalized pages of a user's profile. Students can use them for content sharing, giving feedback and support when solving issues [9].

Social networks and virtual communities are divided into several groups according to different criteria:

- Global: These are social networks accessible to everyone. Twitter, Facebook, LinkedIn, Instagram are, although having differences among themselves, intended for everyone.
- Special social networks: These are intended for certain groups of people connected by shared professions or interests.
- Learning platforms: These are platforms used for learning, such as: Edmodo, Piazza, Sofia, Ecto, etc.

*E. Presentation of teaching content – Prezi*

Prezi is a programme intended for the creation of presentations that have different look and purposes in all branches. Some of the purposes can be seen on Figure 5. In education, this tool contains special learning styles and knowledge construction, it is possible to include multimedia in it, to share them on the network and present online, as well as offline.



Figure 5. Presentation of Prezi software [10]

*F. Online systems for education – Office 365*

All of the above-mentioned services are developed by leading ICT companies as a unique system of services for online business, as well as education. These systems include a set of applications for the companies which can satisfy their needs for electronic communication in the company and with their clients, for team projects, promotions, etc. Microsoft has an entirely new and improved system for education, named Office 365. It connects all of their services: e-mail, digital documents such as Word, Excel, calendar, Skype for business and many others. Group of applications in Office 365 is presented on Figure 6.

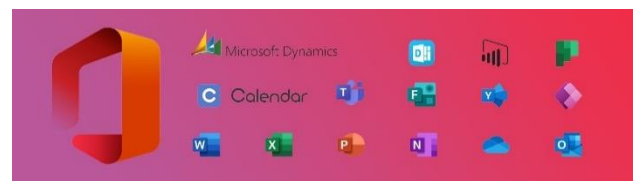

Figure 6. Presentation of Office 365 application [11]

### G. Online 'classrooms' for learning – Google Classroom

Google Classroom, presented on Figure 7, is an application free of charge, actually, it is a platform for distance learning. This platform offers a possibility for teachers to create a virtual classroom (space) so that they could communicate with their students, share materials in different forms, post textual notifications, links, assignments, tests and evaluate students' activities. Google Classroom relies, to a great extent, on other Google tools, for example: Google Docs – used as a substitute for Microsoft Word; Google Sheets – substitute for Microsoft Excel; Google Drive – Google disc, used for storage of documents, files, etc; Gmail – used for communication; Google Forms – used for the creation of tests, assignments, quizzes; Google Meet – used for communication of two or more users, etc.



Figure 7. Presentation of Google Classroom

## VII. THE USE OF WEB TOOLS IN TEACHING

During the pandemic, educational institutions had to exert additional effort in order to provide their pupils and students with adequate teaching. Teachers and professors put a lot of time and effort so that they could innovate their teaching, create new materials, use new methodologies, etc. This period has not been easy for pupils and students, as well. Besides all the materials and obligations they had on certain courses, they were obliged to learn new methodologies and various digital tools in order to follow classes without any issues. At Technical Faculty 'Mihajlo Pupin', which I am currently attending, professors and teaching assistants put a lot of effort in order to present learning contents from different courses that their students needed to learn. We used Google classroom, as a virtual classroom, in which materials in the form of PowerPoint presentations, PDF documents, .docx documents, video materials and various links were regularly posted by the professors. Students' participation during classes and points acquired at

tests were calculated via Google Forms or Kahoot and updated in the chart of the classroom. Classes were held in the form of video communication via Google Meet. Apart from video calls, Google Classroom provides an option of a shared screen, so each of the students had an opportunity to hold presentations or present projects that needed to be done within certain courses.

## VIII. CONCLUSION

Newer approaches to teaching are being increasingly used. It is really challenging to maintain teachers', as well as students' motivation. In order to be able to use new technologies, teachers are required to adopt lifelong learning so that they could use and implement these technologies into their teaching process. Besides learning new technologies, professors need to develop a form of creativity, problem solving skills in order to draw students' attention. Students of the XXI century require new technologies, teaching that takes their habits and interests into consideration, this is considered as a must. This is an era in which professors, as well as students, are required to adopt lifelong learning process.

## ACKNOWLEDGEMENT

This research is financially supported by Ministry of Education and Science of the Republic of Serbia under the project number TR32044 „The development of software tools for business process analysis and improvement“, 2011-2021.

## REFERENCES

- [1] Webiste: <https://datareportal.com/global-digital-overview>
- [2] W3C, "World Wide Web Consortium", Website: <https://www.w3.org/>
- [3] Tim Berners-Lee, "The World Wide Web: A very short personal history", 1998
- [4] Andrew McAfee "Enterprise 2.0 New Collaborative Tools for Your Organization's Toughest Challenges", 2009
- [5] P.Kujur, B. Chhetri "Evolution of World Wide Web: Journey From Web 1.0 to Web 4.0", IJCST, 2015, pp. 134-138
- [6] Website: <https://balqisnadiyah.wordpress.com/2016/05/14/web-1-0-vs-web-2-0-vs-web-3-0/>
- [7] F. Cumhur, S.S. Cam „Digital transformation in assessment and evaluation course: The effects of Web 2.0 tools“, Journal of Pedagogical Research, 2021, pp. 15-39
- [8] J. Maness „Library 2.0 Theory: Web 2.0 and Its Implications for Librarians, Webology“, 2006
- [9] M. Bower, J. Torrington "Typology of Free Web-based Learning Technologies", 2020
- [10] Website: <https://prezibase.com/free-prezi-templates/>
- [11] Website: <https://blog.superfast-it.com/office-365-list-applications-uses>

# Virtual Reality Technologies Usage in the Area of Management and Therapy of Phobias and Cognitive Abilities

B. Sobota<sup>\*</sup>, P. Lovas<sup>\*</sup>, Š. Korečko<sup>\*</sup>, M. Mattová<sup>\*</sup>

<sup>\*</sup> Department of Computers and Informatics, Faculty of Electrical Engineering and Informatics, Technical University of Košice, Slovak Republic

branislav.sobota@tuke.sk, patrik.lovas@tuke.sk, stefan.korecko@tuke.sk, miriama.mattová@tuke.sk

**Abstract** – This paper describe a designed and implemented system for managing phobia. The system provides three testing modes with the option to change a model. In addition, the system also allows the management of subjects and the tracking of the history of individual therapies. The system also supports the live video stream from HoloLens to therapist's computer with automatic saving. The whole solution is based on the Unity platform using Microsoft HoloLens. This is used to display models in augmented reality. The solution was tested by a group of ten subjects. The testing was aimed at verifying the functionality of the proposed system. Testing confirmed the functionality of the system as well as the variability of measurement results. In addition to direct testing of the system, a questionnaire was submitted to subjects to obtain their subjective opinion of working in such a system. A questionnaire was confirmed that subjects would use this system and they perceive it as easy to use.

**Keywords:** phobia, virtual reality, augmented reality, Microsoft HoloLens, therapy

## I. INTRODUCTION

Cognitive abilities allow performing judgments related to direction and distance among external objects and thus make individuals able to navigate in an environment [1] – in a real or virtual one. Thanks to these functions, we are able to detect, represent, manipulate and store visual and spatial information [2]. For humans, this also means the ability to perceive visual objects, locate their position in space, focus the attention, infer various spatial relations and remember a scene [3].

However, every year it is possible to see more people talking about mental health problems. Especially problems such as depression, anxiety or phobias are no longer considered to be fictitious diseases, but are perceived by the public as a real problem. Phobias are usually treated or alleviated in two ways. It is a *cognitive-behavioral method* or the *exposure method* [4]. A virtual reality can be used to improve these techniques. From the current point of view, the use of XR (eXtended Reality, i.e. the use of a com-

bination of VR (Virtual Reality), AR (Augmented Reality) and MR (Mixed Reality) ) as an integrating application platform, may represent an interesting way of both hardware and software development in this area in the future.

## II. RELATED WORKS

Testing and training of cognitive functions in virtual reality (VR) is an important development in the effort to widen the knowledge of human mind. VR represents one of the most promising branches of the technology industry. One of the activities, contributing to this effort, is an experiment that is being carried out at the LIRKIS laboratory of the home institution of the authors. The experiment evaluates how the peripheral perception of objects and detection of changes in their position and state can be improved by a VR experience. This experiment was performed in the environment of virtual cave LIRKIS CAVE using like Tower defense game for testing [5]. Base on this was developed also branch solution for management and therapy of phobias and cognitive abilities using MS Hololens VR headset. The targets (a distractors were not implemented yet) in the game can represent the phobia objects. The short description of this solution is in the rest of this paper.

Very usable technique is called VRET [6][7]. VRET allows patient to communicate with the digital world, where are the same fears which cause anxiety to the patient in normal life. With VRET they can face them and overcome these fears of phobia in a safe and controlled environment [8]. Many experts see the benefits of using VRET. According to McGonigal [9], up to 20.5% of therapists believe that the system can have great potential for improving anxiety disorders. The advantage of VRET is also the diversity of the environment and objects that we can display to the patient. This allows us to cover



a large set of phobias for which this therapy can be used.

In addition to the advantages VRET has also disadvantages. The two main disadvantages include the cost of equipment and sense of patient presence, in other words immersion [10]. The level of immersion is how much the patient feels to be part of the surrounding virtual environment. The correlation between the patient's presence and the effectiveness of the therapy depends largely on the belief that what is around the patient in virtual reality does indeed occur in reality. This correlation can reach up to 82% for patients who have met the clinical requirements for anxiety disorder [11].

### III. SYSTEM FEATURES

The main feature of the system can be simplicity and intuitive control for therapists and subjects (patient). The therapist should add a new user/patient without difficulty, start a session, stop a session and watch a session record. This is also true for controlling the patient's part of application, where the patient's primary interaction with virtual objects is done using the Tap gesture.

Another feature of the system is use the local database to reduce the overall complexity of the application. One of the advantages of a local database is the fact that it is not necessary to secure free or paid hosting. Thus, therapists have all the user data locally and the chances of stealing this information are decreasing.

### IV. APPLICATION ARCHITECTURE

The basic solution architecture is depicted in Figure 1. The solution uses a Photon server that provides a connection between application parts.

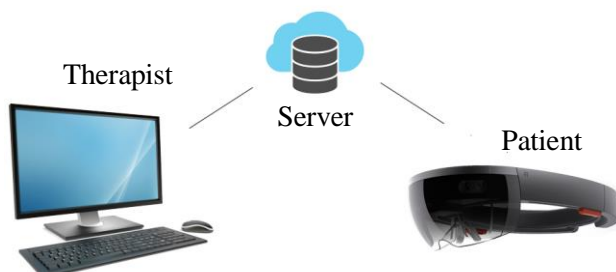

Figure 1. Basic solution architecture

Both parts, therapist and patient parts, are implemented as is shown in Figure 2. This solution model represents basic process sequence of the therapy. As can be seen, the communication between these two parts is at the control (management) level as well as at the data level. The Photon server usage enables fast and easy implementation of this communication.

In addition to this communication, the data flow is running between devices in local network. It is used for *models transfer* (ZeroMQ) and *real-time video stream* (UDP).

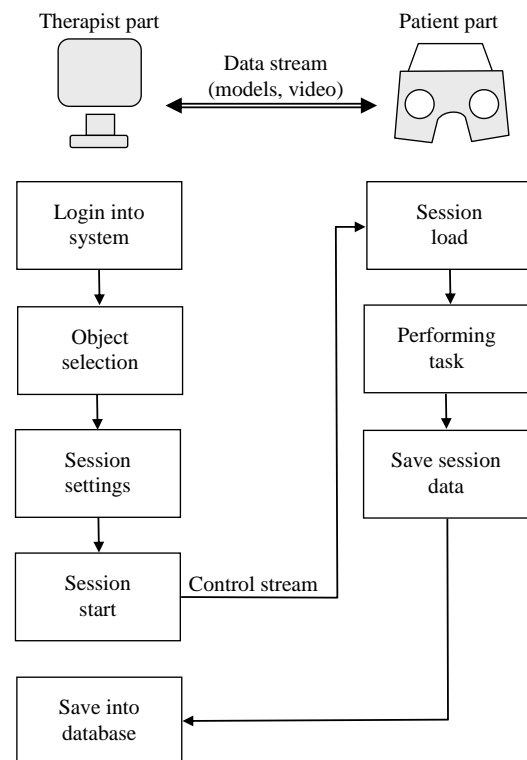

Figure 2. The solution model

#### A. Models transfer

The ZeroMQ [13] library and its implementation in C# NetMQ are used for sending models. ZeroMQ is based on ZeroMQ Message Transfer Protocol (ZMTP), and is a library for asynchronous message forwarding, without a specialized message broker. The system uses the Publish-Subscribe pattern where the PC application is publisher and HoloLens app is a subscriber. Publisher sends models and the subscriber downloads them to the messages queue, where they are processed by the BundleManager and stored for future use.

#### B. Real-time video stream

The UDP protocol is used to send a live stream from HoloLens. In this case, the PC application serve as UDP server and HoloLens application as UDP client (Figure 3. ). To start video stream, the user clicks the Start Video button to send the instruction to the HoloLens application to start sending a video. After camera initialization, the program registers listener to acquire each new video frame. Each of these frames is encoded from the format RAW to JPG format to reduce communication load and is subsequently sent as a byte array via the mentioned

UDP protocol. On the server side, these messages are converted to Texture format for display in the application.

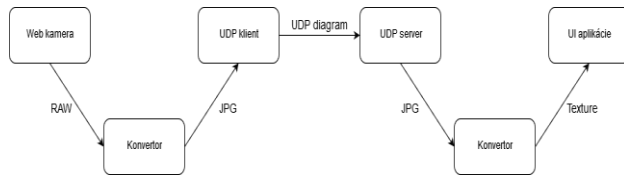

Figure 3. UDP video stream

### C. Object Serialization as database

The database is local and the SQL database is not used for storage, but the Object Serialization into a binary file. Using Object Serialization as a data storage is in the transformation of an object class in a series of bytes. This information is re-loaded into the object by deserialization.

Its advantage is that no installation to a computer is required compared to a SQL database, which could cause problems for therapists. Another advantage is that it is not possible to read it by the human eye because it is just a text representation of bytes compared to the format as JSON or XML. Of course, the data is not fully protected and just a small change in the file and the data become unreadable.

## V. APPLICATION INTERFACE

The application has two interfaces:

- Therapist interface and
- Patient/MS Hololens interface

### A. Therapist interface

The graphical interface of the therapist application is divided into two groups: *the system administrator interface* and *the therapist interface* (Figure 4). This distribution is primarily due to system requirements. The interface was created in Unity and was created with the intention of simplicity. The application is password protected. It is the user name that decides where the user will log in.

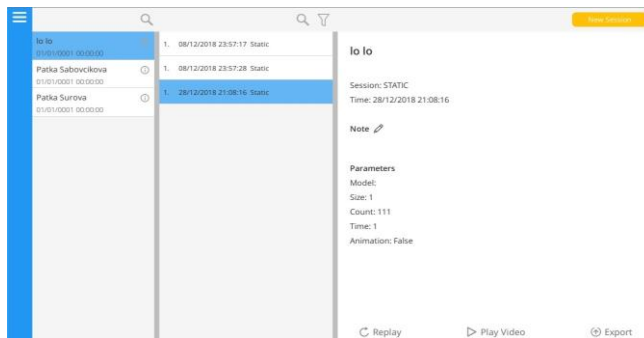

Figure 4. Main therapist interface

### B. Patient interface

The graphic interface in the HoloLens app is very simple and provides only important information for the user. As we can see in the Figure 5. the whole interface contains only 4 components. Green is the time from session start in mm:ss:sss format. This time can be turned off in session settings. Pink is the opening text that indicates waiting for a command from a PC application. When the session start signal arrives, the text is deactivated and reactivated only after the session has ended. The red frame indicates the start time, which counts off the start of the session by three seconds. It is also possible to turn off the time for session in the session setting. The last component is the application cursor itself in a yellow frame. It changes its size according to distance for a better feeling of control. The cursor is always in the center of the HoloLens view.

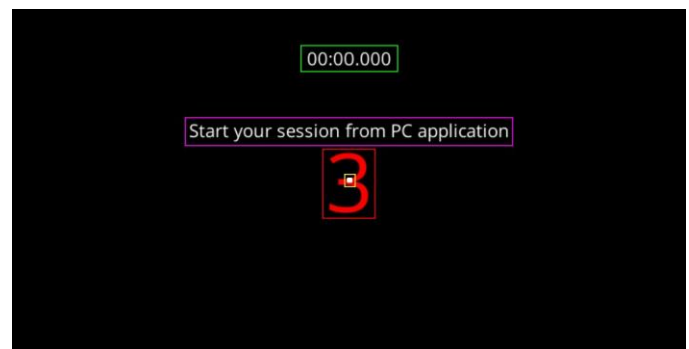

Figure 5. Graphics interface in HoloLens when therapy is starting

## VI. USER INPUT IN MR

A typical way to control the HoloLens app is usage of tap or drag gesture. These gestures are used with a point which is displayed to the user in the center of the view (Figure 6. Figure 7. : an example of arachnophobia). Usually it is a small circle or ball with a distinctive contrasting color. With this point, the user points to the desired object, which can be a model or a certain element of the graphical interface and a use tap gesture.

However, for the real hand controlling feeling was decided to implementation own user input. In practice, this means that the user's hand is being tracked and a transparent ball is drawn to the center of the palm. In this way, the user is able to interact with virtual objects with their own hands without the need to focus the cursor to object. This way of user input is very intuitive and the user feels as if he is actually holding the object (target). In the process of therapy, grasping (or just touching) a virtual phobic object can be a problem for the patient.

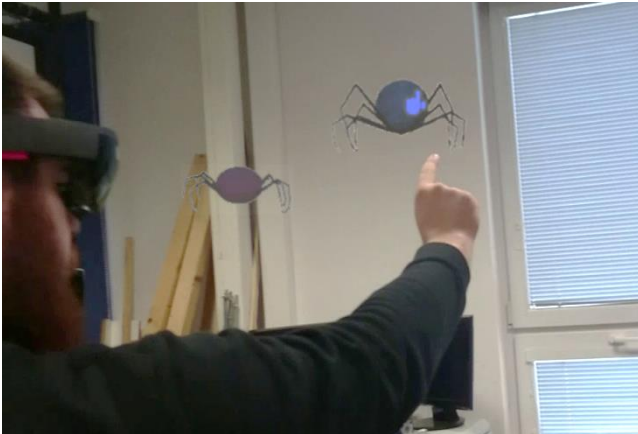

Figure 6. Patient control using hand gesture during session



Figure 7. Patient view in MS HoloLens

## VII. APPLICATION EVALUATION

Ten subjects were aged between 18 and 57 years of age. This group of people came from IT and economics. Testing time was not limited and varied depending on each subject. We can say, however, that the total time of testing was within 15 minutes. Subjects did not suffer from any known phobias and were shown a model of a green cube and spider for testing purposes. Subjects were tested in coordination, accuracy, and positioning modes. Subjects performed test with test parameter to get acquainted with the mode and control of the mode. Subsequently, these tests were performed:

- Coordination - One hand one target
- Coordination - Two hands one target
- Coordination - One hand many targets
- Accuracy - Push the object
- Accuracy – Grasping / Touch the object
- Location selection -  $N : 1$
- Location selection -  $N : N$

Upon completion, the subjects were asked a SUS questionnaire to determine their subjective feelings about using this system. The questionnaire contained these questions (answers statistic in brackets):

- Would you recommend this system for therapists? (100/0% y/n)
- Do you think that the therapist's application/interface is clear? (100/0% y/n)
- Do you think that this system can help in the therapy of phobias? (80/20% y/n)
- Do you think that controlling the application in MS HoloLens was easy? (0/0/4/3/3 level 1/2/3/4/5 best)
- Would you undergo this form of phobia therapy? (90/10% y/n)

From the achieved measured results in individual testing modes, we can see that the system provides various time values. The times of the subjects are usually decreasing to further repetitions of the same test. In our opinion, this is a consequence of getting used to both the displayed model and the displayed situation. The average times of the subjects also differed from each other. This difference is due to differences in subjects, as there were 8 men and 2 women aged 18 to 57 years.

Regarding the answers in the provided SUS questionnaire, we conclude that the users liked the system and would undergo this form of therapy. The subjects also did not have a problem with the proposed method of control. The whole system was perceived by the subjects as simple and clear to use and thus they perceive its use in therapy positively. One of the disadvantages of this system is, especially for some subjects, the weak immersion of the experience.

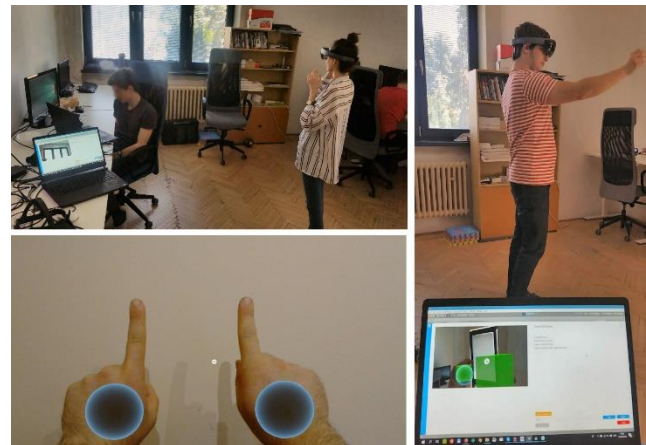

Figure 8. Examples from system evaluation

## VIII. CONCLUSION

This article describes the implementation of the use of virtual reality in the phobia therapy process. The designed system provides 3 different subjects testing modes. System also provides the management of subjects and the history of individual therapies.

Therapist has a option to see subject's test through real-time video stream.

Testing confirmed the functionality of the proposed system and the variety of measurement results. This difference is due to the difference of subjects. In addition to direct testing of the system, a questionnaire was submitted to subjects to obtain their subjective view of working in such a system. Questionnaires confirmed that operators would use this system and perceive it as easy to use.

Future development may be focused on porting the system to a collaborative virtual reality environment developed by the LIRKIS laboratory, the authors' home laboratory. This environment will allow the therapist to better participate in therapy process and it may increase the immersion of the patient experience. It could be possible to control a phobia object (e.g. a spider in the case of arachnophobia) as a therapist avatar. Such an approach can significantly change the usual processes of a therapy.

#### ACKNOWLEDGEMENT

This work has been supported by the APVV grant no. APVV-16-0202 "Enhancing cognition and motor rehabilitation using mixed reality".

#### REFERENCES

- [1] N. de Bruin, D. Bryant, J. MacLean and C. Gonzalez, "Assessing visuospatial abilities in healthy aging: A novel visuomotor task," *Frontiers in Aging Neuroscience*, vol.8, 7 pp., 2016.
- [2] D. Kravitz, K. Saleem, C. Baker and M. Mishkin, "A new neural framework for visuospatial processing," *Nature Reviews Neuroscience*, vol.12, no. 4, pp.217–230, 2011.
- [3] I. Farkaš, B. Cimrová, J. Rybár, M. Takáč and A. Lúčny, „Cognitive Science and Artificial Intelligence“, published for the University of Hradec Králové within the project "Information, Cognitive and Interdisciplinary Research Support", available: <http://cogsci.fmph.uniba.sk/hk/kapitoly.pdf> (in slovak)
- [4] R. L. Spitzer and J. B. Williams, *Diagnostic and statistical manual of mental disorders*, 2005.
- [5] Š. Korečko, M. Hudák, B. Sobota, M. Marko, B. Cimrová, I. Farkaš, and R. Rosipal, „Assessment and training of visuospatial cognitive functions in virtual reality: proposal and perspective," in *2018 9th IEEE International Conference on Cognitive Infocommunications (CogInfoCom)*, pp. 39-44, IEEE, 2018.
- [6] P. M. Yellowlees, K. M. Holloway, and M. B. Parish, "Therapy in virtual environments—clinical and ethical issues," *Telemedicine and e-Health*, vol. 18, no. 7, pp. 558–564, 2012.
- [7] S. Bruck, P. A. Watters et al., "Cybersickness and anxiety during simulated motion: Implications for vret." *Annual Review of Cybertherapy and Telemedicine*, vol. 144, pp. 169–173, 2009.
- [8] R. Segal, M. Bhatia, and M. Drapeau, "Therapists' perception of benefits and costs of using virtual reality treatments," *Cyberpsychology, Behavior, and Social Networking*, vol. 14, no. 1-2, pp. 29–34, 2011.
- [9] J. McGonigal, *Reality Is Broken: Why Games Make Us Better and How They Can Change the World*. Penguin Press, 2011. [Online]. Available: <http://books.google.co.uk/books?id=yiOtN kDJZgC>
- [11] W. Barfield and T. A. Furness, *Virtual environments and advanced interface design*. Oxford University Press on Demand, 1995.
- [12] "Mental illness." [Online]. Available: <https://www.nimh.nih.gov/health/statistics/mental-illness.shtml>
- [13] "Zeromq," 2019. [Online]. Available: <http://zeromq.org/>

# Wheelchair Simulator in Web Virtual Reality

B. Sobota<sup>\*</sup>, M. Mattová<sup>\*</sup>, J. Bogušciak<sup>\*</sup>, M. Hudák<sup>\*\*</sup>, Š. Korečko<sup>\*</sup>

<sup>\*</sup> Department of Computers and Informatics, Faculty of Electrical Engineering and Informatics, Technical University of Košice, Slovak Republic

<sup>\*\*</sup> Siemens Healthcare s.r.o., Košice, Slovak Republic

branislav.sobota@tuke.sk, miriama.mattová@tuke.sk, jakub.bogusciak@tuke.sk, marian.hudak@siemens-healthineers.sk, stefan.korecko@tuke.sk

**Abstract** – The aim of the paper is wheelchair simulation description using web virtual reality technologies. The first part of the paper is dedicated to description of existing solutions and their subsequent comparison. Secondly, problem of design efficiency is described as well as the frameworks that simulator serves. Next part is dedicated to designed scenes in which the user will be able to move. These scenes involve everyday problems of the person depended on the wheelchair. The last part of the paper contains the implementation description. This includes all the essential steps needed to create an effective simulator. It also includes experimental verification to determine the stability of the simulator. The conclusion of the paper contains an indication of the current state of the simulator and its possible development.

**Keywords:** wheelchair, virtual reality, simulation, collaborative virtual environment

## I. INTRODUCTION

Modern information technologies penetrate almost every aspect of our lives. Virtual reality and related technologies are also a part of this phenomenon. The recent COVID-19 pandemic situation noticeably increased the importance of online learning. There is a growing demand for more interactive and smart solutions and online learning is starting to be preferred even in the areas dominated by the classical approaches. The online education has relatively good results in its current form, where it offers digital content using standard multimedia (audio, still images and video). However, to explain more challenging concepts from areas such as physics, biology, chemistry or history, it would require significantly more interactive presentation of the content. One of the most developing technologies that could significantly increase the level of interactivity is virtual reality (VR) [1]. Commonly, deployment of web-based VR applications yields positive results in any field of usage [3]. In order to the standard VR applications, web-based VR can provide sharing of virtual content and user collaboration in the real-time [4]. The most effective way to practice remote therapy and training are collaborative virtual environments (CVEs) offering unlimited functionality and being multipurpose [5].

In 2019, the LIRKIS G-CVE (Global Collaborative Virtual Environments) [6] was designed in authors home laboratory LIRKIS as a web-based globally accessible VR/MR system over the internet. The system includes Entity-Component-System pattern that allows the rapid development of virtual environments with various extensions and features. Each of the components can perform different functionality: processing physical effects and object collisions, obtaining inputs from the VR/MR interfaces, monitoring user interactions and managing virtual entities. All CVEs in LIRKIS G-CVE [7] are accessible via web browsers. The rendering of the entire 3D content is performed on the client side (Client-Side Rendering). The communication between the system and users is employing the client-server model to share data over the network.

There are accidents every day that results in injuries after which people are temporarily or permanently immobilized. These people suddenly find themselves in a wheelchair and have no experience in operating it. Although they are provided with a number of courses to gain wheelchair skills, it is often financially unavailable. This paper is dedicated to description of wheelchair simulator using web virtual reality technologies.

## II. RELATED WORKS

There are many existing solutions for wheelchair simulator. Some of them are dedicated to electrical wheelchair. It was possible to obtain information about environment impact on user using these simulators, how they perceive them, how to approach movement, what is the goal of individual simulators and so on. The created simulator drew from the following existing simulators:

- *Electrical wheelchair simulator using a game controller* – When using this simulator [8], users will encounter two types of obstacles while navigating the environment. They need to verbally express whether it is possible to overcome the first one. In the second type of obstacles they go

through the environment without colliding. After completion, users will fill out a questionnaire for feedback.

- *Electrical wheelchair simulator using the built-in input controller* – Using this simulator [9], users go through both real and virtual environments. Virtual environment is designed same as the room in real environment as well as routes that users will go through. Firstly they take route displayed on the floor in real room and then they are asked to repeat the route in virtual room. During the attempts the time is measured and later on evaluated.
- *Electrical wheelchair simulator with possibility to select input and output options* – Simulator [10] has two possible uses. The first one includes use of virtual headset together with controllers, and the second one includes use of projector and eye motion sensor. Main goal is to create safe environment for wheelchair training. This simulator uses a virtual headset as the primary option of use. Users go through the virtual environment on predetermined route on which the cones are located.
- *Manual wheelchair simulator with own motion sensor* – This simulator [11] uses manual wheelchair for which virtual environment is created. In this environment user can move freely. User can also express his/hers sensation verbally. Researchers give them various tasks during testing such as going to a high border which is impossible to pass through in virtual environment as well as in real environment.
- *Manual wheelchair simulator with automatic scenario generation* – The goal of this simulator [12] is to create automatic scenario generation in which user can move. Users' wheelchair skills are tested before and after use of simulator. Aspects such as scenario completion speed or accuracy along the generated route are taken into account.
- *Electrical wheelchair simulator for children training* – The purpose of this simulator [13] is realization of an electric wheelchair for 13-16 years old children with multiple disabilities. This simulation should teach children to operate electrical wheelchair.

All simulators are using Unity 3D graphic core from the software point of view as it has great optimization for virtual reality application development. From the hardware point of view the majority used HTC Vive headset, because they were affordable and

of sufficient quality in that time. When Oculus Quest headset was presented, it was more convenient to build the application on this headset as it is even more affordable and development is easier, because it is android based platform.

### III. SYSTEM DESIGN

System functionality is shown in Figure 1., by which it is possible to observe individual realizations between objects and subjects, which occur in the given simulator. The main actor is considered to be the user who has headset on the head. This headset will launch web browser, which can run and render virtual reality environment. The user can interact with the environment using the controllers, which sends the data to the web browser. Browser will process the input from controller and update virtual environment with a minimal response.

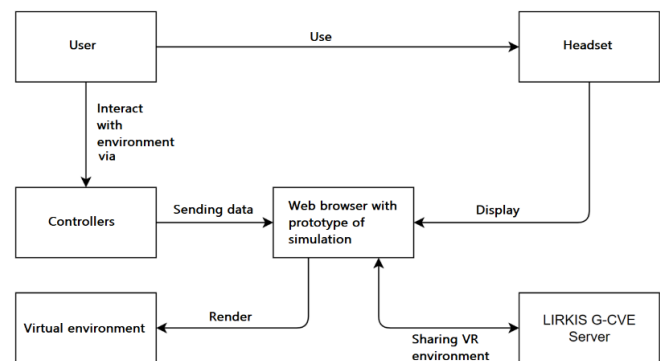

Figure 1. Conceptual model of the system

Virtual environment contains several scenes, in which user can move. However, only hallway with elevator is mentioned in this article for brevity and simplicity. In creation process of the scene, it was needed to take into account what will be happening in the scene, the way the user will move, what objects will scene contains and lastly how will scene look. Due to this facts, it was needed to create simple diagram, which contains the most important parts of the scene. Diagram is shown in Figure 2.

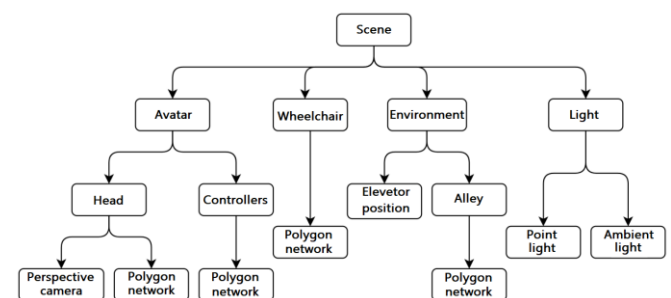

Figure 2. Scene design with an alley and an elevator

As was mentioned, the solution is based on LIRKIS G-CVE platform. The platform itself uses

the following technologies in this version of simulator:

- *A-frame version* – It was used 1.0.4 version of this framework for environment rendering and for entity and objects visualization.
- *Networked-aframe* – It was used version 0.7.1. This technology is used for object sharing between users, object rotation, object scaling, coloring and color changing, visibility and so on. This technology include implementation of collaborative environment. Only selected objects are shared.
- *Aframe-extras* – It was used 6.1.1 version of this technology. It has build-in frameworks which enable to work with 3D controllers and use the inputs of the user device to move in virtual environment. It contains functionality of model assignment into virtual reality environment.
- *Aframe-physics-system* – System uses physical subsystem called *physi.js*. It is possible to add physics into virtual environment thanks to this system. Component called *static-body* provides colliding logic into environment and is assign to all walls, floors and ceiling. Thanks to this component users avatar will not fall down through the floor or cannot pass through walls because it secures the collision between the avatar and other entity. If entity has assigned *static-body* its position in the world is static and unchangeable, which means that no other physics has influence on such entity.
- *WebRTC*– This system is communication standard, which is used for communication via web browsers in real time. This system was used because it is compatible with given *aframe-networked* version.

#### IV. SYSTEM IMPLEMENTATION

Implementation is divided into specific steps needed for creation of functional simulator of wheelchair in web virtual reality. The most important parts of simulator were to create controller, which belongs to the headset, how to capture its values from analog lever correctly, so the values can be transformed into movement and rotation of wheelchair.

After values were captured, movement component was created and implemented into wheelchair. This component processed the values and according to the direction of the analog lever, the movement or rotation was performed. Movement of wheelchair was difficult to resolve as in real life, if lever is pushed forward wheelchair will move in its direc-

tion. But in virtual environment, if lever is pushed, wheelchair moved on the z axis. This problem was solved by obtaining actual wheelchair rotation in world. From this rotation sine and cosine was calculated. Then the two vectors were created where first one was reset. Second vector contains amount of movement. This value is saved in a vector on z axis so the movement forward or backward can be performed. Lastly the final directional vector is calculated and saved into reset vector. Vector is then added into value of actual position of wheelchair.

Every scene was divided into two subscenes, which shared the same environment. In first subscene, user will spawn seated in a wheelchair. After VR mode transition, scene is adjusted for the correct functionality in headset. After second subscene connection, user is spawn into environment as guest and can watch the user in the wheelchair. This user can verbally help other user as it can help with any difficulties associated with the virtual environment. These subscene is more likely adjusted to desktop computers as it is more reasonable to help the user on wheelchair using this platform. The user appearance in scenes is shown on Figure 3. together with possible obstacles.

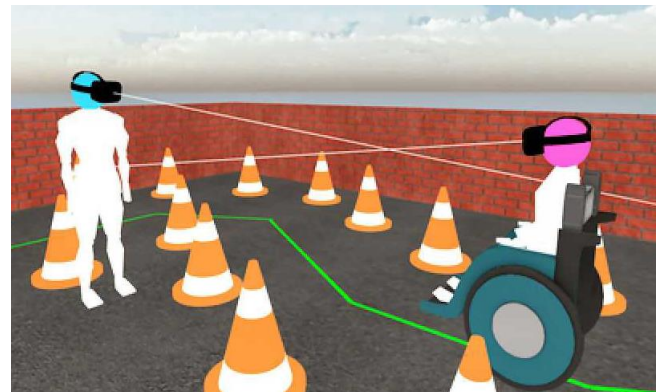

Figure 3. Visual representation of wheelchair user avatar and visitor avatar

After correct division of scenes, it was needed to handle the entity and models sharing in real time. This is achieved thanks to so-called templates, thanks to which are information shared. After template definition in HTML section, it is needed to use it on entity. This is achieved thanks to giving the attribute *networked* into entity, in which is template put. After this process, it is needed to share this information programmatically for other users in the scene. Thanks to scheme it is possible to determine which information will be shared about particular entity. For example, if the rotation is unchangeable, there is no need to share this information. These scheme is written in *JSON* object, which is shared between all users.

After scene creation, it was needed to consider how floor plan will be designed. Unwanted effect is for example large scene. It can result into too much freedom of movement. Oppositely, if the alleys were too small to pass through. After this reconsideration, component for movement was created, so the widths, the heights, the sizes of areas can be tested. Thanks to this it was possible to create most authentic environment corresponding to reality. Figure 4. shows such environment.

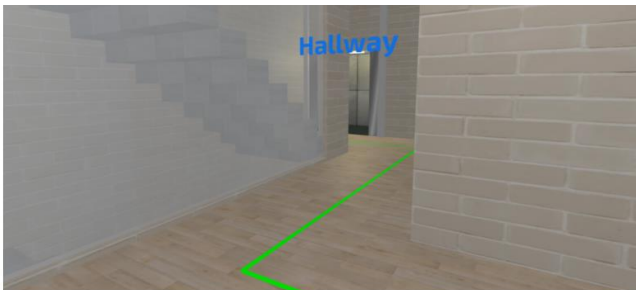

Figure 4. Visual representation of scene with elevator and hallway

After correct dimension design, it was needed to implement floors, walls and ceiling into scene. These entity does not need to be shared between users as it is static object. Textures were added onto objects so the scene will appear more authentic. For authenticity, lights were added as well. Two of them are so-called point lights in main room where user is spawn initially and second one is located where the elevator is. This lights works as the light bulb in real life so it is possible to observe shadows. Another light called ambient light is also in the scene to create the feeling of the bright day. Texts and arrows on the floor are added into scene as well for user to know, which direction he/she should go.

Lastly, web page was created so the user can switch between scenes. Every scene contains two buttons. First button is *Patient*, which redirect user into scene as a user on a wheelchair. Second button is *Visitor*, which redirect user into scene as a standing visitor.

## V. SYSTEM VERIFICATION

After implementation of wheelchair simulator in web virtual reality, it was needed to test system stability. This was achieved by capturing frames per second every second during whole minute. Every scene contains different number of triangles, models and entity. Testing took place on desktop computer as well as Oculus Quest headset. Result values were compared and the conclusion of testing was drawn from them.

This method is used on every other scenes as well, but for the simplicity only one sample graph is shown on Figure 5.

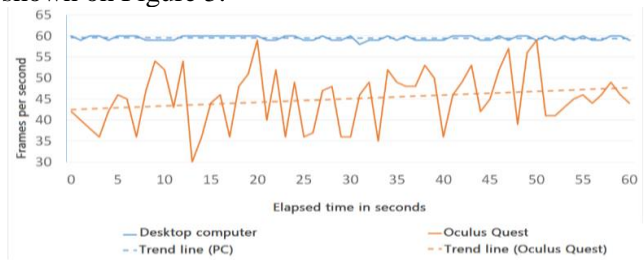

Figure 5. Evaluation graph from testing in elevator and hallway scene

From the graph it is possible to observe that number of frames were similar and fixed whole time while using the desktop computer. This is due to the fact, that desktop computers have more powerful processor and graphic card. On Oculus Quest device frames per second were significantly lower, but trend line shows that number of frames per second were gradually increasing.

After evaluation of previous testing another test was run. Goal was to improve stability and number of frames per second on Oculus Quest device. Modification of textures were implemented for lower rendering difficulty. Some of the light were deleted from the scene as well. Only ambient light was kept and intensity of lightness increased. Figure 6. shows the results of testing after this changes.

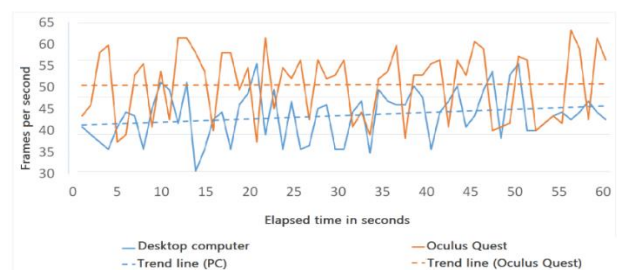

Figure 6. Evaluation graph for adjusted elevator and hallway scene

Adjustment of scene helped to increase frames per second in Oculus Quest headset. As it is possible to observe from the graph, in many places frames per second were under the value 60. It was not possible to gain more than 60 frames per second on desktop device as its refresh rate of output device was 60 hertz. Thanks to higher frames per second it was possible to create better authenticity of simulator as well as reduce risk of motion sickness and another side effects of using VR headsets. After frame calculation before and after adjustment it was found that 8 frames per seconds in average was in addition of changes. It is about 18% improvement.



## VI. CONCLUSION

As it has been shown, LIRKIS G-CVE is a suitable solution for online collaboration in web-based virtual reality, with a variety of application areas in mind.

Final version of simulator contains several scenes, which wheelchair user can try. Every scene contains different kind of movement and rotation for successful scene crossing. Scenes enable to test this skills without the risk of injury. For the correct practicing it is needed to use headset Oculus quest as the desktop computers do not share the authenticity. The example of the scene usage is shown in Figure 7.

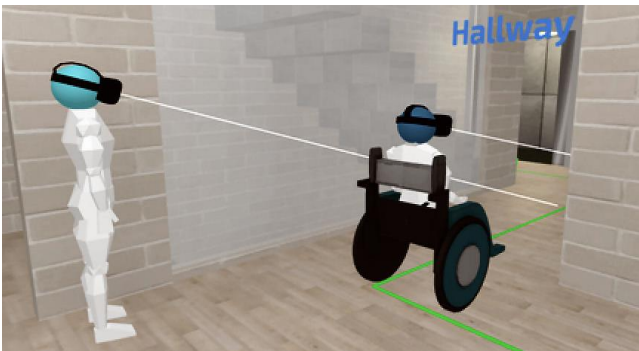

Figure 7. Example of scene usage based on Figure 4.

This system is possible to improve in many ways in future. One of the improvements can be the adjustment of the scenes, so the frames per second will not go below value 60. It is also possible to change the assets in the scenes such as models, textures and details, so the scene will look more realistic. Another possible extension is to add more scenes (e.g. a movement into/from lift), where user can train himself/herself. Adding more sophisticated physics is also one of the possible improvements, like collision between users (more wheelchair users in shared virtual environment). Last but not least the idea of user which push the wheelchair can be implemented, as such user can help the user in wheelchair if needed.

## ACKNOWLEDGEMENT

This work has been supported by the KEGA grant No. 035TUKE-4/2019: „Virtual-reality technologies and handicapped people education“

## REFERENCES

- [1] Sobota, B.; Korečko, Š.; Hrozek, F.: On building an object-oriented parallel virtual reality system; In: Central European Journal of Computer Science. Vol. 2, no. 3 (2012), p. 261-271. - ISSN 2081-9935
- [2] Hudák, M.;Korečko, Š.; Sobota, B. : Enhancing Team Interaction and Cross-platform Access in Web-based Collaborative Virtual Environments, In: Proceedings of 2019 IEEE 15th International Scientific Conference on Informatics, IEEE, 2019, pp. 160-16.
- [3] L. Jiang, M. Masullo, L. Maffei, F. Meng, and M. Vorländer, “A demonstrator tool of web-based virtual reality for participatory evaluation of urban sound environment,” *Landscape and Urban Planning*, vol. 170, pp. 276–282, 2018.
- [4] D. Seo, B. Yoo, and H. Ko, “Webizing collaborative interaction space for cross reality with various human interface devices,” pp. 1–8, 2018.
- [5] S. Huh, S. Muralidharan, H. Ko, and B. Yoo, “Xr collaboration architecture based on decentralized web,” pp. 1–9, 2019.
- [6] M., Hudák, M., Sivý. Web-based collaborative virtual environments to support cross-platform access, In: Poster 2019 International student scientific conference, Prague, 2019, pp. 178-182.
- [7] Sivý, M., Sobota, B., Korečko, Š., Hudák, M.: Virtualized Collaborative Learning Environment In The Process of Teaching People with Disabilities In: ICETA 2019 : 17th IEEE International conference on emerging elearning technologies and applications: Information and communication technologies in learning. Starý Smokovec, Slovakia. November 21-22, 2019, pp. 727-732.
- [8] A. Alshaer, H. Regenbrecht, and D. O’Hare, “Immersion factors affecting perception and behaviour in a virtual reality power wheelchair simulator,” *Applied ergonomics*, vol. 58, pp. 1–12, 2017.
- [9] J. K. Hernandez-Ossa, “Development and evaluation of a simulation system of electric-powered wheelchairs for training purposes,” Federal University of Espirito Santo, Brasil, 2018.
- [10] A. Yu and J. M. H. Elvesjo, “Eye tracker based contextual action,” 2016, uS Patent 9,507,418.
- [11] L. Y. Sørensen and J. P. Hansen, “A low-cost virtual reality wheelchair simulator,” in Proceedings of the 10th International Conference on Pervasive Technologies Related to Assistive Environments, 2017, pp. 242–243.
- [12] J. W. Li, J. Talavera, A. G. Samayoa, J.-M. Lien, and L.-F. Yu, “Automatic synthesis of virtual wheelchair training scenarios,” in 2020 IEEE Conference on Virtual Reality and 3D User Interfaces (VR). IEEE, 2020, pp. 539–547.
- [13] N. Rodriguez, “Development of a wheelchair simulator for children with multiple disabilities,” in 2015 3rd IEEE VR International Workshop on Virtual and Augmented Assistive Technology (VAAT). IEEE, 2015, pp. 19–21.

# Importance of Employee Training for Industry 4.0

S. Stanisavljev\*, D. Radosav\*, Z. Košut\*, S. Jokić\*, J. Vukajlović\*, S. Zec\*\*

\* University of Novi Sad , Technical faculty Mihajlo Pupi in Zrenjanin, , Republic of Serbia

\*\* Hotel Georgia, Vancouver, British Columbia, Canada

sanja.stanisavljev@tfzr.rs , dragica.radosav@tfzr.rs , zlatko.kosut@tfzr.rs , snezana.jokic@tfzr.rs ,  
jelena.vukajlovic@tfzr.rs , sashazec@hotmail.com

**Abstract** - The authors analyze the importance and necessity of training, education and development of employees for the successful implementation of modern concepts, especially for Industry 4.0. Modern employment requires permanent education and training of managers and all employees. Dynamic development of information technologies, automation and digitalization of business processes conditions the application of modern methods, concepts and tools. Training, education and development of employees bring numerous benefits and more successful implementation of modern concepts and monitoring of trends and changes in the market.

**Keywords:** Training, Training and development of employees, Industry 4.0

## I. INTRODUCTION

The modern market and organizations are facing numerous changes that are frequent and turbulent. It is essential that organizations monitor and manage change, apply new tools, strategies and concepts in order to maintain and achieve competitiveness. Without knowledge, knowledge management, training and employee development will not succeed in this endeavor.

Changes are inevitable and companies must follow them, to go one step ahead of them for survival and competitiveness. Only in this way and with a quick response to customer requests and wishes will the market.

It is crucial to understand the role of Industry 4.0 in today's rapidly changing and competitive business environment; where companies face challenges in working with big data and making quick decisions to improve productivity [1].

## II. INDUSTRY 4.0

The goal of modern industry is a timely response and response to customer demand in the form of a higher quality product than competitors. Speed, precision and quality can be achieved with the latest technology, software, digitalization of business

processes, good connectivity of all activities of the organization.

Industry 4.0 is focused on individual production according to customer preferences. This creates huge changes and different opportunities for products and support processes. These changes can be achieved by digitizing production and business processes. The central pillar of Industry 4.0 is a smart factory that networks machines, robots, facilities, rolling stock and people into one system. This networking is possible through standardized communication interfaces, advanced sensors, control elements and software with models for managing processes, processes, machines, products and services.

Industry 4.0 encompasses the development and integration of innovative information and communication technologies in industry, with the aim of encouraging intelligent networking of processes (production and business) and products along the entire value chain [2].

Schumacher et al. [3] provide a more detailed definition of Industry 4.0 by referring to recent technological developments where the internet and support technologies provide a backbone for incorporating physical objects, human beings, smart machines, product lines and processes across organizational boundaries in order to form a new sort of smart, networked, agile value chain. Industry 4.0 therefore implies constant communication with all of the parts of the value chain that are outside the company, especially suppliers and customers. Real-time sharing of information among all the different stakeholders makes the supply chain more responsive [1].

Regarding the fourth industrial revolution, i.e. "Industry 4.0", China cooperates with all industrialized countries. Thus, they are working with Germany on standardization, a German-Chinese alliance for vocational training and education has been created, as well as a common

framework for the action plan named “Design innovation together!”[4] China also cooperates with other countries, such as Switzerland, France, etc. The Chinese government is taking all steps to make Chinese industry and its development play an important role in the development of the world market, in other words, to make China one of the most technologically advanced countries in the world by 2025.

### III. EDUCATION 4.0

The implementation and efficiency of Industry 4.0 requires knowledge workers, who will be able to easily master and apply new skills, tools and concepts, who will undergo training, education 4.0.

Education 4.0 is a response to the needs of IR4.0 where human and technology are aligned to enable new possibilities. Fisk [5] explains that the new vision of learning promotes learners to learn not only skills and knowledge that are needed but also to identify the source to learn these skills and knowledge. Learning is built around them as to where and how to learn and tracking of their performance is done through data-based customization. Peers become very significant in their learning. They learn together and from each other, while the teachers assume the role of facilitators in their learning.

Dunwill says that the advancement of technologies keeps on changing and transforming the teaching method and the setting of the learning process. In fact, there will be more changes in the future. Some of the common changes that have been embraced by institutions includes lecturers post students’ grades and assignment online, students use collaborative software/application to complete group tasks, students complete their assignments online and upload them in an online class portal or the institution learning management system, students’ high dependency on cloud storage to store their work and communication among students, parents, lecturers and administration is done via social media platforms [6].

The changes that take place in Education 4.0 really describe the learning preference of the Gen Z students. Based on the sharing session above, it is not impossible for a language course to adapt to the changes. It is about time for class instructors to consider integrating more current technologies in their teaching methodology. The students that they have now have different preference than students that they had 10 years ago. Integrating more current technologies will make the instructors more creative in designing their lessons, thus making the learning more interesting [7].

It is very important that teachers, professors, mentors, managers are leaders, to be teachers 4.0 and thus facilitate and guide students, employees to adopt, apply modern technology, available software, programs, everything that is offered to them to faster, better reached the goal more efficiently.

The 21st century is a century of globalization. Therefore, learning content is expected to be able to reach 21st-century skills. First, learning and innovation skills include mastering diverse knowledge and skills, learning and innovation, critical thinking and problem-solving, communication and collaboration, and creativity and innovation. Second, skills digital literacy includes information literacy, media literacy, and ICT literacy. Third, career and life skills include flexibility and adaptability, initiative, social and cultural interaction, productivity and accountability, and leadership and responsibility [8].

One of the emerging technologies in the field of education today is augmented technology and virtual reality (AR/VR), has begun to be adopted as a medium of learning in the classroom and also research aids in the laboratory [9]. AR/VR technology can be used to support education and improve student learning effectiveness. For example in the process of learning mathematics related to the topic of discussion of geometry, learning biology material with the topic of human digestive systems, the process of cell division, it is learning activities and experiments imitating various objects that are around, and for other learning complex and challenging to do real. Learning media that use this technology can quickly improve students' understanding because of 3D objects, text, images, videos; audio can be displayed to real students [10].

### IV. EMPLOYEE TRAINING FOR 4.0 INDUSTRY

In order to progress and easily manage changes that are becoming more dynamic, employees must adapt, they must improve their knowledge and acquire new knowledge, techniques and skills that are not through their education. That is why it is very important that they attend seminars, trainings for education and development of employees.

Training in general sense means to equip employees with the essential skill sets to perform a job or to advance new skill. In this era of Industrial Revolution 4.0, employees should not only focus on acquiring the required skill set to perform the job rather they should prepare themselves to sustain this competition with the robots [11]. With the augmented implementation of digitalization and automation, the employees will have to equip themselves with the right skills to survive.

While the transformation processes towards Industry 4.0 are long term, companies have to take into consideration a strategic approach [12] to human resources and human development. From this point of view, intellectual capital and intellectual capital management has been a subject of interest of many researchers in the field of business management [13, 14]. Intellectual capital management is also presented as a concept that ensures sustainable competitiveness [15–17] and avoids ad-hoc solutions with higher levels of risks and costs. Intellectual capital is defined as knowledge and knowledge initiatives convertible into value [18, 19] and brings a schema for presenting qualities and potentials for sustainable development. There are several views at the breakdown structure of the intellectual capital model presented in literature [13, 19], usually consisting of three main components: human capital, structural (internal, process, or organizational) capital, and relationship (external or partners) capital. As human and organizational capital both contain knowledge and knowledge initiatives oriented towards inside the organization, the relational capital contains knowledge and knowledge initiatives oriented outside the company or towards partners and customers. Sustainable development according to this concept needs to incorporate all of these three components [20, 21]. Sustainable learning and sustainable human resource development therefore also need to contain not only human and structural (process) but also relationship knowledge initiatives [22].

Organizations should provide training and development programs to its workforce as it will enhance their level of productivity. The three major elements which determine an employee's performance are his abilities, skills and knowledge. Organizations should focus on providing training and development for these three major elements which will help them increase their employee's productivity.

## V. CONCLUSIONS

A new era of business, Industry 4.0 requires a new approach, a new way of learning, education, training of employees who will be able to overcome all obstacles.

Employee Training for Industry 4.0 requires a balance between respecting the skill sets that employees already have, while increasing their abilities. This can be done if we improve the knowledge, skills, especially digital skills of employees, digital performance. It is important to use modern methods in order to raise the use of new technologies among employees, to create a climate

that will motivate employees to progress, improve, be creative, innovative and eager for knowledge.

The benefits of Industry 4.0 are numerous only if we have employees, human resources who possess the power of knowledge and possess the skills necessary for the 4.0 industry. We achieve this by developing staff, training and educating employees for the modern market and competition.

Training employees for industry 4.0 requires a balance between honoring the skill sets employees already have while adding to their abilities.

## REFERENCES

- [1] Thoben, K.-D., Wiesner, S., and Wuest, T., "Industrie 4.0" and Smart Manufacturing – A Review of Research Issues and Application Examples", *Int. J. of Automation Technology*, Vol.11 No.1, 2017, pp.4-16.
- [2] Barreto, L., Amaral, A., Pereira, T. *Industry 4.0 implications in Logistics, Manufacturing Engineering*. Society International Conference 2017, Science Direct.
- [3] Schumacher A., Erol S., and Sihm W. (2016), A Maturity Model for Assessing Industry 4.0.
- [4] Karabegović, I. i dr. 2018. *Implementacija „Industrije 4.0“ primjenom robotai digitalne tehnologije u proizvodnim procesima u Kini*, Tehnika – Mašinstvo 67, 2018, Univerzitet u Bihaću, Tehničkifakultet, Bihać.
- [5] P. Fisk, Education 4.0 ... the future of learning will be dramatically different, in school and throughout life. Retrieved from <http://www.thegeniusworks.com/2017/01/future-education-young-everyone-taught-together/>. Clerk Maxwell, A Treatise on Electricity and Magnetism, 3rd ed., vol. 2. Oxford: Clarendon, 1892, 2017, pp.68–73.
- [6] Dunwill, E. (2016). 4 changes that will shape the classroom of the future: Making education fully technological. Accessed from <https://elearningindustry.com/4-changes-will-shape-classroom-of-the-future-making-education-fully-technological>.
- [7] Anealka Aziz Hussin, Education 4.0 Made Simple: Ideas For Teaching 93 *International Journal of Education & Literacy Studies* IJELS 6(3), 2018, pp.92-98
- [8] Trilling, B., & Fadel, C., 21 Century Skills. 21st Century Skill, 2009.
- [9] Zhu, K., Virtual reality and augmented reality for education (pp. 1–2). Association for Computing Machinery (ACM), 2016, <https://doi.org/10.1145/2993363.3006041>
- [10] Delipiter L., Education and Industrial Revolution 4.0, *Jurnal Handayani (JH)*. Vol 10 (1) Juni 2019, hlm 48-62
- [11] Navya Ninan, Joel C.R, Mary R.T., Training the workforce for Industry 4.0, *International Journal of Research in Social Sciences*, Vol. 9, Issue 4, 2019, pp.783
- [12] Papulová, Z.; Papula, J. Conscious thinking as an approach to strategic analysis. *J. Organ. Stud. Innov.* 2015, 2, pp 39–48.
- [13] Dumay, J.; Cuganesan, S. Making sense of intellectual capital complexity: Measuring through narrative. *J. Hum. Resour. Cost. Account.* 2011, 15, pp 24–49.
- [14] Papula, J.; Volná, J. The Level of Intellectual Capital Management in Slovak Companies. In *Proceedings of the 6th European Conference on Intellectual Capital*, Trnava, Slovak Republic, 10–11 April 2014; Academic Conferences and Publishing International Limited: Reading, UK, 2014; pp. 135–144
- [15] Matos, F.; Vairinhos, V.M. Intellectual Capital Management as a Driver of Competitiveness and Sustainability. *J. Intellect. Cap.* 2017, 18, 466–469.
- [16] Galabova, L.; Ahonen, G. Is intellectual capital-based strategy market-based or resource-based? On sustainable strategy in a knowledge-based economy. *J. Hum. Resour. Cost. Account.* 2011, 15, 313–327.

- [17] Todericiu, R.; Stăniț, A. Intellectual Capital—The Key for Sustainable Competitive Advantage for the SME's Sector. *Procedia Econ. Financ.* 2015, *27*, 676–681.
- [18] Edvinsson, L. Developing intellectual capital at Skandia. *Long Range Plan.* 1997, *30*, 366–373
- [19] Papula, J.; Volná, J. Intellectual Capital as Value Adding Element in Knowledge Management. In *Proceedings of the International Conference Knowledge as Business Opportunity*, Celje, Slovenia, 22–24, 2011; pp 497–504.
- [20] Jordão, R.V.D.; de Almeida, V.R. Performance measurement, intellectual capital and financial sustainability. *J. Intellect. Cap.* 2017, *18*, pp 643–666.
- [21] Pilková, A.; Papula, J.; Volná, J.; Holienka, M. The influence of intellectual capital on firm performance among Slovak SMEs. In *Proceedings of the 10th International Conference on Intellectual Capital, Knowledge Management and Organisational Learning*, Washington, DC, USA, 24–25 October 2013; Academic Conferences and Publishing International Limited: Reading, UK, 2013; pp. 329–338
- [22] Stachová K, Papula J, Stacho Z, Kohnová L. External Partnerships in Employee Education and Development as the Key to Facing Industry 4.0 Challenges. *Sustainability*. 2019; *11*(2):345. <https://doi.org/10.3390/su11020345>

# The Impact of Augmented Reality in Architectural Design Using Combined Method of Data Aggregation and Segregation

A. Krstev\*, A. Velkova Krstev\*\*

\*Faculty of Computer Science, University of Stip, Republic of N. Macedonia,

\*\*MONOLIT GROUP – Stip, Republic of N. Macedonia,  
aleksandar.krstev@ugd.edu.mk, angela.velkova@outlook.com,

**Abstract:** Augmented Reality (AR) enables digital information to be superimposed and integrated into our physical environment. With many of us now at home during a global pandemic, AR is a tool that can help us transform our immediate surroundings into learning, work, and entertainment spaces. AR can help to bring the outside world in a form of a virtual view with 3D objects in your living room or residential area using headsets that are capable of giving such experience. There are three things AR does very well: visualization, annotation, and storytelling. There are examples in each of these areas that are both timely in the current reality and which can be built upon once cultural institutions, schools and workplaces reopen their doors and bring them into one new mixed world of opportunities. Research documents of the evolutionary processes of buildings can illustrate the changes needed for the spatial environment, advances in civil engineering technology, the transformation of social norms, and adaptive standards for the new civil building policies. Augmented reality has built a platform that allows brands to offer unique and more accessible digital experiences, providing memorable moments for consumers. One of the main reasons that retail brands invest in the development of this technology lies in the idea of enabling consumers to make better and more informative product decisions. The merging of these interoperability structures between technology on the one hand and architecture on the other hand provides a systematic pre-solution for making the right decision when designing and investing in capital and socially useful buildings.

## I. INTRODUCTION

Civil engineering is a professional engineering discipline that deals with the design, construction, and maintenance of the physical and naturally built environment, including public works such as roads, bridges, canals, dams, airports, sewage systems, pipelines, structural components of buildings, and railways. Civil engineering is traditionally broken into a number of sub-disciplines. It is considered the second-oldest engineering discipline after military engineering, and it is defined to distinguish non-military engineering from military engineering. Civil engineering can take place in the public sector from municipal public works departments through

to federal government agencies, and in the private sector from locally based firms to global companies.

The long cycle of design and construction is often overtaken by the rapid cycle of innovation in civil engineering and the new IT technology. As a result, some buildings are partially obsolete when they open, and almost every facility will be obsolete in some way before it reaches the end of its life. Flexibility design is a way to reduce the inconvenience and cost of these inevitable disruptions. Every design should have planned zones for future growth. When building and planning buildings and houses, the architectural environment that includes investors, clients, families, and staff should support treatment and views of the building concept in a friendly setting. However, the majority of our current buildings are built on a different foundation and are often seen as a direct cause of inadequate facilities in the eye of a modern architect and investors in today's civil engineering. The building and house design and design strategy, following the open theory of building separation, needs to be analyzed and evaluated to see if the design methods and principles are sufficient to support the customer needs to make the necessary changes. The research represents the importance of the separation of the system used in the design for house and building flexibility, as it allows for a significant change in all phases of the project (design, construction, and utilization) and points to the lack of a system that occurs when adopting design decisions based on which the right changes are made to the design for future development. For a better insight and presentation of what an architect has conceived as a conceptual solution, it is best to present it with the help of computer vision, i.e., through computer visualization before it is built. [1,2]

Augmented reality is a combination of digital interactive visual elements and sensory projections

translated into the real world. In this way, through the use of images, graphics, sounds and text, the digital world is combined with reality and creates a unique user experience. This technology allows us to create content that incorporates new patterns of context, meaning, and emotion. Such experiences create a bridge to present the authenticity, innovation, and creative vision of companies. As consumers, we share different parts of life with others every day. What we choose to express can take many forms, but the basic desire to share and show how we perceive ourselves and the world around us is strong, and the augmentative reality further elevates and enriches this sharing experience. From the prism of marketing, augmented reality has built a platform that allows brands to offer unique and more accessible digital experiences, providing memorable moments for consumers. One of the main reasons that retail brands invest in the development of this technology lies in the idea of enabling consumers to make better and more informative product decisions. The merging of these interoperability structures between technology on the one hand and architecture on the other hand provides a systematic pre-solution for making the right decision when designing and investing in capital and socially useful buildings. [3,4]

## II. RESEARCH METHODOLOGY

This paper describes concept of system that can systematically "extract" key data from 2D and 3D models from CAD / CAM software such as - AutoCAD, ArchiCAD, Google Sketchup, and similar ready-made software used in design bureaus, primarily for architects and construction engineers who process a variety of calculations such as statics, dynamics, design, and measurements for different types of objects. The idea is not only to extract the data but also to insert it with software that should make calculations defined according to norms and regulations that use them. The goal is to simplify and speed up the work in terms of quick calculations - bills, offers that are a crucial part of the daily work of an engineer in this field. According to the initial talks, the goal is to calculate the basic elements such as area and volume from which according to the established formulation will be given appropriate offers or suggestions to the engineer on what type of raw material to use in construction and what it would mean for the quality of construction from functional and economic character for the investor. Based on the work done so far and in a short time, the completion of the primary software for 3D visualization (augmented reality) is seen as a

perspective to upgrade that view with the possibility as a functional calculation of all elements that will be defined by both sides of the system performance team. software, but also to be able to connect to the software developed part if there is potential in that direction to improve the overall system for an architect / civil engineer who would work both in the office and in the field with his client.

The two system structures can interact from both engineering sides in the development of a software product that together with the existing hardware technology can help in presenting a conceptual solution and how it will be justified, but also how it will have as an environmental impact. This shows all the effects from an architectural point of view in the part of structural elements, and they are placed with appropriate descriptions from a technological and economic point of view in a given database. The same base provides an opportunity in such a projection - augmented reality review to see what the advantages of the given architectural solution are and how it will affect the investor.



Figure 1. AR Concept in Reality

In essence, the architect prepares the entire project in terms of design and converts it into an appropriate 3D model that is placed on a specific location that is provided for the construction of that building in this case it is a house for better showroom experience). In this model not only, the 3D model that is showed in mixed reality but also the data that comes with the 3D model such as length, width, material (price-based information) can be stored in a system data base to be used for further calculations when we change the material or the length of the building for example. This can provide us insight for the final pre-signed submission paper for the client or investor for a economical point of view.

## III. TECHNOLOGY USED TO DEVELOP THIS CONCEPT MODEL OF LEARNING AND COGNITION

This paper uses CAD / CAM technology to develop the conceptual design in this case AutoCAD and Google SketchUp which later with all its development stages is easily converted into a suitable 3D model (.fbx, .obj).

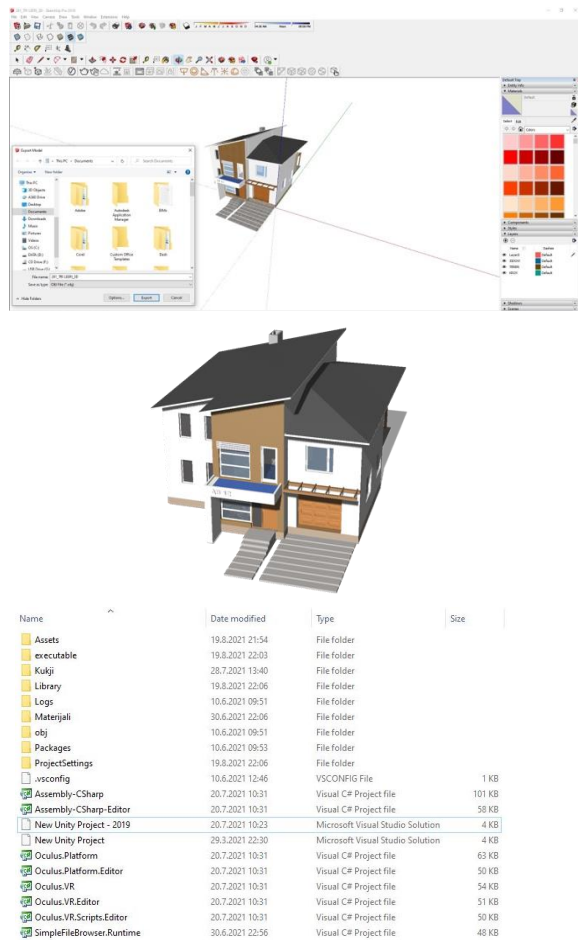

Figure 2. Architectural Concept and Design

From the software part, the combined development technology of C # and Unity3D was used to make a software segment-software that shows the 3D models or in this case there is a projected 3D object in a real position with appropriate coordinates (this is enabled by build in GPS developed module mounted on the laptop) in a scale of 1: 1.

C # - a programming language created by Microsoft at the initiative of Microsoft. NET and then approved as standard by Ecma (ECMA-344) and ISO (ISO / IEC 23270). C # is one of the programming languages designed for Common Language Infrastructure. C # is a simple, modern, multi-purpose programming language.

C # is a simple, modern, multi-purpose and object-oriented programming language.

- The language is intended for use in the development of software components suitable for use in distributed environments.
- Source code for portability is very important, as is program portability, especially for developers who know the C and C ++ programming languages.

- Support for internationalization is very important.
- C # is designed to be suitable for writing applications for both home and embedded systems
- C # applications are memory and energy efficient in their processing, the language is not designed to compete in performance and size with the C programming language or assembly language.

Unity is a cross-platform game engine developed by Unity Technologies, first announced and released in June 2005 at Apple Inc.'s The engine has since been gradually extended to support a variety of desktop, mobile, console and virtual reality platforms. It is particularly popular for iOS and Android mobile game development and used for games. It is cited to be easy to use for beginner developers and is popular for indie game development. The engine can be used to create three-dimensional (3D) and two-dimensional (2D) games, as well as interactive simulations and other experiences. The engine has been adopted by industries outside video gaming, such as film, automotive, architecture, engineering, construction, and the etc.

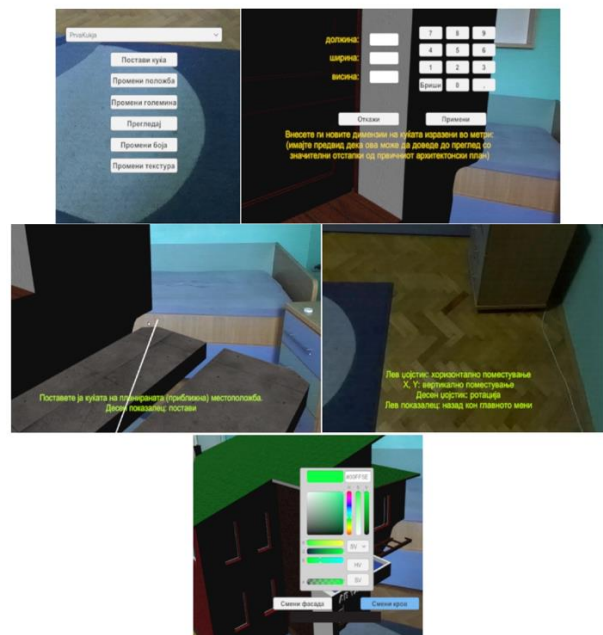

Figure 3. Developed AR Application

From the hardware part to fully experience this tool for real-time design and display of an already designed 3D object, a combination of virtual reality glasses and cameras from a suitable manufacturer that have appropriate hardware performance is used. In our case it is a combination of Oculus Rift S and ZED mini from Stereolabs.





Figure 4. Headset for augmented reality

#### IV. CONCLUSION

The main goal of this paper was to understand the future of health architecture, i.e., to understand the guiding principles that contribute to the future development of hospitals and to recognize the importance of the implication of patients in the design process, i.e. to see the positive results of their interaction. and support in the design and design of clinical hospitals.

Through the phase of preliminary analysis, the needs and views of the patient, the focused care and the basic human need for social assistance and support indicate a number of positive results that have an impact on the whole society and its sectors.

The paper fully strives to improve the current state of such facilities and their role in society. It is clear that this architectural design solution cannot fully determine and anticipate all the needs, because the design of clinical hospitals is updated daily, but

still according to full research are aware of the main principles for future development that should be applied from the very beginning. design and which will contribute a huge number of positives not only to make a building look modern and beautiful, but above all to be fully functional and useful for those who use it, and additionally a huge positive side is that such a building will have contributions for the whole society and the environment in general. Therefore, with the help of this type of so-called new technology that offers an alternative reality, we can see all the disadvantages and advantages of building such facilities. At the same time, the development environment itself allows a lot of possibilities that with appropriate upgrades would allow an architect to even design in real time in augmented reality.

#### REFERENCES

- [1] Susana M. Vieira, and Joana B, (University of Minho, 4800-058 Guimaraes, Portugal Received 14 August 2013; Accepted 31 October 2013; Published 22 January 2014) Early Stage Design Decisions: The Way to Achieve Sustainable Buildings at Lower Costs Luís Bragança, Andrade Building Physics & Construction Technology Laboratory, School of Engineering,
- [2] James & James Science Publishers (London, UK, 1999) ECDGE (European Commission Directorate General XVII for Energy), A Green Vitruvius: Principles and Practise of Sustainable Architectural Design.
- [3] M. Deru and P. Torcellini, (in Proceedings of the 8th World Renewable Energy Congress and Expo, Denver, Colo, USA, 2004)“Improving sustainability of buildings through a performance-based design approach,”.
- [4] Hoјферт, Ернст. (2009). Архитектонско пројектирање, 39-то издание, Фивег+Гојбнер, Визбаден, Германија.

# Vehicle Routing Problem with Distance Constraints and Clustering Using MATLAB

D. Krstev\*, S. Dimitrov\*, A. Krstev\*\*

\*Faculty of Mechanical Engineering, University of Stip, Republic of N. Macedonia,

\*\*Faculty of Computer Science, University of Stip, Republic of N. Macedonia,  
sasko.dimitrov@ugd.edu.mk, dejan.krstev@ugd.edu.mk, aleksandar.krstev@ugd.edu.mk,

**Abstract:** The problem of designing routes for vehicles that should supply different customers with defined locations and specific demand from a single or various depots is known as the vehicle routing problem. The main objective in this case is minimizing the total cost of delivery or maximizing the profit while taking into consideration some constraints that vary from a case to another. In this paper I am going to define this problem, present a mathematical model to describe it, talk about the existing solutions to solve it, and use different tools to solve a real VRP of a company in tangier.

## I. INTRODUCTION

**Vehicle Routing Problem (VRP)** or a vehicle routing problem is illustrated by the figure below which shows a multi-node problem in which two vehicles have to make cargo deliveries to 11 stations and return to the warehouse or starting node. Cargo needs are in parentheses next to each node, and distances in kilometers are shown on the arcs. Initially, the 12-node is grouped into two groups, one for each vehicle. Nodes 2 to 6 are marked for vehicle 1, while nodes 7 to 12 are marked for vehicle 2. Node 1 is the starting node, warehouse. Practically, clustering takes into account physical barriers and obstacles, such as rivers, mountains, etc., as well as geographical areas such as cities that form a natural group. Capacity constraints and payloads are taken into account when grouping is developed. Thus, the payload of one vehicle is 45 t and of the other vehicle 35 t.

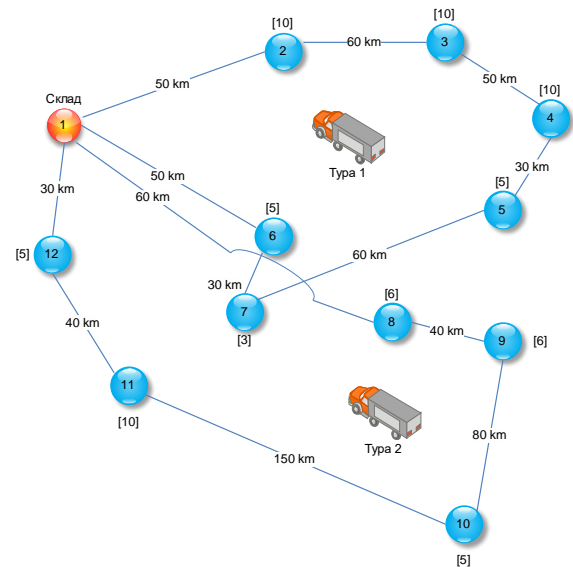

FIGURE 11. VEHICLE ROUTING PROBLEM: REVISED SOLUTION

## II. VEHICLE ROUTING PROBLEM (VRP)

**Vehicle Routing Problem (VRP)** or a vehicle routing problem is identical and extends the MTSP problem to include service requirements for each node at different vehicle capacities. The purpose of these problems is to minimize the total cost or distance across all routes.

TABLE 1. DISTANCE BETWEEN CITIES IN EASTERN MACEDONIA

	1	2	3	4	5	6	7
1		39	99	50	91	168	154
2	39		60	55	66	145	131
3	99	60		116	52	151	156
4	50	55	116		40	109	113
5	91	66	52	40		83	66
6	168	145	151	109	83		85
7	154	131	156	113	66	85	

The quantity of units of a new product L-Carnitine that is transported to individual cities in Eastern Macedonia is shown in Table 2, and the capacity of vehicles (K) is 5000 units.

TABLE 2. COALITIONS OF UNITS REQUIRED

i	(2) Kumano vo	(3) K. Palanka	(4) Veles	(5) Stip	(6) Delchevo	(7) Strumica
di	14 000	900	1 400	2 000	900	1 800

Sij savings are calculated and shown symmetrically with the following values in Table 11.

TABLE 3. THE ESTIMATED SAVINGS SIJ

	2	3	4	5	6	7
2		78	34	64	62	62
3	78		33	138	116	97
4	34	33		101	109	91
5	64	138	101		176	179
6	62	116	109	176		237
7	62	97	91	179	237	

Subordinated savings: [7,6], [7,5], [5,6], [5,3], [6,3], [4,6], [4,5], [7,3], [4,7], [3,2], [5,2], [6,2], [7,2], [4,2], [4,3].

First we consider the case for transport of the product from (7) Strumica to (6) Delchevo. They can be presented on the same route for the need of 2,700 units in a vehicle with a capacity of 5,000 units. A 7 → 6 connection is made, so nodes 7 and 6 will be neighbors of the route in the final solution.

Further we will consider the route from (7) Strumica to (5) Stip. If they are neighbors on the route it would be desirable to connect 6 → 7 → 5 or 5 → 7 → 6. The total number of units which is 4 700 in this route does not exceed the capacity of the vehicle (5000) Since the transported 4 700 units so far reach the capacity of the vehicles, the route of the first vehicle is completed.

We will review the route of the second vehicle in the nodes (3) Kriva Palanka and (2) Kumanovo. They can be presented in the same route because the required units for delivery are 1,400 and 900, ie 2,300 units, which fills the capacity of 5,000 units.

The next route is (4) Veles and (3) Kriva Palanka, which can be connected to the previous route 3 → 2, thus obtaining the desired route 4 → 2 → 3 or 3 → 2 → 4 with 3,700 units.

The delivery of the entire quantity of units (8400) for Eastern Macedonia is performed with two routes and two vehicles, namely 1 → 5 → 7 → 6 → 1 and 1 → 4 → 2 → 3 → 1. The total distance

traveled by the first vehicle is 408 km, while for the second vehicle it is 246 km.

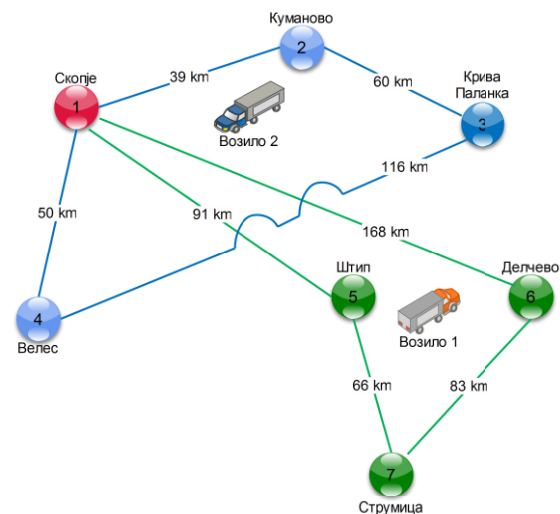

FIGURE 2. VEHICLE ROUTING PROBLEM FOR EASTERN PART OF NORTH MACEDONIA

The savings and quantities of delivered units of a new product with a quantity of 10 800 units in Western Macedonia, the route display and the number of vehicles are given in Tables 1, 2 and 3.

TABLE 4. DISTANCE BETWEEN CITIES IN WESTERN MACEDONIA

	1	8	9	10	11	12	13	14
1		131	176	174	159	67	44	112
8	131		47	106	32	108	132	62
9	176	47		66	52	124	146	78
10	174	106	66		138	107	132	61
11	159	32	52	138		140	164	62
12	67	108	124	107	140		24	46
13	44	132	146	132	164	24		70
14	112	62	78	61	62	46	70	

The quantity of units of a new product that is transported to individual cities in Western Macedonia, while the capacity of one vehicle (K1) is 7000 units and the second (K2) is 4000 units.

TABLE 5. COALITIONS OF UNITS REQUIRED

(8) Prilep	(9) Bitola	(10) Ohrid	(11) Krusevo	(12) Gostivar	(13) Tetovo	(14) Kicevo
1 600	2 000	2 000	1 200	1 200	1 600	1 200

Sij savings are calculated and displayed symmetrically with the following values in the table.

TABLE 61. THE ESTIMATED SAVINGS SIJ

Sij	8	9	10	11	12	13	14
8		260	199	258	90	43	181
9	260		284	283	119	146	210
10	199	284		205	134	86	225
11	258	283	205		86	39	209
12	90	119	134	86		87	133
13	43	146	86	39	87		86
14	181	210	225	209	133	86	

Subordinated savings: [9,10], [9,11], [8,9], [8,11], [10,14], [9,14], [11,14], [10,11], [8,10], [9,13], [10,12], [12,14], [9,12], [8,12], [12,13], [11,12], [13,14], [10,13], [8,13], [11,13].

First we consider the case for transport of the product from (9) Bitola to (10) Ohrid. They can be presented on the same route for the need of 4,000 units in a vehicle with a capacity of 7,000 units. A 9 → 10 connection is made, so nodes 9 and 10 will be neighbors of the route in the final solution.

Further we will consider the route from (9) Bitola to (11) Krushevo. If they are neighbors on the route it would be desirable to connect 10 → 9 → 11 or 11 → 9 → 10. The total number of units which is 5 200 in this route does not exceed the capacity of the vehicle (7000).

The next route with the greatest distance saving is (8) Prilep to (9) Bitola, if they are neighbors in the route it would be desirable to connect 10 → 9 → 8 → 11 or 11 → 8 → 9 → 10. As the 6,800 units transported so far approach the capacity of the first vehicle (7,000 units), the route of the first vehicle is completed.

We will review the route of the second vehicle in the nodes (12) Gostivar and (13) Tetovo. They can be presented in the same route because the required delivery units are 1,200 and 1,600, respectively 2,800 units.

The next route is (12) Gostivar and (14) Kicevo, which can be connected to the previous route 12 → 13, thus obtaining the desired route 13 → 12 → 14 or 14 → 12 → 13 with 4,000 units.

The delivery of the entire quantity of units (10 800) for Western Macedonia is done with two routes and two vehicles, and they are 1 → 10 → 9 → 8 → 11 → 1 or 1 → 11 → 9 → 8 → 10 → 1 and 1 → 14 → 12 → 13 → 1 or 1 → 13 → 12 → 14 → 1. The total distance traveled by the first vehicle is 455 km, while for the second vehicle it is 226 km.

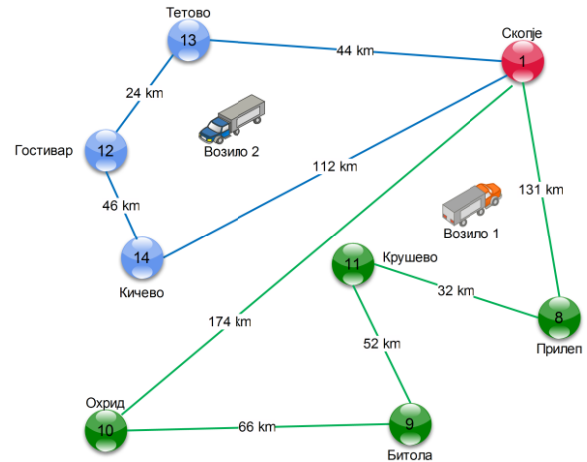

FIGURE 3. VEHICLE ROUTING PROBLEM FOR WESTERN PART OF NORTH MACEDONIA

### III. STEPS OF THE IMPLEMENTATION PROCESS

To explain the process, I am going to use the first cluster group to find the optimal route for the first vehicle.

The first thing to do is declaring the number of stations we have. In our first cluster, we have 8 stations (including the depot). Next, it is necessary to get an appropriate matrix; in order to do so, zeros (Number\_of\_Stations, 1) gives as a 12 by 1 matrix of zeros for both stations' longitudes and latitudes. Then, it is necessary to enter the coordinates of our given stations that will be used to fill our matrices using a for loop. The screenshot below shows the code part of what I just described.

```
Number_of_Stations = 12; %Declaration of the number of stations n = 1;
```

```
Stations_Longitude = zeros(Number_of_Stations,1); %Allocating x-coordinates
Stations_Latitude = Stations_Longitude; %Allocating y-coordinates
```

```
%Entering the coordinates of our given Stations
X = [-5.9206340,-5.839599,-5.824116,-5.809254,-5.9258994,-5.82757,-5.8627424,-5.8350188 ...]
Y=[35.7203120,35.73981,35.754001,35.753916,35.7359144,35.7500991,35.751059,35.7538851...]
```

```
%This loop fills the Matrices with the given Stations' coordinates for i=1:Number_of_Stations
Stations_longitude(i)=X(i);
STATIONS^LATITUTDE(i)=Y(i);
end
```

The next step is plotting the stations in their appropriate location using the given coordinates. For accurate visualization, it is necessary to import the real map. In order to do so, I used

'plot\_google\_map' that uses a code written and saved in the same file as the main code that generates information from google map.

Moving forward, we need to determine the possible paths, what I mean by this is the possible ways of selecting 2 stations from the 12 given stations. Since this is a combination, we have:  $C_n^k = \frac{n!}{k!(n-k)!}$ . With n=12 stations and k=2, we get 28 possible combinations between 2 stations (1-2, 1-3, 1-4...) Next, the distance between all the possible paths is calculated using the hypot function as follows:

```
Possible_paths=nchoosek(1:Number_of_Stations,2);
%Possible Combinations of 2 selected stations
display (Possible_paths)
%Distances calculation
Euclidean_distance -
hypot(Stations_latitude(Possible_paths(:,D)) -
Stations_latitude(Possible_paths(:,2)),
Stations_longitude(Possible_paths(:,D)) -
Stations_longitude(Possible_paths(:,2)));
len = length(Euclidean_distance);
display(Euclidean_distance)
```

The code fragment below shows the setting of the constraints and the use of the intlinprog function.

```
Aeq=spones(1:length(idxs));
beq=Number_of_Stations;

Aeq=[Aeq;spaUoc(Number_of_Stations,length)idxs),
Number_of_Stations*(Number_of_Station12-1)];
for ii = 1:Number_of_Stations
    whichidxs = (idxs == ii);
    % find the trips that include stop ii
    whichidxs = sparse(sum(whichidxs,2));
    % include trips where ii is at either end
    Aeq(ii+1,:) = whichidxs';
    % makes sure to include the constraint
matrix
End

beq = [beq; 2*ones(Number_of_Stations,1)];
intcon = 1:len;
lb = zeros(len,1);
ub = ones(len,1);

Distance_Limit=40;
%This is my inequality constraint
opts = optimoptions('intlinprog','Display','off');
```

```
[x_tsp,costopt,exitflag,output]
intlinprog(Euclidean_distance,intcon,Euclidean_dist
ance,Distance_Limit,Aeq,beq,lb,ub,opts);
```

Moving forward, there is another very important point to consider while programming which are the subtours eliminations. When I run the program the first time, the result I got was a set of non-linked tours. In order to avoid this, it is necessary to add a part in the code to eliminate the subtours. You can see in the appendix in the code part, the section where the subtours are eliminated.

Since I used longitude and latitude as coordinates. The calculated distance is Euclidean. In order for me to know the distance in Kms to compare it with the optimal tour length generated by the other tools, I simple multiplied the decision variables vector with the distance vector. The fragment code below shows this step (since the distance vector is long it doesn't totally appear):

```
%Calculation of total distance in Kms
first_cluster_distances=[9.198,11.25,13.996,8.392,1
0.506,8.316,10.158,2.921,6.278,14.818,2.177,3.727,
2.441,8.11,15.8..]
Optimal_route=First_cluster_distances*x_tsp;
display(Optimal_route)

display(x_tsp)
:title('Solution for 8 stops with subtours eliminated');
hold off

lisp(output.absolutegap)
```

#### IV. RESULTS AND CONCLUSION

The total length of the optimal route generated and with the following route in order:

Looking at the solutions for routing the vehicle in Eastern Macedonia I can create a complete tour 1 → 2 → 4 → 5 → 7 → 6 → 3 → 1 whose length is 535 km. Since this method does not always give the optimal value of the tour, I reviewed the network again with the help of a software tool and found a better tour, such as 1 → 4 → 6 → 7 → 5 → 3 → 2 → 1. The total distance of this tour is 461 km, compared to the previous one of 535 km, or a difference of 48 km.

Looking at the solutions for routing the vehicle in Western Macedonia I can create a complete tour 1 → 13 → 12 → 14 → 10 → 9 → 8 → 11 → 1 whose length is 479 km. Since this method does not always give the optimal tour value, I reviewed the network again and found a better tour, such as 1 → 13 → 12 → 14 → 10 → 9 → 11 → 8 → 1. The total distance

of this tour is 456 km, compared to the previous one of 479 km, or a difference of 23 km.

#### REFERENCES

- [1] Daneshzand F, The Vehicle-Routing Problem, Elsevier, 2011,127.
- [2] Christofides N, The vehicle routing problem, Numdam, 56.
- [3] Sahbi B I, Legras F, Coppin G, Synthèse du problem de routage de véhicule,telecom Bretagne, 7
- [4] Mais H R, Wahiba R C, Bloch C, Classification de problemes de tournées de vehicules, 2008.

# Application of the MQTT Protocol in Telepresence Robots

A. Velinov\*, N. Koceska\*, S. Koceski\*

\*Faculty of Computer Science, University Goce Delchev - Shtip, Republic of North Macedonia

**Abstract** – This paper presents the application of the MQTT protocol in the communication with telepresence robots. They are used for various purposes in education, medicine, nursing homes, etc. To ensure a good user experience, sending data from applications to telepresence robots needs to be fast and reliable. The MQTT protocol is open, fast and can be easily implemented. Its features make it ideal for data transmission in the communication with telepresence robots.

## I. INTRODUCTION

Telepresence robots (TRs) are special type of robot used to provide a view in remote locations through proper control and movement in the environment. These robots often have a built-in teleconferencing system, camera, speakers, microphones and so on. Most of them also have wheels for movement in the environment in which they are located. This allows the user at the remote location to control the robot depending on its needs. TRs can also be operated by people at the location of the robot if remote people are unable to do that.

The benefits of using these types of robots are huge. There are a lot of use cases in which TRs can be used. According to one research of UNESCO Institute for Statistics (UIS), the number of children, adolescents and youth out of school in 2018 was 258 million. Of these, 59 million were primary school children, 62 million were lower secondary school children and 138 million were upper secondary school [2]. Due to the situation with the Covid-19 virus, this number is now significantly higher. With the proclamation of the pandemic on 11 March 2020 by World Health Organization (WHO), many schools and universities were closed. The educational process started online with the use of teleconferencing platforms. Given the situation, it is good that the educational process has continued. This was primarily due to the digitalization as well as new technological developments. This only confirms the need for investments in new platforms, tools and things that will be able to facilitate the educational process in the future [5] [30]. TRs can be used for this. Using them in education can help both children and teachers. They can help all children who, for some reason, cannot attend school. This

way they would feel like they were really present in the classroom. This increases the sense of belonging and at the same time motivates the students. As mentioned earlier, TRs can also help teachers. They also face problems during the teaching process. This is especially pronounced now in a time of pandemic. One of the biggest problems they face is in terms of practical work and laboratory exercises. Although they can use computer cameras, they do not always provide a good view. This is where TRs can help. They can provide access, from different angles, to any place in the room, e.g. a large laboratory where practical work is performed. A better view can be made possible by moving the robot properly and zooming in using the camera. Using additional technology such as augmented and virtual reality can also enhance the TRs user experience [4]. This confirms the importance of using TRs in education [1] [3].

TRs can also be used in health care. According to one study of United Nations (UN) for the world population, there were 703 million elderly people that are on age 65 and over in the world in 2019 [6]. It is estimated that the number of elderly people will double by 2050 to 1.5 billion [6]. This imposes the need to develop new technologies and platforms that will help the elderly to perform daily activities. These technologies would certainly be of great help to caregivers who also face new challenges on a daily basis. TRs can have a huge positive impact acting as an assistant to caregivers [7]. With TRs, caregivers will be able to monitor the elderly remotely. Elderly people can communicate with their family members and their friends, which will reduce loneliness and maintain social interactions. TRs will especially help when people are in a nursing home, where the communication, support and inclusiveness are most important [8].

There are several use cases for TRs in medicine. They can be used as a communication tool between patients and their families and doctor, for remote health consultation, for contactless delivery of foods and medicines, for remote room disinfection [9] etc. These things are extremely important, especially now, in the period of the Covid-19 pandemic.

All of the above use cases only confirm the importance of using TRs. What is also important in TRs is the communication. Sending commands from a remote user to the TRs should be almost in real-time with low latency. This can be achieved using the MQTT protocol.

The rest of the paper is structured as follows: Section II presents the related work with MQTT and TRs. Section III describes the basics of the MQTT protocol. Section IV presents the application of the MQTT protocol in TRs. Section V is a discussion about the TRs and MQTT. Section VI is a conclusion of our work.

## II. RELATED WORK

Gonzalez-Jimenez in [10] describe the usage of TRs in elder telecare applications. They proposed the MQTT protocol for sending commands to the robot and also for exchanging sensorial data. Cymbalak et al. in [11] present a concept of extending the telepresence technology with physical interactions. They proposed integration of MQTT in overall communication model for sending coordinates, pressure data, body or instructions for arm movement with minimal delay. Kiselev et al. in [12] present an evaluation of using semi-autonomy features in telepresence systems. In their robot control architecture, they have used the MQTT protocol for communication with the client interface. Loza-Matovelle et al. in [13] proposed an architecture for integration of robots and sensors for the elderly in an ambient assisted living environment. In this architecture MQTT is used for communication between devices which contain sensor and actuators. Cortellessa et al. in [14] used the MQTT protocol for inter-process communication which allowed sharing data by using a publish/subscribe design pattern. Luperto et al. in [15] showed a framework which is centered around an assistive mobile robot for elderly people. They proposed the usage of MQTT protocol for communication purposes. The same authors in [16] show the main components of the system with mobile robot for at-home ambient assisted living of the elderly. In their system the robot interacts with other system components by sending commands and feedback through a MQTT channel using JSON messages. Melendez-Fernandez et al. in [17] present a web-based solution for robotic telepresence. They used MQTT protocol for establishing a bidirectional communication between clients and robots. MQTT

is used for sending commands to the robot and transmitting sensory data. For this purpose, they used a MQTT Message Broker which implements the MQTT protocol and provides compatibility for TCP/IP and WebSockets.

The MQTT protocol is also used in automotive industry for data transmission, in transport and logistics, in telecommunications and in manufacturing industry. Car manufacturer company BMW uses MQTT to create fast, reliable and scalable platform for cars [19]. It uses this protocol in their car-sharing application. SAIC Volkswagen uses MQTT in their IoV platform that establishes the connection between cars, cars and people, cars and roads. It also implements in-car information services, intelligent transportation and vehicle control automation [20]. Matternet uses MQTT for real-time monitoring of autonomous drones [21]. The drones and the landing stations transmit MQTT messages that can be used to provide the flight status in real-time. In some of the IBM Telemetry use cases, the MQTT protocol is used for home energy monitoring and control and for home patient monitoring [22] [23]. CASO Design uses MQTT for creating smart kitchen appliances. This protocol helps them to enable remote management of the appliances and for pushing notifications for the end-users to inform them about unexpected situations [24]. German Railway uses MQTT to enable the communication between the trains and wayside monitoring systems [25]. Facebook Messenger has been using MQTT since 2012 [26]. It enabled fast messaging as well as optimization of battery and bandwidth. The transmission of messages took place in hundreds of milliseconds, instead of a few seconds like earlier. All of these use cases only confirm the benefits of using the MQTT. This protocol can be applied to improve the communication in TRs, both for sending commands and for proper exchange of data.

## III. MQTT PROTOCOL BASICS

MQTT is a publish/subscribe protocol for the Internet of Things (IoT) [18]. It is located at the application layer of the IoT protocol stack. It is open, simple and can be easily implemented. These features make it useful for constrained devices which has limited memory and low processing power such as sensor devices and controllers. There are libraries for application development that use the MQTT protocol in several programming languages such as: C, Java, C#, JavaScript, etc.



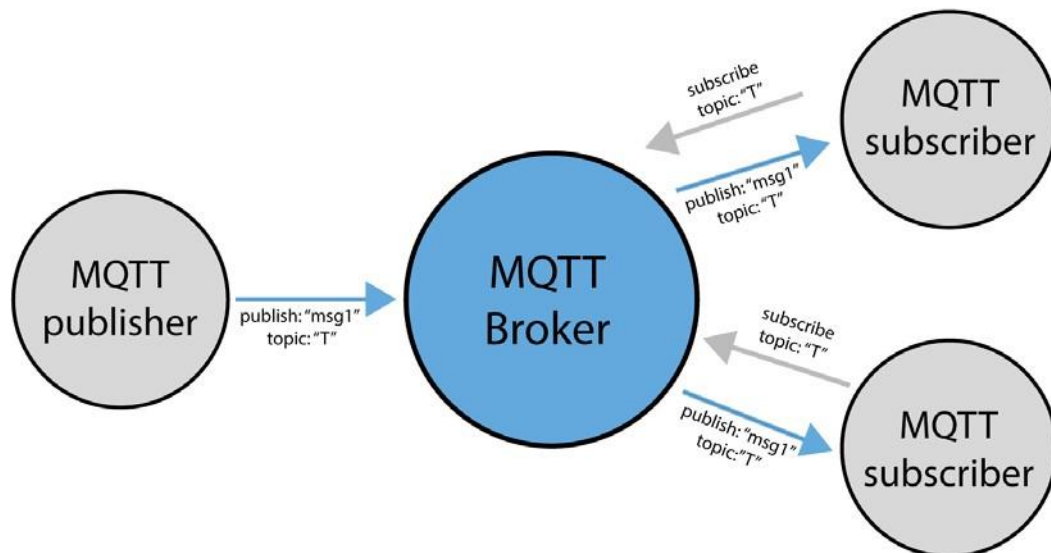

Figure 1. MQTT publish-subscribe model

In 2014 the version 3.1.1 of the MQTT became OASIS standard, while in 2016 it became ISO standard. The latest version of the protocol is MQTT

5.0. It became OASIS standard in 2019. It offers a number of improvements and new features that can help the clients.

This protocol implements the publish/subscribe model which is ideal for IoT communication (Fig. 1). It is client-server model with two types of clients. The first type are clients who send messages which are called publishers. The second type of clients are those who subscribe on a specific topic to receive messages. They are called subscribers. The central role in this communication is played by the broker. It receives all the messages from publishers and delivers them to subscribers according to the topic on which they have subscribed. These two types of clients do not communicate directly with each other. The broker is acting as an intermediary between them.

The topic is hierarchically arranged UTF-8 string which is the subject of the message. It can have one or more levels which are separated by the character “/”. One example of MQTT topic is:

```
/home/bedroom1/temperature
```

This topic has three levels. Topic names are case sensitive, so the following topic is not the same as the previous:

```
/home/Bedroom1/temperature
```

MQTT has three Quality of Service (QoS) levels which guarantee delivery of messages. The QoS levels are:

- QoS 0 (at most once)
- QoS 1 (at least once)
- QoS 2 (exactly once)

MQTT v.3.1.1 has 14 different control packets (CONNECT, CONNACK, PUBLISH, PUBACK, PUBREC, PUBREL, PUBCOMP, SUBSCRIBE, SUBACK, UNSUBSCRIBE, UNSUBACK, PINGREQ, PINGRESP and DISCONNECT. The

latest version MQTT 5.0 has one packet more and it is the AUTH control packet. Every packet has a size between 2B and 256MB. It is ideal for networks for low bandwidth and high latency. According to [27] the average latency is around 0.3196 seconds. It is especially important for applications where we need to exchange data in real time. TRs are the ones that require communication in almost real time. This is especially true for the robot movement commands. In order for the robot to move smoothly, the commands sent by a client need to be delivered with low latency and almost in real time. In addition to the commands, the data itself should be sent quickly. This can be data from sensors placed on the robot, data from the environment, etc. According to its features, the MQTT protocol can significantly help to improve the communication in TRs.

#### IV. THE USE OF THE MQTT PROTOCOL IN TRS COMMUNICATION

TRs are usually located in a remote environment. Users send commands to the robot that receives the commands and responds accordingly. Commands are sent over the Internet. In order to have natural movements, it is important that the commands sent by remote users are sent in fairly real time. If this is not the case, then we would have a bad user experience. Users will try to move the robot, but due to the delay of the commands, they could not fully

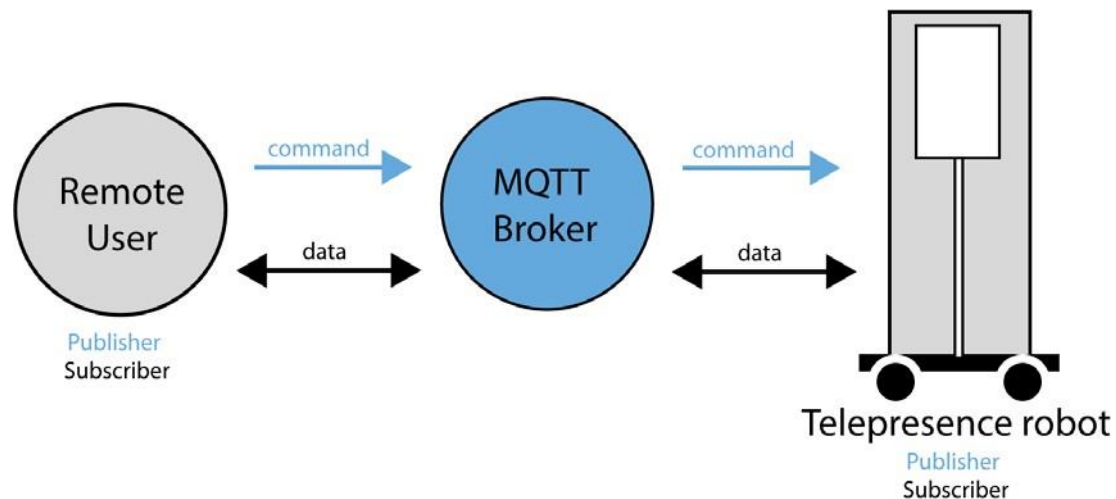

Figure 2. Communication of user and telepresence robot using the MQTT protocol

follow it. Since the user is not in the same room as the robot, he/she uses a network to send data/commands. Network issues can also be a problem for properly delivering commands to the robot. However, this is a general problem and the user is usually notified about this through the application he/she uses. There are TRs which have tablets or mobile phones attached to them, that serve to establish a connection with the robot. Basically, the commands that are sent by the user to this mobile device are forwarded to the robot which executes them. Forwarding commands in this case must also be done quickly in order to ensure a good user experience. In addition to commands, we often need to send data from the robot to the users and vice versa (this may be data from sensor device located on the robot, data for objects located in the environment, some private data etc.). Adequate fast and reliable transport should also be provided for this data. This will also provide a good user experience.

According to its characteristics, the MQTT protocol can be applied for communication in TRs. As can be seen in Figure 2, the remote user and the telepresence robot communicate with each other using the MQTT protocol and MQTT broker as a central component of the architecture. To send commands, the remote user sends a message to the broker, on a topic on which the telepresence robot is subscribed. Once the broker receives the message, it forwards it to the robot that executes the command. Sending data can be in both directions, from the remote user to the telepresence robot and vice versa.

## V. DISCUSSION

A very important thing in developing applications for TRs using the MQTT protocol is to determine the purpose of the application, in order to determine the data flow. Depending on the context of the application, the telepresence robot can have the role

of publisher and subscriber. Same is for the client. The data and commands are sent through MQTT broker.

As mentioned before, that MQTT has three levels of QoS. To develop application, we need to determine which QoS level we will use. It all depends on the purpose of the application: whether we want the messages to be sent at most once (QoS 0), at least once (QoS 1) or exactly once (QoS 2).

Another important thing when we develop applications for TRs using the MQTT protocol is to pay attention to the security. Appropriate authentication and authorization mechanisms must be provided in order to allow only users who have the appropriate rights to send commands to the robot and to exchange data. If data are sensitive, then it is best to encrypt it or the transmission could be through covert channels suggested in [28] and [29].

## VI. CONCLUSION

TRs can be used in a variety of fields. They can be used in education, medicine, homes, care centers for elderly, museums, etc. Therefore, it is important to implement appropriate mechanisms and protocols that will ensure reliable and fast data transfer. This can be achieved by implementing the MQTT protocol. It is open, simple and can be easily implemented. Sending messages with MQTT is done almost in real time. All of this makes it ideal for TRs communication. Our future research will be focused on developing applications for TRs using the MQTT protocol.

## REFERENCES

- [1] Cha, E., Chen, S., & Mataric, M. J. (2017, August). Designing telepresence robots for K-12 education. In 2017 26th IEEE International Symposium on Robot and Human Interactive Communication (RO-MAN) (pp. 683-688). IEEE.
- [2] UNESCO Institute for Statistics (UIS). New Methodology shows that 258 Million Children, Adolescents and Youth are Out of School. 2019, Fact sheet 56. UIS/2019/ED/FS/56.

- Available online:  
<http://uis.unesco.org/sites/default/files/documents/new-methodology-shows-258-million-children-adolescents-and-youth-are-out-school.pdf> (accessed on 18 October 2021).
- [3] Velinov, A., Koceski, S., & Koceska, N. (2021). A REVIEW OF THE USAGE OF TELEPRESENCE ROBOTS IN EDUCATION. *Balkan Journal of Applied Mathematics and Informatics*, 4(1), 27- 40.
- [4] Timovski, R., Koceska, N., & Koceski, S. (2020). The use of Augmented and Virtual Reality in Education. In: *International Conference on Information Technology and Development of Education –ITRO, Zrenjanin, Serbia*.
- [5] Koceska, N., Koceski, S., Pucovski, B., Mitkovska, V., & Lazovski, A. (2020). Investigating the Effects of Online and Flipped Classroom Approach during COVID-19 Pandemic.
- [6] United Nations Department of Economics and Social Affairs. *World Population Ageing*. 2019. Available online: <https://www.un.org/en/development/desa/population/publications/pdf/ageing/WorldPopulationAgeing2019-Highlights.pdf> (accessed on 19 October 2021).
- [7] Koceska, N., Koceski, S., Beomonte Zobel, P., Trajkovik, V., & Garcia, N. (2019). A telemedicine robot system for assisted and independent living. *Sensors*, 19(4), 834.
- [8] Reis, A., Xavier, R., Barroso, I., Monteiro, M. J., Paredes, H., & Barroso, J. (2018, June). The usage of telepresence robots to support the elderly. In *2018 2nd International Conference on Technology and Innovation in Sports, Health and Wellbeing (TISHW)* (pp. 1-6). IEEE.
- [9] Wang, M., Pan, C., & Ray, P. K. (2021). Technology Entrepreneurship in Developing Countries: Role of Telepresence Robots in Healthcare. *IEEE Engineering Management Review*, 49(1), 20-26.
- [10] Gonzalez-Jimenez, J., Galindo, C., Melendez-Fernandez, F., & Ruiz-Sarmiento, J. R. (2013, July). Building and exploiting maps in a telepresence robotic application. In *10th international conference on informatics in control, automation and robotics (ICINCO)*.
- [11] Cymbalak, D., Jakab, F., Szalay, Z., Turmň, J., & Bilský, E. (2019, November). Extending Telepresence Technology as a Middle Stage between Humans to AI Robots Transition in the Workplace of the Future. In *2019 17th International Conference on Emerging eLearning Technologies and Applications (ICETA)* (pp. 133-138). IEEE.
- [12] Kiselev, A., Kristoffersson, A., Melendez, F., Galindo, C., Loutfi, A., Gonzalez-Jimenez, J., & Coradeschi, S. (2015, July). Evaluation of using semi-autonomy features in mobile robotic telepresence systems. In *2015 IEEE 7th International Conference on Cybernetics and Intelligent Systems (CIS) and IEEE Conference on Robotics, Automation and Mechatronics (RAM)* (pp. 147-152). IEEE.
- [13] Loza-Matovelle, D., Verdugo, A., Zalama, E., & Gómez-García- Bermejo, J. (2019). An architecture for the integration of robots and sensors for the care of the elderly in an ambient assisted living environment. *Robotics*, 8(3), 76.
- [14] Cortellessa, G., Fracasso, F., Sorrentino, A., Orlandini, A., Bernardi, G., Coraci, L., ... & Cesta, A. (2016, June). Enhancing the interactive services of a telepresence robot for AAL: Developments and a psycho-physiological assessment. In *Italian Forum of Ambient Assisted Living* (pp. 337-357). Springer, Cham.
- [15] Luperto, M., Javier, M., Francisco-Angel, M., Ruiz-Sarmiento, J. R., Basílico, N., Javier, G., & Borghese, N. A. (2018). A multi- actor framework centered around an assistive mobile robot for elderly people living alone. In *Robots for Assisted Living Workshop-International Conference on Intelligent Robots and Systems (IROS)*.
- [16] Luperto, M., Monroy, J., Ruiz-Sarmiento, J. R., Moreno, F. A., Basílico, N., Gonzalez-Jimenez, J., & Borghese, N. A. (2019, September). Towards long-term deployment of a mobile robot for at-home ambient assisted living of the elderly. In *2019 European Conference on Mobile Robots (ECMR)* (pp. 1-6). IEEE.
- [17] Melendez-Fernandez, F., Galindo, C., & Gonzalez-Jimenez, J. (2017). A web-based solution for robotic telepresence. *International Journal of Advanced Robotic Systems*, 14(6), 1729881417743738.
- [18] MQTT. MQTT: The standard for IoT Messaging. Available online: <https://mqtt.org/> (accessed on 21 October 2021).
- [19] HiveMQ. Using MQTT and HiveMQ to Build the Connected Car. Available online: <https://www.hivemq.com/blog/creating-the-connected-car-platform/> (accessed on 21 October 2021).
- [20] EMQ. EMQ helps SAIC Volkswagen building IoV platform. Available online: <https://www.emqx.com/en/blog/emqx-in-volkswagen-iov> (accessed on 21 October 2021).
- [21] HiveMQ. HiveMQ's Reliable IoT Communication Enables Real-time Monitoring of Matternet's Autonomous Drones. Available online: <https://www.hivemq.com/case-studies/matternet/> (accessed on 21 October 2021).
- [22] IBM. Telemetry use case: Home energy monitoring and control. Available online: <https://www.ibm.com/docs/en/ibm-mq/8.0?topic=cases-telemetry-use-case-home-energy-monitoring-control> (accessed on 21 October 2021).
- [23] IBM. Telemetry use case: Telemetry use case: Home patient monitoring. Available online: <https://www.ibm.com/docs/en/ibm-mq/8.0?topic=cases-telemetry-use-case-home-patient-monitoring> (accessed on 21 October 2021).
- [24] HiveMQ. CASO Design creates Smart Kitchen Appliances with HiveMQ. Available online: <https://www.hivemq.com/case-studies/caso/> (accessed on 21 October 2021).
- [25] Eclipse IoT. Deploying IoT on Germany's DB Railway System. Available online: <https://iot.eclipse.org/community/resources/case-studies/iot-on-railway-systems-db/> (accessed on 21 October 2021).
- [26] Facebook Engineering. Building Facebook Messenger. 2011. Available online: <https://engineering.fb.com/2011/08/12/android/building-facebook-messenger/> (accessed on 21 October 2021).
- [27] Atmoko, R. A., & Yang, D. (2018, August). Online monitoring & controlling industrial arm robot using mqtt protocol. In *2018 IEEE International Conference on Robotics, Biomimetics, and Intelligent Computational Systems (Robionetics)* (pp. 12-16). IEEE.
- [28] Velinov, A., Mileva, A., Wendzel, S., & Mazurczyk, W. (2019). Covert channels in the MQTT-Based Internet of Things. *IEEE Access*, 7, 161899-161915.
- [29] Mileva, A., Velinov, A., Hartmann, L., Wendzel, S., & Mazurczyk, W. (2021). Comprehensive analysis of MQTT 5.0 susceptibility to network covert channels. *computers & security*, 104, 102207.
- [30] Davcev, K., Koceska, N., & Koceski, S. (2019). A review of robotic kits used for education purposes. In: *International Conference on Information Technology and Development of Education –ITRO, Zrenjanin, Serbia*.

# Creating 3D Objects Using Photogrammetry

R. Timovski\*, S. Koceski\*, N. Koceska\*

\*Faculty of Computer Science, Goce Delcev University - Stip, Republic of North Macedonia

**Abstract:** Nowadays there is an increasing demand of creating accurate 3D models of various object. Visualization of these models allows the user to get the realistic impression of the object. 3D visualization has many applications in the areas of architecture, engineering, medicine, tourism, education etc. This paper presents the creation of 3D objects using photogrammetry technique. During our research, we have generated 3D model of various small objects. However, the focus was on generating 3D model of a human body, using Meshroom software. The lessons learned, during the data acquisition, as well as 3D reconstruction are presented in this study.

**Keywords:** photogrammetry, 3D reconstruction, 3D model, Meshroom.

## I. INTRODUCTION

One of the many lessons learned during Covid-19 pandemic, is the need to incorporate technology into education systems. This require reorganizing teaching and learning processes, by creating flexible and enriched educational environments, that will help teachers in conducting the teaching activities, while increasing students' motivation and engagement, at the same time. The transformation of teaching and learning by the utilisation of technologies has certainly provided an exciting opportunity to design various learning systems and environments, that are realistic, engaging and fun [1, 2, 3, 4, 5, 6].

Nowadays, one of the technologies that is showing great potential in education system is Augmented Reality (AR). Using AR technology in education has a number of advantages. AR can: significantly improve students' level of content knowledge, enhanced engagement, enjoyment, motivation and participation improve students' outcome, promote exploratory behavior and develop a positive attitude [7]. The advantages of AR in education indicates that there is good potential to integrate AR in teaching and learning, especially for the subjects that require the students to visualize. The virtual objects used in AR, appear to coexist in the same space of the objects in the real world. Augmented reality (AR) combines real and virtual world, supplementing the real world

with computer-generated virtual objects in real-time [8, 9]. AR uses pre-determined target points in real world by connecting virtual objects and interpreting the results through certain programs. However, the virtual

objects used in AR, should be created previously, using various technique and specific computer programs.

This paper presents the creation of 3D objects using photogrammetry technique. During our research, we have generated 3D model of various small objects (like vase, ceramic glass, little statue etc.) However, the main focus of this paper is generating 3D model of a human body. For photo processing we used Meshroom - an open source software 3D reconstruction software based on the AliceVision framework [10]. To clean up and refine our 3D mesh, Meshlab software is used [11].

## II. WHAT IS PHOTOGRAMMETRY?

Photogrammetry is a technique to obtain reliable data of real-world objects in the environment by creating 3D models from photos [12]. The technology is practically as old as the photography itself. During the years, it has evolved from analog optical-mechanical technique to analytical methods based on computer/software applications involving complex mathematical algorithms and finally, nowadays, to digital photogrammetry based on digital imagery and computer vision. Photogrammetry is primarily concerned with making precise measurements of three-dimensional objects and terrain features from two-dimensional photographs. Photos should be taken from different positions and angles, allowing for appropriate calculations. 2D and 3D data is extracted from an image and, with overlapping photos of an object, building, or terrain, converted into a digital 3D model.

The fundamental principle used by photogrammetry is triangulation. A line of sight (or ray) can be constructed from the camera location to the point on the object. It is the intersection of these rays that determines the three-dimensional location of the point [12].

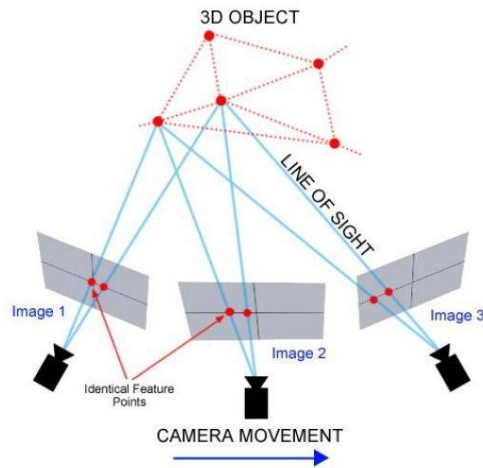

Figure.1 The concept of photogrammetry

### III. TYPES OF PHOTOGRAMMETRY

Photogrammetry can be classified based on camera location during photography. On this basis we have aerial, terrestrial (or Close-Range) and space photogrammetry [13].

In aerial photogrammetry, the camera is mounted in an aircraft (or drone or unmanned aerial vehicles-UAVs) and is usually pointed vertically towards the ground. Multiple overlapping photos of the ground are taken as the vehicle flies along a flight path. Traditionally these photos were processed in a stereo-plotter (an instrument that lets an operator see two photos at once in a stereo view) but now are often processed by automated desktop systems. The photogrammetry software will take the images (and potentially GPS position data, along with any camera information or calibration) from the flying vehicle and produce a set of 3D points or surfaces that describe the surface (the ground or object) being modeled.

In terrestrial photogrammetry, the camera is located on the ground, and hand-held, tripod or pole mounted. Usually this type of photogrammetry is non-topographic - that is, the output is not topographic products like terrain models or topographic maps, but instead drawings, 3D models, measurements, or point clouds. Everyday cameras are used to model and measure buildings, engineering structures, forensic and accident scenes, mines, earthworks, stock-piles, archaeological artifacts, film sets, etc. In the computer vision community, this type of photogrammetry is sometimes called Image-Based Modeling.

One step forward from aerial and terrestrial photogrammetry is space photogrammetry (photogrammetry on large scale). It is conducted with cameras that are positioned on the Earth

surface or on a satellite. It is used in space exploration, for mapping the space around us, giving accurate information

about cloud patterns, producing more accurate maps of the Earth itself and the objects positioned into the space.

#### A. Classification of photos

Aerial photographs can be classified in to two main categories: vertical photographs and tilted photographs. Vertical photographs are done when the camera axis is strictly vertical. The lens of the camera is pointed down to the ground (bird-eye view). Most common approach for this type of pictures is when the camera is put on a drone or airplane. When pictures are taken with camera axis near (but not fully) vertical or when the camera axis is unintentionally tilted from the vertical (while positioned on a drone or airplane) we speak about tilted photos. If tilt of the camera axis from the plumb line is less than 3 degree the photograph is called vertical. For tilt more than 3 degree, it is called tilted photograph. Tilted photograph may again be classified in two categories: high oblique - in which the apparent horizon appears, and low oblique - in which the apparent horizon does not appear (Fig. 1).

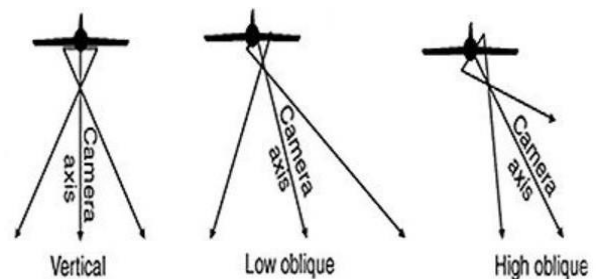

Figure 2. Aerial photography principles

When applying photogrammetry on a small sized object, the possibility to choose among different acquisition strategies is one of the greatest advantages. Several important factors have to be considered in this scenario. The shape and geometry of the object is very important. Thus, it is necessary to calculate two very important parameters: tilt angle ( $\Psi$ ) and step angle ( $\theta$ ) values. Tilt angle identifies the inclination of the camera respecting the xy object plane. Step angle identifies the rotational angle step when turning around the object and within the same tilt angle determines the number of images taken. It also determines how much the images will overlap between each other (bigger step angle – smaller overlapping).

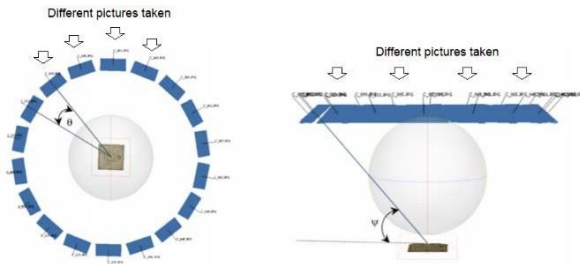

Figure 3. Step and Tilt angle

In general, if photogrammetry software application is available, several steps need to be followed in order to build a 3D model of an object using photogrammetry:

1. Photo acquisition - taking photos from different angles, following the prerequisites for photo shooting;
2. Processing of photographs - loading the images into the photogrammetry software;
3. 3D Model generation - choosing the method, if it is not automatically, and setting the features of the software application before processing the images;
4. Texturing and visualization.

#### IV. PHOTOGRAMMETRY OF A HUMAN BODY

The focus of this case study is generating 3D model of a human body. The human body is one of the most complicated objects to model because of its complex features, non-rigidity, and the time required to take body measurements. In body scanning, large errors occur due to the non-static nature of the human body and to the occurrence of displacements during the scanning process, such as small movements, breathing, and blinking. For example, just during quiet breathing in healthy subjects, the breathing amplitude is one-third of a deep breath (approximately 3 cm) based on the average 3D distances of the chest and abdominal wall [14]. To avoid large errors, the scanning time has to be as short as possible, in order to freeze the scene.

##### B. Methodology

The methodology used in this research includes several steps with different degrees of automation: 1) photo-capturing in short-time intervals with minimum light variation (indoor); 2) denoising; 3) edges improvement; 4) determination of matching features/points (characteristic points); 5) generating mesh.

Steps 2-5 are integrated and automated within Meshroom processing nodes scheme. For the fourth step, FeatureExtraction node was included in the processing, working with Scale-Invariant Feature

Transform (SIFT) algorithm, while DescriptorPreset value was set to High.

Multiple scenarios were conducted in slightly different conditions (outdoor - with indirect lighting, as well as indoor scenarios - with different lighting conditions). These scenarios were also applied on other small objects (like vase, ceramic glass, little statue etc.) in order to draw certain conclusions. Ten scenarios used in this research are shown in Table1.

Table1. Scenarios used in the research

N	Dataset	Node structure	N of p	Processing time	I/O
1	Male_1	General scheme	74	53 minutes	Outdoor
2	Female_1	General scheme	80	51-52 minutes	Indoor
3	Female_1	General scheme +: 1. Camera sensor width added to sensor db 2. Denoising filter (node) included 3. Decimate node included	80	53-54 minutes	Indoor
4	Female_2	Out of the box nodes + additionally: 1. Camera sensor width added to sensor db 2. Feature extraction / Descriptor preset = High	103	93 minutes	Indoor
5	Female_3	General scheme	47	61 minutes	Indoor
6	Female_3	General scheme _: 1. FeatureExtraction / DescriptorPreset = High 2. MeshDenoising node included	47	78 minutes	Indoor
7	Female_4	General scheme	64	65 minutes	Indoor
8	Male_5	General scheme + additionally: 1. FeatureExtraction / DescriptorPreset = High 2. MeshDenoising node included	92	91 minutes	Indoor
9	Male_6	General scheme + additionally: 1. FeatureExtraction / DescriptorPreset = High 2. MeshDenoising node included	103	110 minutes	Indoor
10	Male_7	General scheme + additionally: 1. FeatureExtraction / DescriptorPreset = High	155	98 minutes	Indoor

General scheme includes nodes shown on Fig. 4.

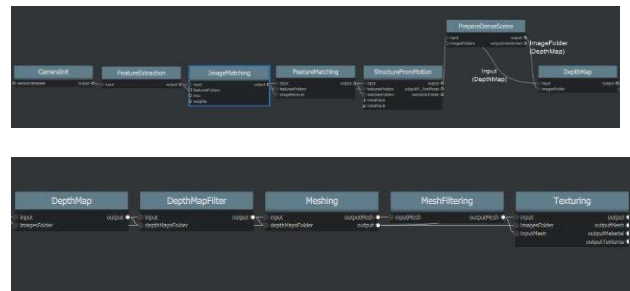

Figure 4. General node scheme

The technical details about the hardware and software used in this research are as follows:

- **Camera:** Samsung S9, sensor size: 1/2.55"
- **Computer:** Intel(R) Core(TM) i7-7700U CPU @ 4.20GHz 4.20 GHz , RAM: 16GB / NVIDIA GeForce GTX 1060 6GB. As for hardware requirements, the Nvidia GPU (with compute capability of at least 2.0) is generally required for the dense high quality mesh generation. 32GB of RAM is recommended for the meshing. Of course, it can run with lower parameters also, but it will increase the processing time.

- **Operating system:** Windows 10 64x86.
- **Photogrammetry software:** Meshroom 2020.1.1.
- **3D editing software:** Meshlab.

*C. Data acquisition*

Photographs of the subjects were mainly taken indoor, in an empty room with white walls and indirect solid daylight. Photographs were taken from different angles around the subjects. The positions of the camera were carefully planned for the geometric accuracy of photogrammetric reconstruction of the project and to identify all points on photographs required for determination of the frame of reference and textural data of the object.

Dataset samples, for different subjects and scenarios, are shown on Fig. 5 – Fig. 7

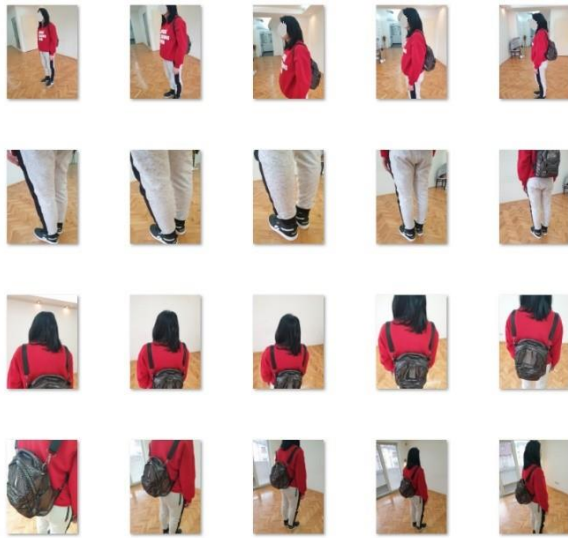

Figure 5. Scenario\_3 Part of Dataset Female\_1



Figure 6. Scenario\_6 Part of Dataset Female\_3



Figure 7. Scenario\_10 Part of Dataset Male\_7

*D. Creating the 3D Models and post procesing*

The photos, taken by each subject, were imported into Meshroom software, where 3D models were generated. However, these 3D models have a lot of noise, holes, and irregularities that need to be clean up. For this purpose, MeshDenoise and MeshDecimate functions were used. MeshDenoise removes the noise from the meshes, while MeshDecimate reduces the vertex density of a mesh by removing and reconnecting vertices automatically while attempting to preserve the mesh's silhouette and normals as much as possible.

The remaining unwanted artifacts were removed using the MeshLab software.

Finally, the following 3D models were generated (Fig.8– Fig.10):

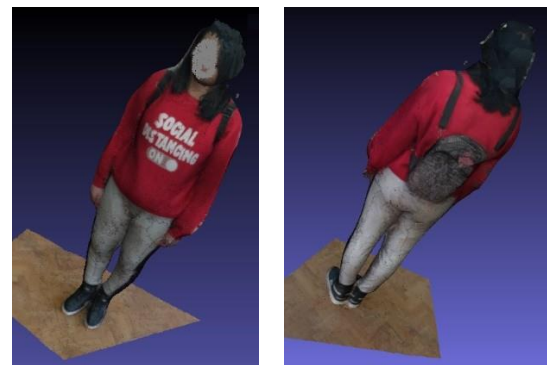

Figure 8. Female\_1 3D model

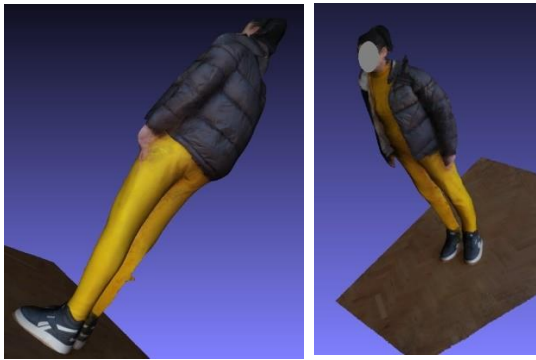

Figure 9. Female\_3 3D model

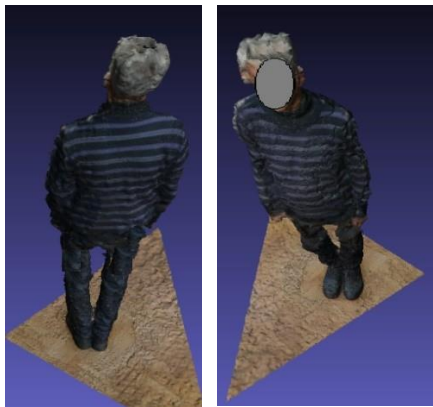

Figure 10. Female\_7 3D model

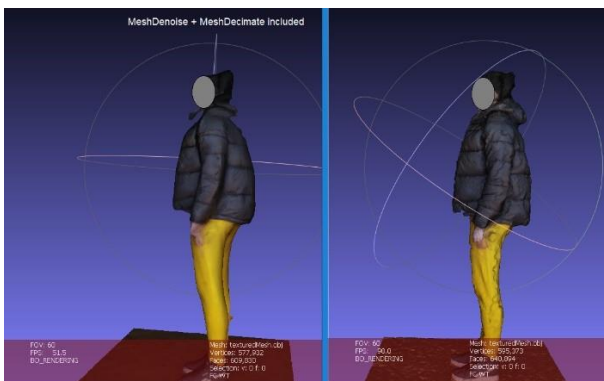

Figure 11. Comparison of using vs. not using MeshDenoise and MeshDecimate

## V. DISCUSSION AND CONCLUSIONS

Digital photogrammetry has become very popular and it is broadly used in variety of fields, like: topographic mapping, architecture, engineering, manufacturing, cultural heritage, medicine, education etc. It requires a series of overlapping photographs, taken of the physical object, from which a 3D reconstruction is obtained using photogrammetry software. Many factors influence the creation of accurate 3D models, such as camera positions, lighting conditions, object reflection, coverage of the scanned physical object, percentage of photos overlapping etc.

In this paper we have presented the creation of the 3D model of the human body. Regarding data

acquisition, multiple scenarios were conducted in slightly different conditions in order to draw certain conclusions. Lessons learned during this study are:

- Pictures must be taken from different angles around the object;
- Flashlight should not be used;
- Pictures should be taken in indirect light;
- Consistent ambient light is required, thus the indoor shooting is better than the outdoor;
- It is always better to take more pictures;
- Focal length should be fixed during the photoshoot;
- Overlapping should be within range 60% - 80%;
- The background of the image has a direct impact on the quality of the final model; thus, it should be fixed (non-movable);
- Plain background is recommended;
- Shadows should be avoided;
- Plain and one-colored surfaces should be avoided;
- The human body should fill most of the frame;
- The object should not wear clothes that create reflection;
- Visual color contrast between the background and the object is required.

For 3D reconstruction of the body, the Meshroom software was used. Meshroom contains various functions, as well as wide range of possible nodes that can be included in the reconstruction processes, with a lot of combinations, in order to generate more realistic 3D model. However, for more accurate output, intervention in the source code (Meshroom is a Python application that relies on the AliceVision framework) would be necessary and will be considered for further research.

## REFERENCES

- [1] Duh, E.S., Koceska, N. & Koceski, S. Game-based learning: educational game Azbuka to help young children learn writing Cyrillic letters. *Multimed Tools Appl* 76, 14091–14105 (2017). <https://doi.org/10.1007/s11042-016-3829-9>
- [2] Davcev, K., Koceska, N., & Koceski, S. (2019). Teaching Basics of Serial Robot Chains's Kinematics to Computer Science Students. In: *International Conference on Information Technology and Development of Education – ITRO, Zrenjanin, Serbia.*
- [3] Runcev, K., Koceska, N., & Atanasova-Pacemska, T. (2017). Tangible user interface for pre-school children learning. In: *International Conference on Information Technology and Development of Education – ITRO, Zrenjanin, Serbia.*



- [4] Hashim, M. H. M. (2015). Using technology and instructional e-material among technical teacher and student into teaching and learning: A qualitative case study. *International Education Studies*, 8(3), 175.
- [5] Gogova, M., & Koceska, N. (2014). The use of QR codes in education. *A journal for information technology, education development and teaching methods of technical and natural sciences*, 4(1), 21-24.
- [6] Velinov, A., Koceski, S., & Koceska, N. (2021). A review of the usage of telepresence robots in education. *Balkan Journal of Applied Mathematics and Informatics*, 4(1), 27-40.
- [7] Timovski, R., Koceska, N., & Koceski, S. (2020). The use of Augmented and Virtual Reality in Education. In: *International Conference on Information Technology and Development of Education – ITRO, Zrenjanin, Serbia*
- [8] M. Sirakaya and D. A. Sirakaya (2018). Trends in educational AR studies: a systematic review. *Malaysian Online Journal of Educational Technology*, vol. 6, no. 2, pp. 60–74.
- [9] M. Akçayır and G. Akçayır (2017). Advantages and challenges associated with AR for education: a systematic review of the literature. *Educational Research Review*, vol. 20, pp. 1–11.
- [10] Meshroom – 3D Reconstruction Software. Available at: <https://alicevision.org/#meshroom>
- [11] MeshLab – open source system for processing and editing 3D triangular meshes. Available at: <https://www.meshlab.net/>
- [12] Aber, J. S., Marzloff, I., & Ries, J. (2010). Small-format aerial photography: Principles, techniques and geoscience applications, Chapter 3 – Photogrammetry. Elsevier, 2010, Pages 23-39.
- [13] Awange J., Kiema J. (2019) Fundamentals of Photogrammetry. In: *Environmental Geoinformatics*. Environmental Science and Engineering. Springer, Cham.
- [14] Kaneko, H. Estimating breathing movements of the chest and abdominal wall using a simple, newly developed breathing movement-measuring device. *Respir. Care* 2014, 59, 1133–1139.

# The Application of Scrum in Companies: A Systematic Literature Review

M. Gaborov\*, S. Popov\*\*, D. Karuovi \*, D. Radosav, D. Milosavljev\*, E. Terek-Stojanovi \*

\*University of Novi Sad, Technical faculty “Mihajlo Pupin” Zrenjanin, Serbia

\*\*University of Novi Sad, Faculty of Technical Sciences, Novi Sad, Serbia

majagaborov26@gmail.com, srdjanpopov@uns.ac.rs, dijanakaruovic@gmail.com, milosavljevd@yahoo.com, terekedita@gmail.com

**Abstract** - Agile software development has become a popular way of developing software. A scrum is widely used since 1990s in software development industry which is a fast changing and demanding industry so companies need to hire qualified employees who can manage themselves in a team based organizational structure to meet and exceed customer expectations. Scrum is the most frequently used agile framework, but it is often reported to be adapted in practice. The aim of this paper is to show how SCRUM methodologies from different research in different environments are applied and how much the methodology is represented. The results show that the scrum methodology is applied to a large extent only in different ways depending on the needs of companies.

## I INTRODUCTION

Software development companies use different agile methodologies to control and assess the projects performance. Depending on how big an enterprise is, some methodologies are more recommended than others. But there is a predominant methodology SCRUM [1][2]. Agile software development has become a popular way of developing software [3][4][5][6][7].

Scrum is the most frequently used agile framework [3][8][9][10][11]. Scrum is an iterative design method [3][9]. “SCRUM is a simple process for managing complex projects” [12]. The word Scrum originates from rugby, and refers to the situation where the team is gathered to plan the following part of the game. This also describes the essence of Scrum where the team gathers each day and informs the others of their current work situation. This meeting should last no more than 15 minutes and be conducted with all team members standing up [8]. This paper shows how the mentioned methodology is applied in different companies, people apply the methodology in a variety of ways.

## II THEORETICAL CONSIDERATION

Communications management is a core concept in agile because it is required to communicate with the customer and with the project team throughout the project in order to achieve the best product,

therefore to achieve project success [13]. Agile methodologies are a group of incremental and iterative methods that are more effective, and have been used in project management [14]. Scrum is the most frequently used agile process framework with more than 70% of the answering companies using it [3]. The roles involved in Scrum are: Scrum Master, Product Owner and Development Team [3][8][4][14].

The Scrum Master is responsible for the team sticking to the rules of Scrum and for organizing the events. It is his or her task to introduce changes to optimize the productivity of the Development Team [3][15]. The scrum master is a servant-leader of the scrum team. The scrum master helps outsiders to distinguish helpful interactions with the scrum team [6]. The scrum master responsibilities are as follows:

- x Being a facilitator
- x Being knowledgeable about the scrum process
- x Coaching the team and the product owner to enhance the team performance
- x Removing impediments
- x Protecting the team from interruptions
- x Holding scrum practices and values
- x Making the work visible [6]

The Product Owner is the interface between the Development Team and the stakeholders of the project. It is his or her task to collect all requirements and add them to the Product Backlog, the list of known requirements and related tasks.[3][15][7] The Product Owner has to prioritize the requirements in the Product Backlog. She or he is the only one authorized to change the Product Backlog, and “the Product Owner is one person, not a committee”. Product owner should have the following characteristics:

- x Having a compelling and an executable product vision which generates a high income and initiates passion.
- x In the team, the organization and customers.
- x Building a roadmap for executing the vision which people can see and sign up for.
- x Building an adequate and a timely product backlog.
- x Spend half of his/her time with marketing, sales and customers.
- x Spend other half of his/her time working with the team to clarify specifications [6].

The Development Team contains of three to nine developers who are self-organizing and cross-functional [3][15][7]. The development team has members who deliver a releasable increment of “done” product at the end of a sprint [6]. The development team has the following characteristics:

- It is self-organizing. No one can tell the development team how to turn the product backlog into increments of a releasable functionality.
- It is cross-functional with skills to create a product increment.
- A scrum does not recognize titles for team members whatever the work they perform.
- A scrum does not form any sub-teams whatever the domain is addressed.
- Members of the development team can have specialized skills and focus areas, but the development team is accountable.
- Optimal development team size is large enough to complete the work within a sprint and small enough to remain nimble [6].

The product is developed in iterations called Sprints taking two to four weeks with a fixed length (that could vary over the teams). A Sprint can only be abandoned by the Product Owner if the aim of the Sprint does not match the aim of the project anymore. At the end of each Sprint, a releasable working (software) product is available [3][15][16][7]. The Sprint Planning defines the aim of the Sprint: The Product Owner presents the backlog items with the highest priority, and the Team estimates how many of them can be accomplished in the next Sprint. This results in the Sprint Backlog containing all requirements the team committed to accomplish. During the Sprint, the Development Team holds a Daily Scrum of 15 minutes maximum supervised by the Scrum Master. In this event three questions are answered: What

have I accomplished yesterday to fulfil the Sprint aim? What will I do today to approach the Sprint aim? Did I encounter a problem which could interfere with the progress? In the Sprint Review, at the end of each Sprint, the Sprint results are presented to the stakeholders and accepted based on a common definition of “Done”[3][17][7]. The stakeholders give feedback about the new increment and further progress is discussed. In the Sprint Retrospective, the Development Team reflects about the Sprint to detect problems and develop solutions [3][7]. Figure 1 shows described SCRUM process.

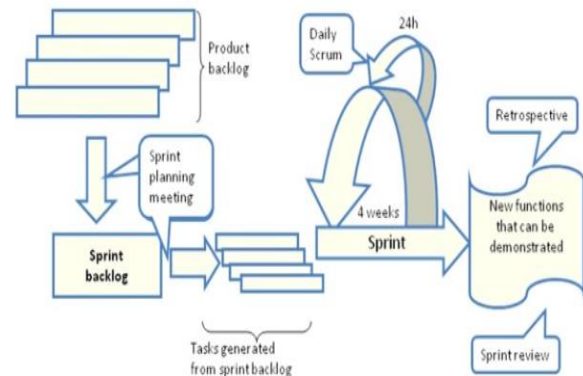

Figure 1. Scrum process [9]

#### A. Sprint planning-requirements clarifications

Sprint planning is performed in a meeting where take part all team, including all roles on the project (developers, testers, analysts, Product Owner). During the meeting, it is settled the sprint duration, decision that is taken by the team [4][7].

#### B. Estimation of tasks from sprint

Represents the planning of the sprint in detail. For this, first is defined what features should be implemented, then is taken the list of sprint and divided into smaller tasks for being estimated. As result of the estimates, it is defined the Scope of The Sprint which represents the tasks that can be implemented in the allocated time for sprint. The tasks that cannot be covered during the current sprint are passed in the backlog for being scheduled for next sprints, or can be kept for being implemented in case the team finish faster, the list of tasks from the sprint [4].

#### C. Create a panel to make visible the status of the sprint

The panel contains mainly, the tasks that are arranged according with their status. That panel allows a better visibility of the sprint for entire team and it is the center of all discussions related with the project, the place where takes place the daily stand-ups, the place where can be found information regarding the project. Usually, the panel is represented by a whiteboard where the team sticks post-its with certain information [4].

#### D. Implement the sprint

In this phase, the team has to implement the assumed tasks in the preceding steps. For this, the team must be empowered with the responsibility of implementing the sprint. Thus, it is very important that no one to make decisions over the development team, otherwise it is possible the team to lose interest in obtaining the objectives of the sprint. In the meantime, the Scrum Master must show support for the team, to guide and assist the team, when the team asks all these. In case, it is noticed that some features are not possible to be implemented during the sprint, they can be moved in backlog for being prioritize for next sprints, but in case the team finishes the sprint faster, it is possible to include other tasks in the sprint [4].

Figure 2 shows Agile Project Management. Scrum is an iterative and incremental project management approach that provides a simple “inspect and adapt” framework. In Scrum, software is delivered in increments called “Sprints” (usually 2-4 weeks iterations) [6].

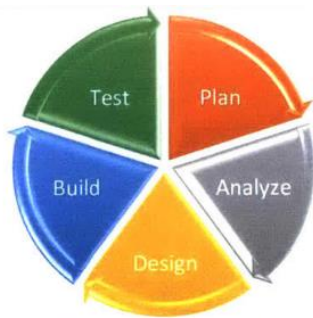

Figure 2. Agile Project Management – Iterative [18]

Agile is a general concept used for different methods for software project management and -development. Agile can be thought of as a link between software development and business management. Examples of methods that fall under agile are eXtreme Programming (XP), Scrum, Crystal Clear, Feature Driven Development (FDD), Lean Software Development, Dynamic System Development Methodology (DSDM) and Kanban [19]. Some research shows that organizations that use agile most often apply Scrum, or in 52% of cases [19].

As many as 54% of companies studied use Scrum. Scrum with XP (32%) was the second most popular choice to be soon followed by XP (11%) and Kanban (9%). The methods that were used the least are TDD (2.5%), Crystal (2.5%), DSDM (2%) and FDD (2%). Summing up the percentages of the Agile methods used results in 114%. This implies that some organizations followed more than one Agile method. A summary of the Agile methods used is shown in Figure 3[4].

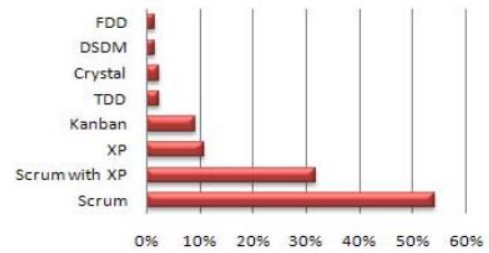

Figure 3. Agile methods used

Figure 3. Agile methods used [4]

### III DISCUSSION

Using structured interview guidelines, the authors interviewed ten German companies about their specific use of Scrum and analyzed the results. All companies vary Scrum in some way. The least variation is in sprint length, events, team size and requirements engineering. Many users have changed roles, effort assessments and quality assurance. Many variations represent a significant deviation from Scrum as originally proposed. There are good reasons for some of these variations. However, sometimes the variations are the result of a previous non-agile, hierarchical organization [3]. The team is the central part of Scrum and an important limitation is the size of the team. Several companies extend the team size below and above the recommended 3-9 people. Two companies have teams with only two members. Three companies work with teams of up to ten members, where one of them even has more than 10 members. The reason is that there was originally a classic team of 25 people [3]. Half of the companies follow the standard idea of a Product Owner in their projects. Often, the Product Owner is a business analyst responsible for one or more teams (to reduce effort for communication between them). One company also had a hierarchy of Product Owners. Two companies even had a Product Owner directly from the customer. In one company, the Product Owner was both, the business expert and the project manager. In one company, there were two Product Owners: one being the internal software architect and one being the external customer. Others reported that they either do not have a dedicated Product Owner at all and receive requirements directly from stakeholders or have a separate product management (department). Finally, in one company, a developer took this role because of the company size of four people. Almost all interviewees stated that they use the role of the Scrum Master in some way. However, the implementation differs. Companies fill this role with an existing project manager or team lead, split it between project manager and software architect or have one of the developers as Scrum Master. Thus, the main difficulty seems to be that being Scrum Master for only one team is not a full-time job. Two

companies report that having one of the developers as Scrum Master works well with a strong-minded and experienced developer, because such a person has a better insight into the technicalities of the project [3]. In another company, where the Scrum Master is mainly a developer, the role degenerated to an event organizer. Only one company does not name a Scrum Master explicitly. In all companies without a dedicated Scrum Master, the costs seem to play a major role. The role is shifted in the direction of a project manager, because the team members are working on many different projects simultaneously, and so the Scrum Master is also in charge of managing the progress of different projects [3]. All interviewees reported that their companies run fixed-length Sprints. The length of these Sprints is mostly four weeks but some also used two or three weeks. The smallest company uses a fixed Sprint length in a project but varies over projects. They sometimes even run one-week Sprints. One company reported that they separate “normal” Sprints of four weeks from subsequent two-week Sprints for clean-up work. One company handles new product generations more flexibly but has fixed-length Sprints for established products. One interviewee reported that the Sprint is not shielded from outside changes to let the product management remove stories from or push stories into ongoing Sprints. Although the Daily Scrum is a central means of communication in Scrum, we found that most of the companies do not follow. Some companies hold events of 30 minutes instead the 15 minutes. There are also results that the event is done every other day or only once a week, if there are not enough news. One company allows members and Scrum Masters of other teams, who are responsible for interfaces, to be present at the Daily Scrum. This should make agreements on these interfaces easier. Furthermore, several interviewees reported that discussions are allowed during their Daily Scrums. The reason is that then they discuss issues relevant for everyone on the team and decisions can be made. One interviewee described that they hold the event structured according to the currently relevant User Stories and discuss them one by one because of higher efficiency [3].

In a study examining the use and perception of agile software development in industry, respondents were distributed in different geographical locations in North America, Asia and Europe. Of all respondents, 72.6% were individual associates, 16.5% were managers, and 7.2% were managers of managers. From the adoption point of view, 156 out of 487 people said that their team used ASD. 125 out of 192 answers to this question showed that they use Scrum ASD methodology. Respondents who responded to others (22) were asked to list the ASD

process they used. Most mention a variant of Scrum or a practice that is freely based on Scrum [20]. Among people currently using 89.7% prefer or are neutral to ASD. More importantly, among groups not using ASD, 92.8% said they liked or were neutral about ASD, indicating that the vast majority of developers are open to trying ASD in the future. About 60% of respondents agree that ASD works well for them and their team. However, less than 40% agree that ASD works well for a wider group. Less than 20% of respondents say that their team morale has decreased due to ASD, and only 10% note that ASD has affected (negatively) communication between development and test teams [20].

The results from one study show that Scrum has great potential in the design and planning departments of construction firms. From the analysis of the applications of Scrum in the case study, tangible benefits and weaknesses of the implementation, and its different artifacts, were identified [21].

In some research the results show that most research participants use different project management methods. They apply the methods that best suit their own operations. The understanding of the role and responsibilities of product owners is quite different among organizations, but rarely in perfect agreement with the official Scrum method. Cases have been reported in which there are two product owners for the same product. One is then responsible for the business aspect, but the other is responsible for the technical aspects of the product. Scrum has a strong position in software development with its defined roles, emphasis on collaboration, understanding, visibility, efficient process and rapid development [19].

#### IV CONCLUSION

The way Scrum is applied in reality is very different between organizations and even within departments of the same organization, between projects and different Scrum teams. Companies differentiate Scrum in some way. The smallest variations are in sprint length, events, team size and requirements engineering. Many variations represent a significant deviation from Scrum. The team is the central part of Scrum, and an important limitation is the size of the team. The role of Scrum master is used. However, the implementation differs. In all companies without a dedicated Scrum Master, costs seem to play an important role. The duration of sprints is usually four weeks, but somewhere between two or three weeks. Although Daily Scrum is the central means of communication at Scrum, not everyone practices it. Mentioned methodology is applied more than other agile methodologies, it is

applied differently in different companies. In the future, it could be investigated how scrum is applied in IT companies in Serbia.

### REFERENCES

- [1] G. Casademunt Triay, "Identification of the training necessities for the further training plan development regarding to the SCRUM knowledge in the company Da Codes", Master's thesis, Universitat Politècnica de Catalunya, 2020.
- [2] K. D. Praetya, Shuarjito and D. Pratama, "Effectiveness Analysis of Distributed Scrum Model Compared to Waterfall approach in Third-Party Application Development", *Procedia Computer Science*, vol. 179, pp. 103-111, 2021.
- [3] P. Diebold, J-P. Ostberg, S. Wagner and U. Zandler, "What Do Practitioners Vary in Using Scrum?", In *International Conference on Agile Software Development*, Springer, Cham, pp. 40-51, May 2015.
- [4] B. Ciurairu and C. Risu, "Usage of Scrum Methodology for Implementing Software Project", In *Managing Innovation and Diversity in Knowledge Society Through Turbulent Time: Proceedings of the MakeLearn and TIIM Joint International Conference 2016*, ToKnowPress, pp. 713-721, 2016.
- [5] P. Ozoli š, "Preparation and Facilitation of Retrospective Meeting in Scrum Process", In *Information Technology and Management Science*, pp. 60-63, 2018.
- [6] Hossain, M. A. Babar and H. Paik, "Using Scrum in Global Software Development: A Systematic Literature Review", In *2009 Fourth IEEE International Conference on Global Software Engineering*, pp. 175-184, 2009.
- [7] L. Gonçalves, "Scrum", In *Controlling & Management Review*, vol. 62, pp. 40-42, 2018.
- [8] L. S. Møller, F. B. Nyboe, T. B. Jørgensen and J. J. Broe, "A Scrum tool for improving Project Management", In *Proceedings of fifth Student Interaction Design Research Conference*, pp. 30-32, April, 2009.
- [9] V-P. Eloranta, K. Koskimies and T. Mikkonen, "Exploring ScrumBut—An empirical study of Scrum anti-patterns", In *Information and Software Technology*, vol. 74, pp. 194-203, 2016.
- [10] T. Gustavsson, "Benefits of Agile Project Management in a Non-Software Development Context: A Literature Review", In *Project Management Development – Practice and Perspectives: Fifth International Scientific Conference on Project Management in the Baltic Countries*, pp. 114-124, 2016.
- [11] Z. Ereiz, and D. Muši , "Scrum Without a Scrum Master", In *2019 IEEE International Conference on Computer Science and Educational Informatization (CSEI)*, pp. 325-328, 2019.
- [12] S.S. Tirumala, S. Ali, A. G. Babu, "Hybrid Agile model using SCRUM and Feature Driven Development", In *International Journal of Computer Applications*, vol. 156, no. 5, 1-5, 2016.
- [13] V. Holzmann and I. Panizel, "Communications Management in Scrum Projects", In *International Conference on Information Management and Evaluation*, pp. 67-54, Septembar 2013.
- [14] H. Lei, F. Ganjeizadeh, P. K. Jayachandran and P. Ozcan, "A statistical analysis of the effects of Scrum and Kanban on software development projects", In *Robotics and Computer-Integrated Manufacturing*, vol. 43, pp. 59-67, February 2017.
- [15] A. T. Karabulut and E. Ergun, "A new way of management: A scrum management", In *International Journal of Commerce and Finance*, vol. 4. iss. 2, pp. 108-117, 2018.
- [16] J. Noll, M. A. Razzak, J. M. Bass and S. Beecham, "A Study of the Scrum Master's Role", In *International Conference on Product-Focused Software Process Improvement*, Springer, Cham, pp. 307-323, November, 2017.
- [17] A. Välimäki and J. Käriäinen, "Patterns for Distributed Scrum — A Case Study", In *Enterprise Interoperability III*, pp. 85-97, 2008.
- [18] A. K. Tomar, "Study of Scrum Framework Usage in Non-Software Systems", (Doctoral dissertation, Massachusetts Institute of Technology), 2017.
- [19] H. S. Sverrisdottir, H. T. Ingason and H. I. Jonasson, "The Role of the Product Owner in Scrum-comparison between Theory and Practices", In *Procedia - Social and Behavioral Sciences*, vol. 119, pp. 257-267, March 2014.
- [20] A. Begel and N. Nagappan, "Usage and Perceptions of Agile Software Development in an Industrial Context: An Exploratory Study", In *First International Symposium on Empirical Software Engineering and Measurement (ESEM 2007)*, pp. 255-264, 2007.
- [21] T. Streule, N. Miserini, O. Bartłomé, M. Klippelc and B. Garcíade Soto, "Implementation of Scrum in the Construction Industry", In *Procedia Engineering*, vol. 164, pp. 269-276, 2016.

# Digital Marketing of Agricultural Holding in Republic of Serbia

M. Knežević\*, N. Bobinac\*

\* Technical Faculty 'Mihajlo Pupin' Zrenjanin, Serbia  
littlepanda.mk@gmail.com, nikolabobinac@gmail.com

**Abstract** – This paper shows the process and procedure of making a quality digital marketing plan for an agricultural holding in Republic of Serbia. Situational analysis, goals, budget and other characteristics are based on the agricultural holding "Vineyard Knezevic" from Melenci. The goal of this paper is to with proper and efficient digital marketing increase the income of the agricultural holding and for it to acquire and adequate position on the market. Basing on analyzing the target group, the team gets appropriate results and solutions on how to achieve the goal.

## I. INTRODUCTION

The Knežević family from Melenaca produces table varieties of grapes in the Republic of Serbia on 2.5 hectares of land. Since 1995 they based their production on the Muskat Hamburg variety. Customers have available three classes of products. The first class encompasses grapes without any type of damage. It has an average sugar content of at least 19%. The second class are grapes with minor physical damage. On average they have 17% sugar content. The third class are grapes with and without physical damage with sugar content between 12% and 15%. [2]

Every client that is interested in buying any of the three classes which the agricultural holding offers has the options: choice, reservation and additional benefits. Interested clients can decide the class on their own, reserve an order and decide a precise date when to pick up the product. The client can also chose whether or not to pick up the product already processed or not.

Current geographical market is the autonomous province of Vojvodina, in the biggest percent the Banat region with 67%. The province has 2031992 citizens, of which the region of Banat has 668397. [4] Estimated population of the total targeted area is 450700 people. [3] Demographical target group are people mostly male, regardless of marital status or educational degree between 25 and 70 years old with an average income of 540000 RSD. From psychological analysis the target client is a social person, who considers themselves as a person

with reputation in society and is proud with its further products and wants to show others their skills, visits vine fairs, vineyards, has interests in tourism and agriculture.

Republic of Serbia offers certain benefits to people under 30, in the development of their production they get a 50% return for invested funds, but also for women who want to start some sort of production they offer loans with 1% interest rate. It is expected that processing of grapes starts abruptly increasing on the market from the side of younger people. For older people processing of grapes represent mostly a hobby which they take when they stop working full time and because of that a lot of them are preparing installations for processing and maintaining products, which later on younger generations can continue to work on and develop them to a professional level.

Based on research, from year to year the population of autonomous province of Vojvodina is in a decline, which can bring a fall in production. From a census in 2011 there were 1931809 citizens in Vojvodina, 26.88% of the total population of Republic of Serbia. From that number the demographic of males between 25 and 30 years old is 591288 people. Based on official statistics a decline in population is expected. The country is helping by providing certain benefits to everyone who wants to start their production. That way the people that stay in the country can maintain the quality and tradition. From the words of professor doctor Ninoslav Nikičević from the Agricultural faculty, University in Belgrade, we can protect our production of fruits, primarily fruit distillates, from which the world will recognize us. Since professor doctor Ninoslav Nikičević is one of the members in the International Fair of Novi Sad it can be claimed with certainty that people who take up production of products, in this case distillates of fruits, from hobby have high quality and recognizable aroma and with that they gain a high price. [2] It is expected that in one moment the processing of fruits will be higher

than projected, even with the decline in population. Republic of Serbia has already made deals with other countries for export of fruits and fruit products.

Applying SWOT analysis resource capabilities and weaknesses can be estimated, market opportunities and other dangers which can effect further development of enterprises in this sector. The power of this agricultural holding is based on its use of own original methods of preservation and improvement, nurturing and production of table varieties of grapes. The opportunity of this agricultural holding is that if they promote on social mediam with a certain marketing plot and engage more in fairs and festivals, they could increase their sales. In that way at the end of the season the excess of grapes would be minimal. The only weak spot in this agricultural holding are climate conditions which can effect the amount of yield of grapes. A threat to the agricultural holding can be an economical crisis which can affect they financial resources of buyers.[1]

## II. PREVIOUS WORK

The target group are males between 25 and 70 years old, which deal with further processing of grapes making products like: wine, rakija or juice. Men which do this job mostly do it out of hobby so they could gather people around them. The buyers are in great number professors or people who work in a prospective field and in this way they want to prove themselves to others and point out their abilities to do something else. In a very low percent the buyers of product are women, but they usually have consultants in the mentioned target group.

The agricultural holding Vineyard Knežević form their prices based on theoretical knowledge. To get one liter of distillates about 10kg of grapes are needed, from that 5% needs added sugar diluted in water. A liter of distillates of grape has a minimal prica of 600 RSD in stores. A kilogram of Muskat Hamburg at the start of September is between 120 and 200 RSD. So the price is gathered by taking the minimal store price and halving it. Since the sales are oriented on large volume orders, not market sales, this price can be used. Also, the price is formed based on the minimal price of distillates divided by 10. Which bring the final price to 60 RSD/kg.

Factors which can affect the change of grape prices are:

- Pandemics – can lower the price

- Lowering of salaries and pensions – when this happens people will prioritize buying basic needs.

- Lower yield of vineyard– Can cause a rise in prices because of lower demand. This only occurs if the total yield is below 20000kg. If in that situation the price stays the same it is considered that the agricultural holding is selling at a lost.[5]

Loyal customers get certain benefits. A customer becomes loyal when they have bough grapes from the same supplier for years in big quantities. Then individually in agreement with the customer a deal is made for a discount if needed or payment in installments. The situation starts if the customer says they have financial issues and the agricultural holding tries to help them out in that way.

## III SOFTWARE APPLICATION DEVELOPMENT

With the goal of growth and development of production promotions are planned throughout the year.

Since the production is of a seasonal character it is needed to maintain continual promotions throughout the year. In that way new customers can be found in the following ways.

- On the already existing Facebook page „Vinogradi Knežević” and Instagram account @vinogradiknezevic regular posts have to be made with current vineyard pictures and short stories to follow them.

- Short stories must enchanche to every viewer how the production functions. The stories need to have a theme of: family, motivating women in agriculture, family gathering, motivating youth, working together, and so on. The stories need to relate to the feelingof pleasentness and motivation.

- Public advertising on TV media channels Santos, RTS and RTV.

- There are also plans for showing off products on festivals, international fairs and other manifestations of a competitive nature.

- When harvest starts the advertisements should also have the phone numbers in local advertisement media and social media.

The diagram shows the promotion activities in the following table:



Table 1. Promotion activities

Meseci	1	2	3	4	5	6	7	8	9	10	11	12
Aktivnosti												
Facebook	X	X	X	X	X	X	X	X	X	X	X	X
Instagram	X	X	X	X	X	X	X	X	X	X	X	X
TV mediji					X	X	X					
Učešće na festivalima		X	X		X	X	X					
Oglasi							X	X	X			

To reach a bigger audience of social media users certain promotions need to be payed for. In that way Instagram and Facebook promote the page as an advertisement to other users of the social media.

The following picture contains the Facebook page. Currently the Facebook page has 520 people following it.

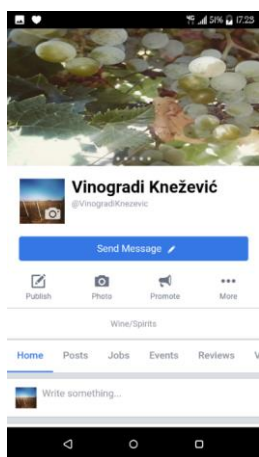

Figure 1. Facebook page

On Instagram there are currently 497 followers.

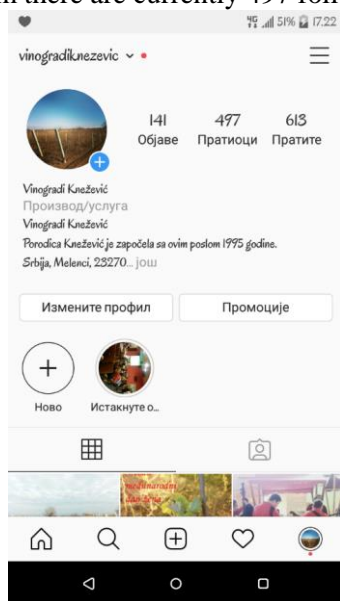

Figure 2. Instagram account

Maintaining contact with customers is mainly done on social media. On social media the followers are notified of the start and end of each phase of production and development.

Updates are based on text and pictures where buyers can see which techniques are used to press the vineyard and which mechanisms are used for production. In that way the customers are kept up to date every month about production and are reminded to make reservations in time.

Every year the harvest starts at a different time. Because of that it is important to continually update customers in which phase the production is.

In that way they can organize themselves on time and prepare their spaces and mechanism for further processing and storage of grapes.

#### IV. CONCLUSION

Vineyard Knežević as an agricultural holding located in the center of Banat believes da production in Republic of Serbia has a great path ahead of itself for further development. With continual development, support and advice from professors from Agricultural faculty the holding thinks they can achieve more in the future and motivate young people to stay in the country and start their own production.

This agricultural holding tries to perfect its techniques from year to year and with taht include modern mechanisation which will play a key factor the the brands reputation. Currently there is no competition but the holding hopes to motivate young people. Competition in the market represents a challenge for further development.

Production of grapes does not represent a burden. Family support is key, they are the ones that give the motivation needed for further development and growth. After the vineyard grows past a certain point it opens up an opportunity for tourism, which would because of the location help with the development of tourism for the whole village.

There are many oportuinites and all can be developed if this family tradition continues.

#### REFERENCES

- [1] D.Đorđević, D.Čočkalo, Osnove marketinga, Drugo izdanje, Univerzitet u Novom Sadu, Tehnički fakultet „Mihajlo Pupin” Zrenjanin, 2010 godina.
- [2] N.Nikičević, R.Paunović, Tehnologija jakih alkoholnih pića, Prvo izdanje, Dobra knjiga, 2013 godina.
- [3] [https://brzipopis.rs/?gclid=CjwKCAjwsMzzBRACEiwAx4iLg80nuFKCzTeFLR4XizlHioL6U75KVeP4ns8mKIEhkD3we65WK4a-dhoC4GkQAvD\\_BwE](https://brzipopis.rs/?gclid=CjwKCAjwsMzzBRACEiwAx4iLg80nuFKCzTeFLR4XizlHioL6U75KVeP4ns8mKIEhkD3we65WK4a-dhoC4GkQAvD_BwE)
- [4] [https://bs.wikipedia.org/wiki/Popis\\_stanovni%25%A1tva\\_u\\_Srbiji\\_2011\\_\(Vojvodina\)](https://bs.wikipedia.org/wiki/Popis_stanovni%25%A1tva_u_Srbiji_2011_(Vojvodina))
- [5] <http://polj.uns.ac.rs/sites/default/files/udzbenici/VO%25%20VINOGRA%20DARSTVO%20DEO%20VINOGRA%20KONACNA%20VERZIJA.pdf>

# Testing Using Selenium

M. Knežević\*, N. Bobinac\*

\* Technical Faculty 'Mihajlo Pupin' Zrenjanin, Serbia  
littlepanda.mk@gmail.com, nikolabobinac@gmail.com

**Abstract** – This paper shows basic characteristics and notes about testing software, as well as the role of software tester development in a complex and quality team. This work displays basic concepts as well as the importance of software testing efficiency at certain stages. Based on facts, this work attaches an example of testing using selenium testing tools. In this paper is tested one Login website form by Selenium tool. In addition to the use of the tool, they are described more important characteristics. For today, the importance of testing comes to a more prominent expression and a more appreciated position in one developed team.

## I. INTRODUCTION

Testing is the process of analyzing software items in order to detect differences between existing and required conditions and evaluating software features. Tester is a member of the team that must be placed in the role of the client itself or the targeted group of users, but also to be placed in the role of developer who creates a software application.

The role of the tester also has significant responsibility for the company for which they work, some mistakes that are not seen at first sight can lead to greater financial losses later. In the lifecycle of software development, testing begins with the demand collection phase and may take until the use of the software itself. Testing in any of the stages of the software's development cycle is conducted in a specific way, for example during the collection phase, analyses and verification of testing requirements are considered. Design review at the design stage aims to improve the design. The tester then sets himself up as an ordinary user and pays attention to whether the colors are adequately incorporated, what it is that holds attention, whether the design remains remembered... The tester can never say that some software is 100% tested, no software can be tested to the tiniest atom. It is essential to take into account the following aspects, which would mark the end of the testing process:

- Testing deadlines should be set,
- Completing the execution of the case test

- Completing functional and code coverage up to a certain point,
- Error rate falls below certain level and no high priority errors identified,
- Management or parent decision.[1]

Testing is different from the debugging process. Testing involves identifying an error, malfunction, or dysfunction in the software without correcting it. While the debugging process involves identifying, isolating, and troubleshooting or errors.

In the process of testing, it is essential to distinguish the types of errors that exist: error, bug, defects, failure. Error represents an error made by the developer. The bug is the result of an error or malfunction in the program. Defects represent a derogation from the request. Failure represents a deviation of the software from its predicted intent.

Organizations around the world are developing and implementing different standards for software quality improvements. Standard ISO/IEC 9126 deals with aspects that determine the quality of the software application:

- Quality model,
- External metrics,
- Internal metrics,
- Quality indicator in use.

This standard represents a certain set of quality attributes for any software that is implied: functionality, reliability, usability, efficiency, maintenance and portability. These qualities are further divided into certain subfactors.

The ISO/IEC 9241-11 standard proposed a framework that describes the component's usability in the relationship between them. According to this standard, usability depends on the context of usage, and the level of usability itself will change as the context changes. Also according to this standard, the usability of the software application itself is based

on the preformation and satisfaction of users of the same.[5]

There are two types of software testing. It's manual testing and automatic.

Manuel testing is such a method of testing where no automated tool or any script is used. In this test mode, the examiner assumes the role of the end user and tests the software until it identifies any unexpected behavior or error. There are different stages of manuel testing (single testing, intergravation testing and acceptable testing). Testers use a testing plan, tests, or scenarios to test the software, ensuring that the testing process is complete. Manuel's testing also includes research testing to aim to investigate software to identify an error in it.

"Test Automation" is a process when a tester writes scripts and uses other software to test software. Automatic testing is used to restart a scenario test that runs manually, quickly, and repeatedly. Automatic testing is also used to test the application from a load point of view, reformants and stress. Increases test coverage, improves accuracy, saves time and money compared to manual testing. The important questions about automatic testing are: what to automate? When to automate? How to automate? [4]

It is not possible to automate everything in the software. You need to automate areas where a user can make a transaction, such as a sign-in form or registration form, or any area (part of the software) where a large amount of users can access the software at the same time. Parts that test GUI items, database links, field validations can also be automated...

Automatic testing should be used when software: large and critical projects, projects that require frequent examination of the same areas, there are variable requirements, access to the load application and preformations in many virtual users, time factor...

There are many tools available that can be used to write scripts for automation. There are also multiple processes used to automate testing. Processes:

- Identify areas within automation software,
- Select the appropriate interrogation automation tool,
- Writing test scripts,
- Developing a test case,

- Executing scripts,
- Reporting results,
- Identify potential errors or performance issues.[2]

Tools used for automatic testing: HP Quick Test Professional, Selenium, SilkTest, TestComplete, Testing Anywhere, WinRunner, LoadRunner, Visual Studio Test Professional, Watir...

## II. PREVIOUS WORK

Selenium is a free automated testing tool used to validate web applications in different browsers and platforms. It can be used for multiple programming languages (Java, C#, Python...) to create Selenium test scripts. Selenium is not just one tool, but a range of software that meets the needs of selenium QA testing organizations (Selenium IDE, Selenium RemoteControl, WebDriver, Selenium Grid).

Selenium was created by Jason Huggins in 2004. When working on a web application that required manual testing, he realized it was becoming more inefficient. He then created a JavaScript program that automatically controlled browser actions (JavaScript TestRunner). When he saw the potential of this idea to help automate other web applications, he facilitated the script created and created Selenium Core. During one problem with the mercury interactive company, Jason came up with the idea for this tool to be called Selenium. Selenium is known to be a known chemical element that acts as an antidote to mercury poisoning.

The entire Selenium software testing package consists of four components:

- Selenium IDE is a Firefox supplement that can only be used to create realistically simple test cases and program packages.
- Selenium RemoteControl is also known as Selenium 1 because it is the first Selenium tool that enabled users to use programming languages in creating complex tests.
- WebDriver is the latest packer that allows test ingredients to communicate directly with your browser.
- Selenium Grid is also a tool used with Selenium RC to perform parallel tests in different browsers and operating systems.
- Selenium RC and WebDriver were merged to form Selenium 2.

Selenium is more favorable than QTP in terms of cost and flexibility. It also allows parallel runs of tests, while QTP only allows sequential runs of tests.

### III SOFTWARE APPLICATION DEVELOPMENT

Login web form for professors of technical faculty, 'Mihajlo Pupin' from Zrenjanin was selected for this work. (Figure 1)

Before you can start creating an automatic test, you need to install the three items that are required on your computer for this test and reconcile their versions. Need to be installed: Javu, Eclipse, and Selenium (Selenium Server, and Selenium WebDriver). If an error occurs while testing Eclipse, we need to check once again to see if the versions are adequate, also let's not forget that chromeDriver needs to be installed (it is possible to install drivers for any web browser, depending on our needs and the width of the testing).

Since we've decided what we want to test, one of the first basic things about learning automatic testing is testing the LogIn page. It is important to remember that some larger firms and companies, for

their own safety, have decided that the "Confirm" or "LogIn" button has a different ClassName or ID every time they open the same page. So they require a different type of automatic testing. On the faculty's website we have static IDs that do not change their values, which may bring to our attention that we need to perfect and ensure stronger security of this LogIn form.

In the Inspect section, we can see all the necessary IDs and Titles that we need in creating our script for automatic testing. More experienced testers would create this test using classes and objects, using inheritance methods, and test other possible characteristics.

In this example, we will be based only on entering data in e-mail fields and the code and functionality of the confirmation button. It's important to know that since we're not professors in this situation, we're not going to use valid data. Anyway, we're only going to be based on the accuracy of reading the data. The expected result after entering our data is to stay on the same Web page while displaying certain messages.

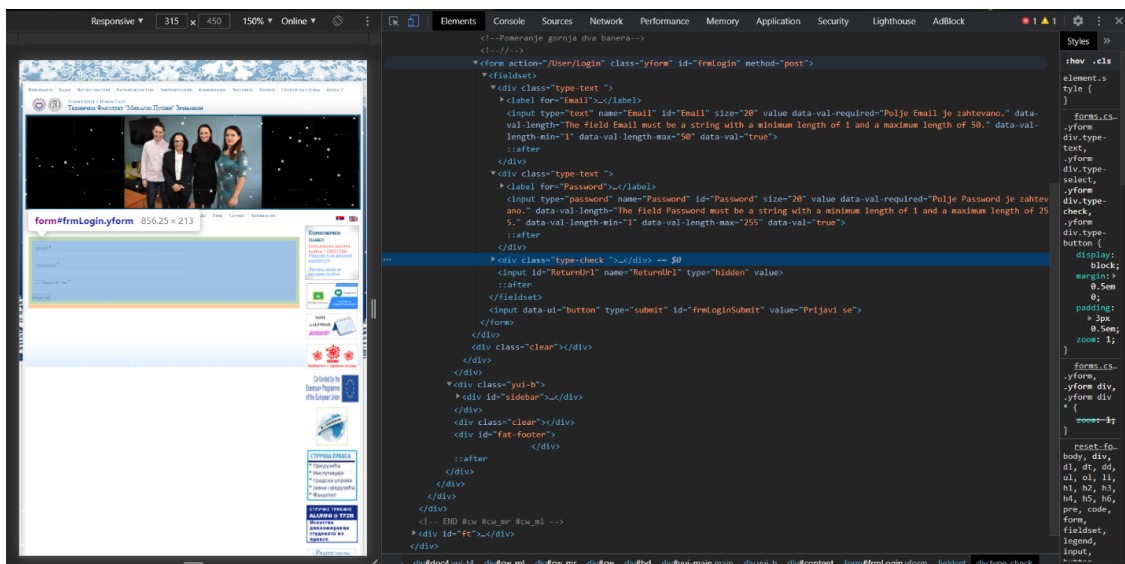

Figure 1- View the page for which an automatic test is created

In a test script, you must first define the package in which our script is used for automatic testing. You then need to add selenium files from selenium that allow us to connect to the Web. Chrome Driver is mostly used for some local connections and its version should match the already installed version of Chrom on our computer. Then we define a class that's type of public. There's a function in that class. Within the feature, the first step to be taken is to

find it in driver. After that step, it is necessary to determine which Web page we want to test. After our Chrome starts the Web page by using the following line of code, it sets it full screen. In two places, thread.sleep (3000) is inserted in the code, which allows us to stop everything on the screen for a moment so that we have a better overview of how automatic testing is conducted. (Figure 2)

```
FirstSeleniumTest.java
1 package mzFirstProject;
2
3 import org.openqa.selenium.By;
4 import org.openqa.selenium.WebDriver;
5 import org.openqa.selenium.chrome.ChromeDriver;
6
7
8 public class FirstSeleniumTest {
9     public static void main(String[] args) throws InterruptedException {
10        System.setProperty("webdriver.chrome.driver", "D:/Driver/chromedriver.exe");
11        WebDriver driver=new ChromeDriver();
12        driver.get("http://www.tfzr.uns.ac.rs/User/Login");
13        driver.manage().window().maximize();
14        Thread.sleep(3000);
15        driver.findElement(By.id("Email")).sendKeys("masa.knezevic@tfzr.rs");
16        driver.findElement(By.id("Password")).sendKeys("Masa1234!");
17        driver.findElement(By.id("frmLoginSubmit")).click();
18        Thread.sleep(3000);
19
20        String at= driver.getTitle();
21        String et="TFZR - Prijava";
22        driver.close();
23        if(at.equalsIgnoreCase(et)) {
24            System.out.println("Test je uspesan");
25        }
26        else
27        {
28            System.out.println("Test je neuspesan");
29        }
30    }
31 }
32
33 }
```

Figure 2- View a created test

Then, we insert elements with a specific ID (We find the value of a field ID in the Inspect options). In these fields, we only set some values that are implied to be entered when applying to a professor. We do not set the sign-in button to enter, but we set that our test should click this using click(). In the last part of the code, string at should take over the title after the action has been completed, and we know that the given page after a certain action should have the value "TFZR – Login", and we assign that value to string et. At that point, the window closes and a message is written in the eclipse window. If the at matches the et will write the message "Test is successful", and if it does not match it will say "The test is unsuccessful".

If some valid data is entered from a particular professor instead of the current data and we do not change the title, we will get it in this case that the test failed because the correct results were not achieved. In fact, the appropriate page did not open. In this test, the goal was to show the initial steps of

testing, this test can be expanded and dispersed in multiple cases

#### IV. CONCLUSION

This work only demonstrated the basis of software testing. It is also the basis for further development and research in the field of testing. It is possible to implement a standalone Web application, which will have an administrator login page. The application will be multi-layered and complex, so it is possible to display multiple tools, principles, and cases of software testing.

#### REFERENCES

- [1] Dorothy Graham, Isabel Evans, Rex Black, Foundations of software testing,
- [2] Mike Andrews, James Whittaker, How to break Web Software,
- [3] Ljubica Kazi, Dragica Radosav: OSNOVE OBJEKTNO-ORJENTISANOG PROGRAMIRANJA SA PRIMERIMA U C#, praktikum za vežbe, Tehnicki fakultet "Mihajlo Pupin", Zrenjanin, 2018,
- [4] Dragica Radosav: Softversko inženjerstvo, Tehnicki fakultet "Mihajlo Pupin", Zrenjanin, 2011.

# The Effects of Locus of Control on Entrepreneurial Behavior

M. Kavalic\*, M. Pečujlija\*\*, Ž. Stojanović\*\*\*, S. Stanisavljev\*\*\*\*, M. Bakator\*\*\*\*\*

\*PhD student, University of Novi Sad, Faculty of Technical Science, Novi Sad, Serbia

\*\* University of Novi Sad, Faculty of Technical Science, Novi Sad, Serbia

\*\*\* PhD student, University of Novi Sad, Technical Faculty “Mihajlo Pupin”, Zrenjanin, Serbia

\*\*\*\* University of Novi Sad, Technical Faculty “Mihajlo Pupin”, Zrenjanin, Serbia

e-mail: mihalj.bakator@uns.ac.rs

**Abstract** - The subject of this paper is to consider the effects of the locus of control as a psychological construct on entrepreneurial behavior. It is assumed that the type of locus of control affects entrepreneurial activities. The sample consisted of engineering students (N=108). The results of the regression analysis showed that the locus of control has an impact on the propensity for entrepreneurship. In more detail, the results showed that the stronger the internal locus of control, the stronger the propensity for entrepreneurship. People with an external locus of control did not show a tendency towards entrepreneurial activities, especially if they had a strong external locus of control.

**Keywords:** locus of control, entrepreneurship, business, Serbia.

## I. INTRODUCTION

Locus of control is often associated with the orientation towards entrepreneurship, both entrepreneurial ideas and the realization of those ideas. Locus of control appears for the first time in social learning theories as a psychological construct [1]. According to Rotter (1966), people who have an internal locus of control are more aware of their possibilities, as well as the possibilities that appear to them in life and at work. Thus, such persons use opportunities to achieve a certain goal and try to improve current conditions. Such persons make an effort to use all opportunities to achieve the goal, they also improve their personal factors in order to be as successful as possible in the realization of their goals. Therefore, they believe that the outcome is solely conditioned by their actions, and not by external factors, so that they feel full responsibility for the realization of the desired goals, unlike people who have an external locus of control [2].

The influence of locus of control on the entrepreneurial spirit appears even at the time of schooling. This is supported by studies, which point out that locus of control has an impact on the entrepreneurial motivation and entrepreneurial

intentions of students [3,4,5]. Vrban, K. (2020), indicates that students with an internal locus of control are very creative, and that these determinants of creativity positively affect their entrepreneurial intentions [6].

Caliendo, Fossen, and Kritikos (2009) say that a trait such as a locus of control is a better predictor when it comes to reacting in a professional field, compared to many other general dimensions of personality. They also point out that the locus of control is a trait that is culturally conditioned [7]. It is interesting to note that the population of countries that have a pronounced individualistic trait, in contrast to countries with a pronounced collectivist culture, have a more pronounced internal locus of control. It can therefore be concluded that countries that have an individualistic culture have a more pronounced entrepreneurial population [8].

## II. RESEARCH SUBJECT, PROBLEM, AND EXPECTED RESULTS

### A. *Subject and problem*

Unemployment and job shortages are a growing problem among the younger population. The inability to find an adequate job and the desire for independence is increasingly present among young people. The subject of this research is the analysis of locus of control as a psychological trait of a person, which points to the predestination to starting one's own business. The paper observes the influence of locus of control type on the propensity towards entrepreneurship.

Based on the subject and research problem, the following research question is proposed:

RQ: Does the type of locus of control affect the propensity for entrepreneurship?

### B. *Aim of the research*

The aim of the research is to show, based on previous research, whether locus of control has an impact on the propensity for entrepreneurship. The aim of the research is also to determine the existence of the influence of locus of control type on entrepreneurial behavior.

### III. THEORETICAL FRAMEWORK

Depending on the type of locus of control, the internal locus of control is stated as a personality trait expressed in entrepreneurs [9,10,11], as well as that persons with an internal locus of control more prone to entrepreneurial actions [10,11,12]. People with an internal locus of control feel more self-efficacy and are therefore more prone to entrepreneurial actions [12]. Many studies confirm that in the entrepreneurial population compared to the general population, the internal locus of control is more pronounced [10,11,13,14,15,16]. Levin & Rubenstein (2017), say that people who start their own business have a distinct internal locus of control, in relation to people who are employed and develop a career working in corporate and non-corporate organizations [16]. This is supported by similar results on the impact of the internal locus of control and entrepreneurial action [13,14,15].

Barrick (2005) argues that specific characteristics such as risk tolerance, achievement focus and needs, are related to locus of control and are important in predicting the success of entrepreneurial actions [17]. According to McClelland (1961), the connection between internal locus of control and entrepreneurial behavior is expected, because it is the initiator of an entrepreneurial venture, ready to take responsibility for his actions and wants to be independent of the environment [18]. Other authors support this, pointing out that it is typical for people with an external locus of control to have constant doubts about their success, and thus doubts about entrepreneurship, that their personal efforts are weak and unwilling to take risks when possible. negative outcome. Therefore, in a person who wants to be a successful entrepreneur, a higher level of internal locus can be established compared to external locus of control [19,20].

An individual recognizes an entrepreneurial opportunity, which he evaluates as feasible and desirable, but he will not take the necessary actions unless he is psychologically predisposed to action [21,22,23]. Internal locus of control is also a predictor of propensity for action, which is key to starting a business [23]. Thus, for example, the

students in whom internal locus of control was observed, were the ones who expressed the desire to start their own business in the future, that is. to engage in entrepreneurship [8].

#### *A. Summary of previous empirical studies on students' locus of control*

The influence of locus of control (as a psychological construct) on the propensity for entrepreneurship is the subject of a large number of previous researches, and the summary of previous studies is presented in Table 1.

Table 1. Summary of previous empirical studies on the effects of locus of control on entrepreneurial behavior

<i>Authors</i>	<i>Effects of locus of control</i>
Sokić, J., & Popov, S. (2019)	Internal locus of control is a personality trait that is expressed in an entrepreneur.
Caliendo, Fossen, & Kritikos, (2009)	Locus of control is a culturally conditioned personality trait, which is a predictor of reaction in the professional field.
Barrick, (2005)	Internal locus of control is related to characteristics such as risk tolerance and the need for achievement, and as such are important in predicting the success of entrepreneurial actions.
McClelland, (1961) Brockhaus, (1982) Brockhaus & Horowitz (1986)	Internal locus of control is related to entrepreneurial behavior, because it is the initiator of an entrepreneurial venture, ready to take responsibility for actions and wants to be independent of the environment.
Mueller & Thomas, (2001)	Countries that have a pronounced individualistic culture, have a more pronounced internal locus of control and have a more pronounced entrepreneurial population.
Caliendo, Fossen, & Kritikos, (2014) Gürol & Atsan, (2006) Hansemark, (2003) Levine & Rubenstein, (2017) Perry, (1990) Shaver & Scott, (1991)	Internal locus of control is more pronounced in the entrepreneurial population than in the general population.

Krueger, (1993)	Internal locus of control is a predictor of propensity for action, which is key to starting a business.
Rizzato, S. de C. e C., & Moran, M. C. (2013)	People with an internal locus of control feel more self-efficacy and are more prone to entrepreneurial actions.
Agyemang, C. B., et al., (2020) Rizzato, S. de C. e C., & Moran, M. C. (2013)	Internal locus of control points to entrepreneurial activities.
Qin, Y., Yan, R., & Sun, Y. (2020) Sun, H., et al., (2020) Agyemang, C. B., et al., (2020)	Internal locus of control indicates the entrepreneurial motivation and intention of the student.
Vrban, K. (2020)	Internal locus of control points to creativity that influences entrepreneurial intentions.
Perry, 1990; Shaver & Scott, (1991)	People with an internal locus of control are more likely to engage in entrepreneurial activities.
Watson, A., et al., (2020)	A direct positive link was found between the locus of control and entrepreneurial orientation.

#### IV. RESEARCH METHODOLOGY

##### **A. Operationalization of research variables**

The dependent variable is presented through a one-dimensional construct, which represents the overall attitude of respondents about the propensity for entrepreneurship. The variable is represented linearly, using the Likert scale of 1-7.

The independent variable is presented through a one-dimensional psychological construct of Locus of Control. The instrument for assessing locus of control is measured by the Rotter's Locus of Control scale. The scale is presented categorically, whose score is eventually represented linearly. Rotter's scale of internal versus external locus of control consists of 29 items, with a choice of alternatives a and b. The results on the items are binary variables - 0 and 1, and the total score is expressed as the sum of points on 23 statements (6 items are not scored, they serve to conceal the purpose of the test). The lower score represents the internal locus of control, while the high score represents the external locus of control, and the range of results is 0 - 23 [2].

##### **B. Data on the procedure and sample of the research**

The research was conducted through the mentioned scales. For data processing, the software package for statistical data processing IBM SPSS Statistics 21 was used. The research was conducted during 2020/2021 in Serbia, on a sample of engineering students (N = 108).

##### **C. Methods for data analysis and processing**

The presented research results were obtained by applying statistical procedures. The statistical methods used for data processing are descriptive statistics, correlation analysis and regression analysis.

Descriptive statistics were used to determine average scores at loci of control and propensity towards entrepreneurship. In this way, a general picture of the research was obtained. Correlation analysis was applied to determine the direction and strength of the connection between the locus of control and the propensity for entrepreneurship in the respondents. Regression analysis was applied to determine the predictive effect of the locus of control (independent variable) on the propensity to entrepreneurship (dependent variable).

#### V. RESEARCH RESULTS AND DISCUSSION

Table 2. shows the research results by first describing the research sample through descriptive statistics. Based on Table 2., it can be seen that the arithmetic mean of the predictor (independent) variable of the Locus of Control is 11.14. Such a result can be said to be average, because it reflects the middle of the scale of the internal and external locus of control. The results of the arithmetic mean of the predictor variable directly influenced the average propensity towards entrepreneurship to be 4.11 (in relation to the scale of 1 to 7). The standard deviation, which at the Locus of Control is 5,248 and at the propensity for entrepreneurship 2,075, represents the propensity as much as the average error would be in predicting certain results, i.e. actions of the respondents in the examined actions.

Table 2. Descriptive statistics

<b>Descriptive Statistics</b>			
	Mean	Std. Deviation	N
Entrepreneurship	4,11	2,075	108
Locus of control	11,14	5,248	108

Table 3. Shows the linear correlation, i.e. Pearson's correlation of loci of control and propensity for entrepreneurship. It can be concluded that the correlation has a negative sign (-, 975),



which means that the mentioned variables are negatively related. When looking at the statistical significance of correlations, they are very significantly related at the level of 0.001 (.000).

Table 3. Linear correlation

Correlations			
		Locus of control	Entrepreneurship
Locus of control	Pearson Correlation	1	<b>-,975**</b>
	Sig. (2-tailed)		<b>,000</b>
	N	108	108
Entrepreneurship	Pearson Correlation	<b>-,975**</b>	1
	Sig. (2-tailed)	<b>,000</b>	
	N	108	108

\*\* . Correlation is significant at the 0.01 level (2-tailed).

Table 4. defines the number of models, in this case only 1 model, because there is only one independent variable. It is also defined which is the predictor / independent (Locus of control) and which is the dependent variable (Entrepreneurship).

Table 4. Variables

Variables Entered/Removed <sup>a</sup>			
Model	Variables Entered	Variables Removed	Method
1	Locus of control <sup>b</sup>	.	Enter
a. Dependent Variable: Preduzetništvo			
b. All requested variables entered.			

When looking at Adjusted R Square (0.950) in Table 5, it can be concluded that individuals according to the type of locus of control differ in their preferences for entrepreneurship by as much as 95%. It can also be concluded that when the corrected R square is multiplied by 100, that 95% of the variability is the difference between the type of locus of control of the respondents and that this explains the differences in propensity towards entrepreneurship. The standard error in the model on the predictor variable is 0.466, and when compared with the standard deviation from the descriptive statistics of 5.248 (Table 2), a larger difference can be observed, which gives significance to the model and prediction of the predictor variable.

Tabela 5. Model summary

Model Summary <sup>b</sup>				
Model	R	R Square	Adjusted R Square	Std. Error of the Estimate
1	,975 <sup>a</sup>	,950	,950	,466
a. Predictors: (Constant), Locus of control				
b. Dependent Variable: Preduzetništvo				

Table 6. shows the justification of the regression model, based on the F test, where  $F = 2016,183$  ( $437,657 / 0,247$ ), which results in  $Sig = 0,000$ , which indicates the statistical significance of the model.

Tabela 6. Regression model

ANOVA <sup>a</sup>						
Model	Sum of Squares	df	Mean Square	F	Sig.	
1	Regression	437,657	1	437,657	2016,183	<b>,000<sup>b</sup></b>
	Residual	23,010	106	,217		
	Total	460,667	107			
a. Dependent Variable: Preduzetništvo						
b. Predictors: (Constant), Locus of control						

Table 7. shows the test on the significance of the regression coefficient for the predictor variable ( $B = -,385$ ), the significance of that non-standardized regression coefficient is determined via the T test  $= -44,902$  ( $-,385/0,009$ ). The outcome of the T test, i.e. the significance of the single linear regression is identical to the outcome of the F test (Table 6.), which means that the statistical significance, i.e. the influence of the predictor variable is very statistically significant ( $Sig. 0.000$ ). The predicted result for the propensity for entrepreneurship is equal to 8.404, and the result for the expression of the locus of control type is  $-0.385$  \*.

Tabela 7. Regression analysis coefficients

Coefficients <sup>a</sup>							
Model	Unstandard Coeff.	Standard Coeff.	t	Sig.	95,0% Confidence Interval for B		
					Lower Bound	Upper Bound	
1	Constant	<b>8,404</b>	,106	79,588	,000	8,194	8,613
	Locus of control	<b>-,385</b>	,009	-,975	<b>,000</b>	-,402	-,368

a. Dependent Variable: Preduzetništvo

Based on the presented research results, it can be concluded that the locus of control affects the propensity for entrepreneurship, ie. that there is a statistical significance of the impact ( $Sig 0,000$ ), this conclusion also answers the research question (QR1).

## VI. CONCLUSION

Theoretically, and through previous research, it can be concluded why people differ from each other in relation to the type of locus of control

and inclination towards entrepreneurship. People with an internal locus, who have a predisposition to engage in entrepreneurship, believe that everything depends on them, and thus take actions such as starting their own business. While people with an external locus of control believe that they as individuals cannot influence the outcome in their career and further life so much, therefore their inclination towards entrepreneurship is not expressed. It is important to point out that it cannot be generalized that all persons who have an internal locus of control are entrepreneurs. It often happens that such persons are very successful in leading positions both in society and in business. When looking at the sample of research in the population from which it was taken, it can be concluded that there is a linear relationship between the type of locus of control and the propensity for entrepreneurship, i.e. that the type of locus of control affects the propensity for entrepreneurship. The recommendation for future research would be to expand the number of models, i.e. predictor variables and to see what else affects the propensity for entrepreneurship in an expanded sample.

#### REFERENCES

- [1] Rotter, J.B. (1954). *Social Learning and Clinical Psychology*. Englewood Cliffs, NJ: Prentice Hall.
- [2] Rotter, J.B. (1966). Generalized expectancies for internal versus external control of reinforcement. *Psychological Monographs: General and Applied*, 80, No. 609.
- [3] Qin, Y., Yan, R., & Sun, Y. (2020). The Application of Flipped Classroom Combined With Locus of Control Analysis in Lean Entrepreneurship Education for College Students. *Frontiers in Psychology*, 11, 1–11.
- [4] Sun, H., Ni, W., Teh, P.-L., & Lo, C. (2020). The Systematic Impact of Personal Characteristics on Entrepreneurial Intentions of Engineering Students. *Frontiers in Psychology*, 11, 1–15.
- [5] Agyemang, C. B., Kekesi, E., & Larbi, D. (2020). The Nexus between Locus of Control and Entrepreneurial Intention among Final Year University Students in Ghana. *Gender & Behaviour*, 18(3), 16248–16260.
- [6] Vrban, K. (2020). Utjecaj kreativnosti i lokusa kontrole na poduzetničke namiere studenata Ekonomskog fakulteta u Rijeci (Doctoral dissertation). University of Rijeka. Faculty of Economics and Business).
- [7] Caliendo, M., Fossen, F. M., & Kritikos, A. S. (2009). Risk attitudes of nascent entrepreneurs—new evidence from an experimentally validated survey. *Small Business Economics*, 32(2), 153-167.
- [8] Mueller, S.L., & Thomas, A.S. (2001). Culture and entrepreneurial potential: A nine country study of locus of control and innovativeness. *Journal of Business Venturing*, 16(1), 51-75.
- [9] Sokić, J., & Popov, S. (2019). Osobine ličnosti uspešnih preduzetnika. *TIMS. Acta*, 13(2), 107-116.
- [10] Perry, C. (1990). After further sightings of the Heffalump. *Journal of Managerial Psychology*, 5, 22-31.
- [11] Shaver, K.G., & Scott, L.R. (1991). Person, process, choice: The psychology of new venture creation. *Entrepreneurship Theory and Practice*, 23-45.
- [12] Rizzato, S. de C. e C., & Moran, M. C. (2013). Empreendedorismo e personalidade: o perfil em estudantes brasileiros / Entrepreneurship and personality: profile in Brazilian students. *Revista Psicologia Organizações e Trabalho*, 13(3), 279–291.
- [13] Caliendo, M., Fossen, F.M., & Kritikos, A.S. (2014). Personality characteristics and the decisions to become and stay self-employed. *Small Business Economics*, 42(4), 787-814.
- [14] Gürol, Y., & Atsan, N. (2006). Entrepreneurial characteristics amongst university students: Some insights for entrepreneurship education and training in Turkey. *Education + Training*, 48(1), 25-38.
- [15] Hansemark, O.C. (2003). Need for achievement, locus of control and the prediction of business startups: A longitudinal study. *Journal of Economic Psychology*, 24, 301-319.
- [16] Levine, R., & Rubenstein, Y. (2017). Smart and illicit. Who becomes an entrepreneur and do they earn more? *Quarterly Journal of Economics*, 132(2), 963-1018.
- [17] Barrick, M.R. (2005). Yes, personality matters: Moving on to more important matters. *Human Performance*, 18(4), 359-372.
- [18] McClelland, D. C. (1961). *The achieving society*. New York: Free Press.
- [19] Brockhaus, R.H. Sr. (1982). The Psychology of Entrepreneur. In Kent, C., Sexton, D.L., & Vesper, K.H., *Encyclopedia of Entrepreneurship*, Prentice-Hall, Englewood Cliffs, NJ.
- [20] Brockhaus, R.H., & Horwitz, P.S. (1986). The psychology of the entrepreneur. In D.L. Sexton and R.W. Smilor, eds., *The art and science of entrepreneurship*. Cambridge, MA: Ballinger.
- [21] Shapero, A. (1975). The displaced, uncomfortable entrepreneur. *Psychology Today* 9(6):83–88.
- [22] Krueger, N. & Brazeal, D. (1994). Entrepreneurial potential and potential entrepreneurs. *Entrepreneurship Theory and Practice*, 18(3), 91-104.
- [23] Krueger, N. (1993). The impact of prior entrepreneurial exposure on perceptions of new venture feasibility and desirability. *Entrepreneurship Theory and Practice* 18(1), 5–21.
- [24] Watson, A., Dada, O., López-Fernández, B., & Perrigot, R. (2020). The influence of entrepreneurial personality on franchisee performance: A cross-cultural analysis. *International Small Business Journal: Researching Entrepreneurship*, 38(7), 605–62

# Application for Grape Sales

M. Knežević\*

\* Technical Faculty 'Mihajlo Pupin' Zrenjanin, Serbia  
littlepanda.mk@gmail.com

**Abstract** – The aim of the work is to facilitate the work of the agricultural farming company 'Vinogradi Knežević' in the Republic of Serbia. This agricultural farm is involved in the production of table grape varieties. The app makes it easier to memorize orders for the current season, as well as faster search, resourcefulness, and more extensive sales analysis and static. The analysis was conducted on the basis of an agricultural farm and on that basis an application was created.

## I. INTRODUCTION

Agricultural farming from the Republic of Serbia, "Vinogradi Knežević", deals with the production of table grape varieties. By conducting the examination, certain conclusions have been reached. The survey of agricultural landlords was conducted on the basis of a survey. Of the 21 employees of the agricultural landlord, regardless of qualification or position, results were obtained that 95% of the total confirms that an application that facilitates the sale of grapes is necessary.

The current state of agricultural farming is based on traditional order memorials. That applies to paper and pencil. Often an error occurs because everything is reliant on the human factor. In addition, as an outcome, there is customer dissatisfaction.

The application is written in C#. This programming language is one of the younger object-oriented programming languages. This programming language is intended for developing applications on the .NET Framework platform. [1] The application was built with the help of entity framework set technologies used to develop base-oriented application software. This technique can create an application whose data can be stored in a database. [2]

After implementing the application and a certain test period, the app's users, agricultural landlord employees, pointed out possible updates and improvements to the application.

## II RESEARCH METHODOLOGY

The importance of introducing such an application into the work of agricultural landlords is a contribution to the efficiency and quality of the service. There are not many ready-made solutions to this business problem, therefore it is necessary to create an individual application intended exclusively for this agricultural farm.

### A. Problem and subject of the research

Data collection was done in two ways. The first method included an employee interview while the second method of collecting data was to survey employees with a questionnaire, which noted that the questionnaire was anonymous and that the results obtained would be used exclusively for research work in this territory. Respondents comprise employees of different professions, ages, gender, years of work and the height of professional preparation held in different positions within the agricultural landlord, performing different jobs. Respondents surveyed and interviewed were divided into two large groups. One group of respondents is made up of employees in higher positions in agricultural farming, while the other group of respondents is made up of employees in lower positions in agricultural farming.

Table 1- Structure of respondents

AGE	Number of respondents		
	1	2	Total
to 19 years	2	0	2
of 20 to 25 years	4	1	5
of 26 to 31 years	1	3	4
of 32 to 37 years	0	0	0
of 38 to 43 years	4	2	6
of 44 to 49 years	1	0	1
of 50 to 55 years	0	3	3

Table 2-Qualifying structure

QUALIFICATIONS	1	2	Total
I Basic education	1	0	1
II Semiqualfied Worker	0	0	0
III Skilled Worker	4	0	4
IV Secondary Education (4 years)	7	4	11
V Highly skilled worker	0	0	0
VI Higher Education (1 degree of faculty)	0	2	2
VII Higher Education	0	2	2
VIII Master's Degree	0	0	0
IX PhD	0	1	1

#### B. Research hypothesis

Main hypothesis: An application for the sale of grapes is necessary for the development and increase of the efficiency of this farm, regardless of the position.

Hypothesis 1: Employees with high and higher electrical equipment emphasise a positive attitude towards the need and application of this software in agricultural land.

Hypothesis 2: Employees in lower positions in agricultural farming emphasise a positive attitude towards the need and application of this software in agricultural farming.

#### C. Goals and tasks of the research

The survey surveyed two groups of respondents. One group of respondents included employees in senior positions within the agricultural farm, while the other group of respondents was made up of employees in lower positions in agricultural farming. The survey hypothesis is related to the attitudes of respondents in lower and higher positions within agricultural farming, as well as assumptions from which research work has begun related to the views of respondents of higher and lower qualifications.

Respondents regardless of the group to which they belong agreed that an application that enables wholesale of grapes is necessary for more efficient productivity of agricultural farming. Employees believe this application will enable you to create a more efficient product delivery schedule for customers. As well as memorizing clients and thus monitoring the statistics of regular clients. When showing clients that they are regular customers, it is possible to create certain benefits and thus enable trust clients.

#### D. Research sample

This survey involved 21 workers.

#### E. Research design

The survey was conducted anonymously during work day. This survey was done in January, 2020.

### III SURVEY ANALYSIS

#### 1) Is an app required that allows grape sales?

On this issue, agricultural landlords had the answers offered yes and no.

All the workers, regardless of the group they belong to, responded with a yes.

This means that an app that allows wholesale is needed for all workers regardless of the group they belong to. (Figure 1)

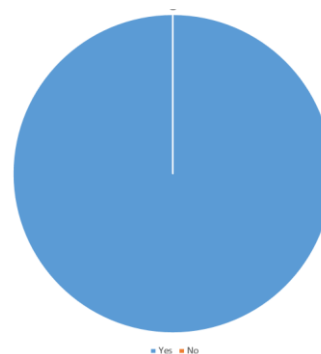

Figure 1- The first question

#### 2) What mitigating factor would the app contribute?

To this question, the workers were able to write multiple answers.

##### a) First group of workers

- Data reliability
- Possibility of insight into regular customers
- Data security achievement
- All in one place
- Gaining speed

##### b) Second group of workers

- Insight into orders
- Delivery method
- Speed of information

#### 3) What details do you need to pay particular attention to?

To this question, the workers were able to write multiple answers.

##### a) First group of workers

- Software startup speed
  - Send data
- b) *Second group of workers*
- Readability
  - Simlicity
  - Availability

#### IV SOFTWARE APPLICATION DEVELOPMENT

Based on analysis and discussions with employees of agricultural farming, "Vineyards Kežević". A framed appearance has occurred to what the application should look like. The created application consists of a set of tables that are linked to each other in a single database. Each table has its own name and data of a specific type. The tables contained in the database are: T\_KUPAC, T\_PORUDZBINA, T\_KUPAC\_PORUDZBINA, T\_ADRESA, T\_VRSTA, T\_ISPORUKA. The database is made up of tables. Each table has its attributes. Each table should contain one of the attributes that will be the primary key to that table.

The application was created from 8 forms: Form1, frmKupac, frmIsporuka, frmVrsta, frmPorudzbina, frmAdresa, frmVrstaPor, frmMestaKupci. Then there are two reports rptKupac i rptVrsta. There are two choices in the main form: Data and Reports. The Data contains five subs. This accesses forms for entering data about addresses, customers, shipments, types, and orders. Whereas within the report there are two subsectors that allow you to view the data for the grape variety that has been ordered and the display of customers who have ordered grapes from where they come from.

The characteristics of the address are: Place, Street and No. All fields are textBox features and data is recorded in them. This form also includes a DataGridView control, which displays data for all added addresses in a database, buttons to add, change, and delete data, and select buttons and give up action on data from a runa way. The Address class.cs is associated with the form of frmAddress.

The following work shows the part of the code that indicates the connection to the database and adds a new housing address to the database itself. The first line of code is a connective string that

enables the connection to the database created in SQL. The add-on() function is then created. With this function, if a base connection is achieved, you can add certain parameters from the form to specific table fields.

```
private string _connectionString = "Data
Source=DESKTOP-
G8DINOL\\SQLEXPRESS;Initial
Catalog=ProdajaBAZA;Integrated Security=True";

public void dodajAdresu()
{
    string insertSql = "INSERT INTO
T_ADRESA " +
        "(Mesto, Ulica, Broj) VALUES " +
        "(@Mesto, @Ulica, @Broj)";
    using (SqlConnection connection = new
SqlConnection(_connectionString))
    {
        SqlCommand command =
connection.CreateCommand();
        command.CommandText = insertSql;
        command.Parameters.Add(new
SqlParameter("@Mesto", Mesto));
        command.Parameters.Add(new
SqlParameter("@Ulica", Ulica));
        command.Parameters.Add(new
SqlParameter("@Broj", Broj));
        connection.Open();
        command.ExecuteNonQuery();
    }
}
```

#### V CONCLUSION

Opportunities for further development of the application, for example, are to add another form of frmRacun where we could enter quantity and price, so that there is a so-called account. It is also possible to introduce maintenance and spraying records of each grape variety, there is also the possibility of creating costs and engaging workers.

#### REFERENCES

- [1] Thuan L. Thai, Hoang Lam, .NetFramework Essentials, O'Reilly 2002,  
D.Lewis, Database systems, University of London, 201

# Grape Vine Protection Record of an Agricultural Holding in Republic of Serbia

M. Knežević\*, N. Bobinac \*

\* Technical Faculty 'Mihajlo Pupin' Zrenjanin, Serbia  
littlepanda.mk@gmail.com, nikolabobinac@gmail.com

**Abstract** – The goal of this paper represent simplifying how the agriguclutral holding „Vinogradi Knežević” from Melenci functions. This agricultural holding produces table varieties of grapes. Because of difficulties of handling paperwork and keeping records. The web aplication shown in this paper enables faster, more efficient and secure way of keeping records for grape vine protection for the following year.

## I. INTRODUCTION

Grape vine has its imunity which needs to be bolstered and maintained constantly. If some product is used more times in a year than it is recommended, the grape vine will develop imunity to it and the imunity of the vine will start growing weaker. Alongside keeping records this web application also notifies the user that a product has been used a maximum number of times this year.

The application is based un multi-layer architecture. The arhitecture is made out of four layers. The first layers is the data access layer, second is the business logic layer, third the service layer and fourth the presentation layer.[1] The presentation layer is also called the user interface and presentation layer. The user interface layer is in charge of showing data to the user, while the presentation logic is in charge of getting that data from deeper layers and formating it for the user layer. The service layer is used as a whole software which provies services to other parts of the application.[2] It represents a layer medium between other layers. The business logic layer defines work units, responsibilities and order of execution. The data access layer is the application layer which access data stored in a type of permanent data storage solution.[3]

In this paper an anlaysis was performed before and after the development of the application. Testing of user acceptance and efficiancy of this application was done in a period of one year. Feedback was gathered from the user base and in that way the application was adequately improved.

## II PREVIOUS WORK

Before development and impementation of the software solution all records of chemical treatments for protection of grape vine were kept in the traditional pen and paper way. This increased the probabiliy of human error which could affect the immunity of grape vine to certain chemical products.

We can imagine grape vine like a human organism. When a human organism is treated with one drug for a longer time it becomes immune to that drug. It is the same with grape vines. When we treat a grape vine with one product it comes to a point where the grape vine becomes immune and the product no longer has effect. [4]

Agricultural holding „Vinogradi Knežević” produces three sorts of table variety grapes on multiple parcels. For each parcel separate protection record are being kept and not each parcel needs the same chemical treatment base on geographical location.

After impementing this multi-layer application the human error factor dropped, the process of recording sped up, it was possible to export data from the database and the visibilite of data was better.

## III SOFTWARE APPLICATION DEVELOPMENT

In this research paper the application was developed using the .Net Framework in ASP.Net to keep records of grape vines. The user, in this case the administrator, can log onto the application with a username and password. Afterwards the user can create, read, update, delete and print records of grape vines and chemical products. Chemical products can be filtered by name. Further images show the user interface.

The database contains three tabels: User, Record and Product. Iser which registers as an administrator can change activities defined in the app itself.

Tebel User has the following columns: *ID*, *Ime*, *Prezime*, *KorisnickoIme*, *Sifra* and *Status*. *ID* is the

primary key and has the value IDENTITY and is set to auto increment for new users. Tabel Product has the fields: *Šifra, Naziv, Doza i Namena*. *Šifra* is the primary key, while it is used as the foreign key in Records. This tabel contains information about chemical products used to treat and protect grape vines. This tabel enables a shorter proces to find instructions for certain chemical products. Also with

business rules the holdings can get precise warning on how many times they can use a product on their vines. Tabel Records serves the purpose of a record base of protection records for all grape vines. The user chooses the record ID, inserts the phase, selects calendar date for treatment and in the last fields selects the product that was used.

Figure 1 . Application user interface

In the further text a part of the code is shown from class `clsPreparatDB`. This class is contained in the layer of class data. With this code data is gathereded from the database. First `NazivPreparata` is defined as a string, then a connection to the database is established. When the connection is established a certain query is executed. It enables filtering and getting all products based on their primary key. (Code 1)

```
public string
DajNazivPremaIDPreparata(string IDPreparata)
{
    string NazivPreparata = "";
    DataSet dsPodaci = new DataSet();
    SqlConnection Veza = new
    SqlConnection(pStringKonekcije);
    Veza.Open();
    SqlCommand Komanda = new
    SqlCommand("DajPreparatePoSifri", Veza);
    Komanda.CommandType =
    CommandType.StoredProcedure;
    Komanda.Parameters.Add("@SifraPreparata",
    SqlDbType.Char).Value = IDPreparata;
    SqlDataAdapter da = new
    SqlDataAdapter();
    da.SelectCommand = Komanda;
    da.Fill(dsPodaci);
    Veza.Close();
    Veza.Dispose();
}
```

```
NazivPreparata =
dsPodaci.Tables[0].Rows[0].ItemArray[1].ToString();
return NazivPreparata;
}
```

Code 1 –`clsPreparatDB.cs`

Business logic is based on the public class `Business Rules Engine` for executing business rules, external business rules written in formal language, while `DLL` library class with algorithms to check and apply business rules.[5] That is the model of business rules and objects where classes represent business objects. In this business rule we check if there is space for adding a new contestant in a given competition.

The concept is invisioned so that it has the goal to retain the immunity of the grape vine to certain chemical products. For that a number is defined how many times per year a plant can be treated with a certain produt. When the treatment is recorder with a certain product. With mappers we get Ids of products from the database and send them to the web service. In the web service we get the maximum number of record for this product in the given record, the record journal. The Web service then checks with XML and gets values after which the two numbers are compared and a responses is returned based on business rules (Code 2)

```
using System;
using System.Collections.Generic;
using System.Linq;
using System.Text;
using KlasePodataka;
using KlaseMapiranja;
namespace PoslovnaLogika
{
    public class clsPoslovnaPravila
    {
        private string pStringKonekcije;
        public clsPoslovnaPravila(string
NoviStringKonekcije)
        {
            pStringKonekcije =
NoviStringKonekcije;
        }
        public bool
DaLiImaMestaZaPonovnoKoriscenjePreparatom(st
ring IDPreparataIzBazePodataka)
        {
            bool mozeOpet = false;

            int
UkupanBrojKoriscenjaPreparata = 0;
            clsEvidencijaDB objEvidencijaDB
= new clsEvidencijaDB(pStringKonekcije);
```

```
UkupanBrojKoriscenjaPreparata =
objEvidencijaDB.DajUkupnoEvidencijaZaPrepara
te(IDPreparataIzBazePodataka);
string IDPreparatWS = "";
        clsMapper objMapper = new
clsMapper(pStringKonekcije);
            IDPreparatWS =
objMapper.DajSifruPreparataZaWebServis(IDPrep
arataIzBazePodataka);
            WSKadrovskiPodaci.Service1 objOgranicenja =
new WSKadrovskiPodaci.Service1();
                int MaxBrojKoriscenjaPreparata =
objOgranicenja.DajMaxBrojKoriscenjaPreparata
(IDPreparatWS);
                    if(UkupanBrojKoriscenjaPreparata
< MaxBrojKoriscenjaPreparata)
                        {
                            mozeOpet = true; }
                        else
                        {
                            mozeOpet = false;
                        }
                    return mozeOpet;
                }
            }
        }
```

Code 2- clsPoslovnoPravilo.cs

#### IV. CONCLUSION

There are many ways in which this application can be further developed. Specific properties of each variety of vines can be added, addition of product prices. If the product price is added then it will be possible at the end of the year to see the total cost of protecting grape vines. If the vineyard parcels expand it is possible to add a field for parcel code and add properties for parcels.

#### REFERENCES

- [1] Pallavi Sethi, Smurti R. Sarangi, Internet of Things: Architectures, Protocols and Applications, Journal of Electrical and Computer Engineering, 2017,
- [2] Kazi Ljubica, RAdulovic Biljana, Projektovanje informacionih sistema kroz primere i zadatke, Tehnicki fakultet Mihajlo Pupin, 2007,
- [3] Dragica Radosav, Softversko inzenjerstvo, Tehnicki Fakultet „Mihajlo Pupin”, Zrenjanin, 2011,
- [4] Stanko Nekić, Zastita vocnjaka i vinove loze i koncept integralne zastite, Svilajnac, 2011,
- [5] [https://www.tutorialspoint.com/software\\_architecture\\_design/key\\_principles.htm](https://www.tutorialspoint.com/software_architecture_design/key_principles.htm)



# ***KNOWLEDGE FOR NEW AGE***



**[www.tfzr.rs](http://www.tfzr.rs)**

ISBN: 978-86-7672-351-5